



Coastal Stormwater Supplement to the Georgia Stormwater Management Manual

First Edition
April 2009



(Source: Georgia Department of Economic Development)



(Source: Center for Watershed Protection)



(Source: Georgia Department of Economic Development)

Coastal Stormwater Supplement to the Georgia Stormwater Management Manual

First Edition
April 2009

Prepared By:
Center for Watershed Protection
8390 Main Street, 2nd Floor
Ellicott City, MD 21043

The development of this Coastal Stormwater Supplement was facilitated by the Chatham County-Savannah Metropolitan Planning Commission. It was funded as a cooperative effort between the Chatham County-Savannah Metropolitan Planning Commission, the Georgia Department of Natural Resources Environmental Protection Division and, through stakeholder outreach and involvement, the cities and counties of coastal Georgia.

This project was financed, in part, through a grant from the U.S. Environmental Protection Agency under the Provisions of Section 319(h) of the Federal Water Pollution Control Act, as amended. This project was also financed, in part, by the Coastal Management and Coastal Nonpoint Source Management Programs of the Georgia Department of Natural Resources and the U.S. Department of Commerce National Oceanic and Atmospheric Administration.

This document was prepared under grant award #NA06NOS4190253 from the Office of Ocean and Coastal Resource Management in the National Oceanic and Atmospheric Administration. The statements, findings, conclusions and recommendations are those of the author(s) and do not necessarily reflect the views of OCRM or NOAA.



THIS PAGE INTENTIONALLY LEFT BLANK

Foreword

Preface

Prior to the 1980s, stormwater management was synonymous with flood control. Post-construction stormwater management systems consisted primarily of pipes designed to convey stormwater runoff directly to rivers, streams and other aquatic resources. Flood control basins were occasionally installed to reduce peak discharge rates and alleviate localized and downstream flooding, but little thought was given to stormwater quality. Although this stormwater management approach worked well to reduce flooding and protect public safety, it did not address the wider range of negative impacts that land development can have on the health of rivers, streams and other aquatic resources.

During the 1980s, communities began to realize that, in order to better protect aquatic resources from the negative impacts of the land development process, both stormwater quantity *and* stormwater quality had to be addressed. With the introduction of Phase I of the National Pollutant Discharge Elimination System (NPDES) Stormwater Program in 1990, and Phase II of the NPDES Stormwater Program in 1999, communities began to revise and expand their local stormwater management programs. The programs that these communities developed focused on *managing* stormwater quantity and quality and tended to rely heavily on traditional stormwater management practices, such as wet and dry ponds, to *mitigate*, rather than *prevent*, the negative impacts of the land development process.

Since then, a number of communities around the country have concluded that “an ounce of prevention is worth a pound of cure.” They have been working to shift the focus away from the *mitigation* of the negative impacts of the land development process and place it on their *prevention*, by creating post-construction stormwater management programs that successfully integrate stormwater management and natural resource protection with the site planning and design process. These communities are increasingly using their stormwater management programs to protect and/or restore valuable natural resources, create attractive public and private spaces and engage residents and businesses in environmental stewardship.

Picking up on this national trend, this Coastal Stormwater Supplement (CSS) to the Georgia Stormwater Management Manual (GSMM) provides information that can be used to shift the focus of coastal Georgia’s post-construction stormwater management efforts onto the *prevention*, rather than the *mitigation*, of the negative impacts of the land development process. It provides Georgia’s coastal communities with comprehensive guidance on an integrated, *green infrastructure*-based approach to natural resource protection, stormwater management and site design that can be used to better protect coastal Georgia’s unique and vital natural resources from the negative impacts of land development and nonpoint source pollution.

Acknowledgements

The development of this CSS was facilitated by the Chatham County-Savannah Metropolitan Planning Commission. It represents the culmination of a cooperative, collaborative effort between the Chatham County-Savannah Metropolitan Planning Commission, the Georgia Department of Natural Resources Environmental Protection Division and, through stakeholder outreach and involvement, the cities and counties of coastal Georgia, including:

Appling County	Long County
Atkinson County	McIntosh County
Bacon County	Pierce County
Bryan County	Tattnall County
Brantley County	Toombs County
Bulloch County	Ware County
Camden County	Wayne County
Candler County	City of Savannah
Charlton County	City of Garden City
Chatham County	City of Richmond Hill
Clinch County	City of Hinesville
Coffee County	City of Jesup
Effingham County	City of Brunswick
Evans County	City of Darien
Glynn County	City of Kingsland
Jeff Davis County	City of St. Mary's
Liberty County	

This project was financed, in part, through a grant from the U.S. Environmental Protection Agency under the Provisions of Section 319(h) of the Federal Water Pollution Control Act, as amended. This project was also financed, in part, by the Coastal Management and Coastal Nonpoint Source Management Programs of the Georgia Department of Natural Resources and the U.S. Department of Commerce National Oceanic and Atmospheric Administration.

Individuals contributing to the development of this CSS included:

- Michael Novotney (Center for Watershed Protection), Project Manager and Lead Author
- Kelly Collins and Greg Hoffman (Center for Watershed Protection)

Tim Carter and the University of Georgia River Basin Center deserve special recognition for their contribution to the development of this CSS. They provided assistance with the creation of the stormwater utility handbook and model post-construction stormwater management ordinance that accompany this document.

A special thank you is also extended to the following individuals, whose thoughtful comments and insights on this document greatly improved its organization and utility:

- Jeannie Lewis Rhodes (Georgia Department of Natural Resources)
- Jackie Jackson Teel (Chatham County-Savannah Metropolitan Planning Commission)
- Bill Hodgins (City of Savannah)
- Dan Hitchcock (Clemson University)
- Dave Briglio (MACTEC Engineering and Consulting, Inc.)
- Dave Hirschman (Center for Watershed Protection)
- Keren Giovengo (University of Georgia Marine Extension Service)
- Jon Ambrose (Georgia Department of Natural Resources)
- Michelle Vincent (Georgia Department of Natural Resources)
- Angela Westin (Georgia Department of Natural Resources)

Thanks are also due to everyone who took the time and effort to provide comments and suggestions on earlier drafts of this CSS, including all of the stakeholders who met several times over the course of eighteen months to review the progress of the CSS and provide invaluable feedback to the development team:

Brannyn Allen	Christa Frangiamore	Brannen Parcel
Jill Andrews	Jim Freeman	Billy Joe Parker
Sarah Barmeyer	Sarah Gaines Barmeyer	Randy Payne
Laura Barrett	Dan Gay	George Peters
Jan Bass	Jim Gilbert	Nate Pierce
Gregg Bayard	Gene Giovanco	Bill Piper
Travis Bazemore	Denise Grabowski	Raymond Pittman
Amy Bell	Suzie Grams	Luke Potts
Brett Bennett	Randall Griffin	Adam Ragsdale
Will Berson	Nicole Grissett	Chris Rains
Aaron Bivins	Warren Hankinson	Butch Register
Joe Bolt	Tom Havens	Courtney Reich
Scott Brazell	Dan Hawthorne	Tricia Reynolds
Carey Brown	Rachael Hodge	Ray Richard
Donald Brown	Katie Hoover Alvarado	Gordon Rogers
Jim Bruner	Nate Hunt	Marcus Rubenstein
Travis Burke	Dennis Hutton	Bill Sapp
Jason Butler	Loretta Hylton	Polly Sattler
John Butts	Larry Jones	Matt Saxon
Steve Byrd	Phillip Jones	Bill Shanahan
Dale Caldwell	Bob Joyner	Pete Shonka
Chris Carroll	Jeff King	Lonny Shook
John Carswell	Jeff Kirkland	Bill Shuman
Tom Cetti	Todd Kline	Gary Shuman
C.J. Chance	Jennifer Kline	Paul Simonton
Kathy Chapman	Bob Klink	Luther Smart
Rick Charnock	David Kyler	Dick Smith
Conn Cole	Christine Laporte	Kelly Spratt
Sam Collier	Wayne Lee	Stuart Stevens
James Collins	Sarah Lewis	Kirk Tatum
Teresa Concannon	Jennifer Little	Jennifer Taylor
Lynette Cook	Sarah Lumpkin	Bob Thomson
Luther Cosner	Robert Mack	Tom Thomson
Christopher Cox	Ryan Madson	Susan Todd
Darrell Crosby	Tayna Mandel	Bill Uhl
Downer Davis	Robert Marr	Suzanne Van Parreren
Mike Davis	Dan McFee	Alice Vick
John Day	Christine McKay	Sam Vick
Mike DeMell	Neil McKenzie	Julie Walden
Deatre Denion	Charles McMillian	Laura Walker
Travis Douce	Tara Merrill	Andy Weber
Dale Dudley	Alec Metzger	Diana Wedincamp
Sanford Elton	Nick Millionis	Ann Welch
Sonny Emmert	Warren Milliken	Gil Wertz
Rowland Eskridge	Russell Moncrief	Joseph White
Charles Ezelle	Kelie Moore	Megan Williams
John Farmer	Ebrahim Nadji	Michael Willouby
Jian Fei	David Nash	Joe Wilson
Ron Feldner	Mark Nelson	Steve Wohlfeil
Dan Fischer	Nick Ogden	Paul Wolff
Janice Flory	Ray O'Neill	Jim Wright
Bill Foster Jr.	Kelly O'Rourke	John Wynne

Finally, a special thank you is extended to the many communities, agencies and individuals who worked so hard to create and publish the GSMM back in 2001. Those of you that are familiar with the GSMM will quickly realize that this CSS builds on the valuable information that is presented within that document. Without the GSMM, this CSS would have required much more time, money and effort to create.

This document was prepared under grant award #NA06NOS4190253 from the Office of Ocean and Coastal Resource Management in the National Oceanic and Atmospheric Administration. The statements, findings, conclusions and recommendations are those of the author(s) and do not necessarily reflect the views of OCRM or NOAA.

Table of Contents

Title Page.....	i
Foreword	iii
Table of Contents	vii
List of Tables.....	xiii
List of Figures.....	xvii
List of Text Boxes.....	xxi
1.0 Introduction.....	1-1
1.1 Background	1-1
1.2 Applicability of the Supplement	1-2
1.3 Purpose the Supplement.....	1-3
1.4 Organization of the Supplement	1-4
1.5 Regulatory Status of the Supplement.....	1-5
1.6 Relationship of the Supplement to the Georgia Stormwater Management Manual	1-5
1.7 How to Get Copies of the Supplement.....	1-6
1.8 How to Find the Supplement on the Internet	1-7
1.9 Contact Information.....	1-7
References.....	1-8
2.0 Coastal Natural Resources	2-1
2.1 Overview	2-1
2.2 Aquatic Resources.....	2-1
2.2.1 Freshwater Resources.....	2-1
2.2.1.1 Rivers and Streams.....	2-1
2.2.1.2 Freshwater Wetlands	2-2
2.2.2 Estuarine Resources.....	2-4
2.2.2.1 Tidal Rivers.....	2-4
2.2.2.2 Sounds	2-4
2.2.2.3 Tidal Creeks.....	2-5
2.2.2.4 Coastal Marshlands	2-5
2.2.2.5 Tidal Flats	2-6
2.2.2.6 Scrub-Shrub Wetlands	2-7
2.2.3 Marine Resources	2-7
2.2.3.1 Near Coastal Waters	2-7
2.2.3.2 Beaches	2-7
2.2.4 Groundwater Resources	2-8
2.2.4.1 Groundwater Aquifers.....	2-8
2.3 Terrestrial Resources.....	2-8
2.3.1 Dunes	2-9
2.3.2 Maritime Forests	2-9
2.3.3 Marsh Hammocks	2-10
2.3.4 Evergreen Hammocks.....	2-10
2.3.5 Canebreaks.....	2-10
2.3.6 Bottomland Hardwood Forests	2-11
2.3.7 Beech-Magnolia Forests	2-11
2.3.8 Pine Flatwoods.....	2-11
2.3.9 Longleaf Pine-Wiregrass Savannas.....	2-12

2.3.10 Longleaf Pine-Scrub Oak Woodlands.....	2-13
2.4 Other Resources.....	2-13
2.4.1 Shellfish Harvesting Areas	2-13
2.4.2 Aquatic Buffers.....	2-13
2.4.3 Floodplains.....	2-14
2.5 Summary	2-14
References.....	2-15
3.0 The Need for Natural Resource Protection and Stormwater Management.....	3-1
3.1 Overview.....	3-1
3.2 Direct Impacts of Land Development.....	3-2
3.3 Indirect Impacts of Land Development.....	3-2
3.3.1 Effects of Land Development on Stormwater Runoff	3-3
3.3.2 Effects of Land Development on Aquatic Resources.....	3-6
3.3.2.1 Effects of Land Development on Freshwater Resources	3-6
3.3.2.2 Effects of Land Development on Estuarine Resources.....	3-10
3.3.2.3 Effects of Land Development on Marine Resources	3-11
3.3.2.4 Effects of Land Development on Groundwater Resources	3-12
3.4 Addressing the Impacts with Natural Resource Protection and Stormwater Management.....	3-13
References.....	3-14
4.0 Stormwater Management and Site Planning and Design Criteria	4-1
4.1 Overview	4-1
4.2 Applicability and Exemptions.....	4-1
4.2.1 Applicability.....	4-1
4.2.2 Exemptions	4-2
4.3 Site Planning and Design Criteria.....	4-2
4.3.1 SP&D Criteria #1: Natural Resources Inventory.....	4-3
4.3.2 SP&D Criteria #2: Use of Green Infrastructure Practices.....	4-4
4.3.3 SP&D Criteria #3: Stormwater Management Concept Plan.....	4-8
4.3.4 SP&D Criteria #4: Stormwater Management Design Plan.....	4-9
4.3.5 SP&D Criteria #5: Downstream Analysis.....	4-11
4.3.6 SP&D Criteria #6: Stormwater Management System Inspection and Maintenance Plan... ..	4-11
4.3.7 SP&D Criteria #7: Erosion and Sediment Control Plan	4-12
4.3.8 SP&D Criteria #8: Landscaping Plan	4-12
4.3.9 SP&D Criteria #9: Stormwater Pollution Prevention Plan.....	4-12
4.4 Post-Construction Stormwater Management Criteria.....	4-13
4.4.1 SWM Criteria #1: Stormwater Runoff Reduction	4-14
4.4.2 SWM Criteria #2: Stormwater Quality Protection.....	4-16
4.4.3 SWM Criteria #3: Aquatic Resource Protection.....	4-17
4.4.4 SWM Criteria #4: Overbank Flood Protection	4-19
4.4.5 SWM Criteria #5: Extreme Flood Protection	4-20
4.5 Special Stormwater Management and Site Planning and Design Criteria	4-20
4.5.1 Special Criteria for Shellfish Harvesting Areas	4-20
4.5.1.1 Special Criteria #1: Increased Stormwater Runoff Reduction	4-20
4.5.1.2 Special Criteria #2: Enhanced Aquatic Resource Protection.....	4-21
4.6 Summary	4-21
References.....	4-24

5.0	Calculating the Stormwater Runoff Volumes Associated with the Stormwater Management Criteria	5-1
5.1	Overview	5-1
5.2	Calculating the Stormwater Runoff Volume Associated with the Stormwater Runoff Reduction Criteria (SWM Criteria #1)	5-1
5.3	Calculating the Stormwater Runoff Volume Associated with the Water Quality Protection Criteria (SWM Criteria #2)	5-3
5.4	Calculating the Stormwater Runoff Volume Associated with the Aquatic Resource Protection Criteria (SWM Criteria #3)	5-4
5.4.1	Step 1: Determine the Amount of Rainfall Generated by the 1-Year, 24-Hour Storm Event.....	5-4
5.4.2	Step 2: Determine the Runoff Curve Number for the Development Site Under Post-Development Conditions	5-4
5.4.2.1	Runoff Curve Numbers	5-7
5.4.3	Step 3: Compute the Stormwater Runoff Volume Generated by the 1-Year, 24-Hour Storm Event Under Post-Development Conditions.....	5-11
5.4.4	Step 4: Determine the Initial Abstraction and Initial Abstraction Ratio Under Post-Development Conditions	5-11
5.4.5	Step 5: Determine the Time of Concentration for the Development Site Under Post-Development Conditions	5-12
5.4.6	Step 6: Compute the Uncontrolled Peak Discharge Under Post-Development Conditions	5-16
5.4.7	Step 7: Determine the Ratio of the Controlled Peak Discharge to the Uncontrolled Peak Discharge	5-21
5.4.8	Step 8: Calculate the Ratio of the Required Storage Volume to the Stormwater Runoff Volume	5-23
5.4.9	Step 9: Determine the Required Storage Volume	5-25
5.5	Calculating the Stormwater Runoff Volume Associated with the Overbank Flood Protection Criteria (SWM Criteria #4)	5-25
5.6	Calculating the Stormwater Runoff Volume Associated with the Extreme Flood Protection Criteria (SWM Criteria #5)	5-27
	References.....	5-30
6.0	Satisfying the Stormwater Management and Site Planning and Design Criteria	6-1
6.1	Overview	6-1
6.2	Site Planning and Design Process	6-2
6.3	Integrating Natural Resource Protection and Stormwater Management with the Site Planning and Design Process	6-4
6.3.1	Step 1: Pre-Application Meeting	6-7
6.3.2	Step 2: Review of Local, State and Federal Stormwater Management and Site Planning and Design Requirements	6-7
6.3.3	Step 3: Natural Resources Inventory.....	6-8
6.3.4	Step 4: Prepare Stormwater Management Concept Plan	6-10
6.3.4.1	Step 4.1: Use Better Site Planning Techniques	6-12
6.3.4.2	Step 4.2: Use Better Site Design Techniques	6-15
6.3.4.3	Step 4.3: Calculate Stormwater Management Criteria	6-18
6.3.4.4	Step 4.4: Apply Low Impact Development Practices	6-19
6.3.4.5	Step 4.5: Check to See If Stormwater Management Criteria Have Been Met.....	6-27
6.3.4.6	Step 4.6: Apply Stormwater Management Practices.....	6-27

5.3.4.7	Step 4.7: Check to See If Stormwater Management Criteria Have Been Met.....	6-37
5.3.4.8	Step 4.8: Finalize Stormwater Management Concept Plan	6-37
6.3.5	Step 5: Consultation Meeting.....	6-37
6.3.6	Step 6: Prepare Stormwater Management Design Plan	6-38
6.3.7	Beyond the Stormwater Management Design Plan	6-39
6.4	Meeting the Stormwater Management and Site Planning and Design Criteria on Local Road, Highway and Bridge Development Projects.....	6-39
6.4.1	Local Highway Development Projects	6-41
6.4.2	Local Bridge Development Projects.....	6-42
6.4.3	Local Street and Roadway Development Projects.....	6-42
6.4.4	Local Back (Dirt and Gravel) Road Development Projects	6-42
	References.....	6-44
7.0	Green Infrastructure Practices.....	7-1
7.1	Overview	7-1
7.2	Recommended Green Infrastructure Practices.....	7-2
7.3	Other Green Infrastructure Practices	7-4
7.3.1	New and Innovative Green Infrastructure Practices	7-4
7.4	Applying Green Infrastructure Practices During the Site Planning & Design Process.....	7-4
7.4.1	Step 4.1: Use Better Site Planning Techniques.....	7-4
7.4.2	Step 4.2: Use Better Site Design Techniques	7-6
7.4.3	Step 4.3: Calculate Stormwater Management Criteria	7-7
7.4.4	Step 4.4: Apply Low Impact Development Practices	7-7
7.4.5	Step 4.5: Check to See If Stormwater Management Criteria Have Been Met	7-8
7.5	Green Infrastructure Practice Selection.....	7-8
7.5.1	Step 1: Evaluate Ability to Help Satisfy the Stormwater Mangement Criteria	7-9
7.5.2	Step 2: Evaluate Overall Feasibility	7-16
7.5.3	Step 3: Evaluate Site Applicability	7-20
7.6	Better Site Planning Technique Profile Sheets.....	7-23
7.6.1	Protect Primary Conservation Areas	7-25
7.6.2	Protect Secondary Conservation Areas	7-29
7.7	Better Site Design Technique Profile Sheets	7-33
7.7.1	Reduce Clearing and Grading Limits	7-35
7.7.2	Reduce Roadway Lengths and Widths	7-39
7.7.3	Use Fewer or Alternative Cul-de-Sacs.....	7-43
7.7.4	Reduce Parking Lot Footprints	7-47
7.7.5	Create Landscaping Areas in Parking Lots	7-51
7.7.6	Reduce Driveway Lengths and Widths.....	7-53
7.7.7	Reduce Sidewalk Lengths and Widths.....	7-55
7.7.8	Reduce Building Footprints.....	7-57
7.7.9	Reduce Setbacks and Frontages.....	7-59
7.8	Low Impact Development Practice Profile Sheets	7-63
7.8.1	Soil Restoration	7-65
7.8.2	Site Reforestation/Revegetation	7-71
7.8.3	Green Roofs.....	7-77
7.8.4	Permeable Pavements	7-85
7.8.5	Undisturbed Pervious Areas.....	7-95
7.8.6	Vegetated Filter Strips	7-101
7.8.7	Grass Channels	7-109
7.8.8	Simple Downspout Disconnection.....	7-117

7.8.9 Rain Gardens	7-125
7.8.10 Stormwater Planters.....	7-135
7.8.11 Dry Wells.....	7-143
7.8.12 Rainwater Harvesting	7-151
7.8.13 Bioretention Areas	7-157
7.8.14 Infiltration Practices	7-163
7.8.15 Dry Swales.....	7-169
References.....	7-175

8.0 Stormwater Management Practices.....8-1

8.1 Overview	8-1
8.2 Recommended Stormwater Management Practices	8-2
8.2.1 General Application Practices	8-2
8.2.2 Limited Application Practices	8-4
8.3 Other Stormwater Management Practices.....	8-5
8.3.1 Not Recommended Stormwater Management Practices	8-5
8.3.2 New and Innovative Stormwater Management Practices.....	8-5
8.4 Applying Stormwater Management Practices During the Site Planning & Design Process.....	8-5
8.4.1 Step 4.6: Apply Stormwater Management Practices	8-5
8.4.2 Step 4.7: Check Post-Construction Stormwater Management Criteria	8-7
8.5 Stormwater Management Practice Selection	8-8
8.5.1 Step 1: Evaluate Ability to Help Satisfy the Stormwater Management Criteria	8-8
8.5.2 Step 2: Evaluate Overall Feasibility	8-14
8.5.3 Step 3: Evaluate Site Applicability	8-17
8.6 General Application Stormwater Management Practice Profile Sheets.....	8-19
8.6.1 Stormwater Ponds.....	8-21
8.6.2 Stormwater Wetlands.....	8-35
8.6.3 Bioretention Areas	8-47
8.6.4 Filtration Practices.....	8-59
8.6.5 Infiltration Practices	8-69
8.6.6 Swales	8-83
8.7 Limited Application Stormwater Management Practice Profile Sheets	8-93
References.....	8-95

9.0 Local Post-Construction Stormwater Management Programs9-1

9.1 Overview	9-1
9.2 Developing an Effective Local Post-Construction Stormwater Management Program.....	9-1
9.3 Step 1: Program Planning.....	9-4
9.3.1 Step 1.1: Assess Community and Its Watersheds	9-4
9.3.2 Step 1.2: Assess Existing Stormwater Management Program.....	9-5
9.3.3 Step 1.3: Develop Program Goals and Objectives	9-6
9.3.4 Step 1.4: Develop Implementation Plan and Preliminary Budget	9-7
9.4 Step 2: Develop a Stormwater Management Approach.....	9-10
9.4.1 Step 2.1: Develop an Approach to Address Stormwater Management at the Site Scale.....	9-10
9.4.2 Step 2.2: Develop Supporting Stormwater Management and Site Planning & Design Criteria	9-10

9.4.3	Step 2.3: Develop an Approach to Address Stormwater Management at the Watershed Scale	9-11
9.5	Step 3: Develop Post-Construction Stormwater Management Ordinance.....	9-13
9.6	Step 4: Develop Stormwater Guidance Manual	9-13
9.7	Step 5: Develop a Plan Review and Approval Process.....	9-14
9.7.1	Step 5.1: Scope Out Plan Review and Approval Process.....	9-15
9.7.2	Step 5.2: Create Permit Applications, Instructions and Checklists	9-15
9.7.3	Step 5.3: Forecast Staff Needs and Acquire Plan Review Staff	9-16
9.7.4	Step 5.4: Provide Training for Plan Reviewers and Site Designers	9-16
9.7.5	Step 5.5: Set Up Performance Bond Process, Forms and Tracking System.....	9-16
9.8	Step 6: Develop Construction Inspection Program	9-17
9.8.1	Step 6.1: Scope Out the Inspection Process	9-17
9.8.2	Step 6.2: Create Checklists and As-Built Certification Forms.....	9-18
9.8.3	Step 6.3: Forecast Staff Needs and Acquire Inspection Staff	9-18
9.8.4	Step 6.4: Provide Training for Inspectors and Contractors.....	9-19
9.9	Step 7: Develop Inspection and Maintenance Program.....	9-19
9.9.1	Step 7.1: Scoping the Inspection and Maintenance Program	9-20
9.9.2	Step 7.2: Create Checklists, Inspection Forms and Enforcement Tools	9-20
9.9.3	Step 7.3: Forecast Staff Needs and Acquire Inspection Staff	9-21
9.9.4	Step 7.4: Create and Disseminate Outreach Materials for Responsible Parties.....	9-21
9.10	Step 8: Develop Program Tracking and Evaluation System	9-21
9.10.1	Step 8.1: Develop a Framework for Program Tracking and Evaluation.....	9-22
9.10.2	Step 8.2: Develop Program Tracking and Evaluation Protocols	9-23
9.10.3	Step 8.3: Write Annual Reports.....	9-23
9.11	Summary	9-24
	References.....	9-25
	Glossary	10-1
	Appendix A High Priority Plant and Animal Species and Habitat Areas	A-1
	Appendix B Coastal Georgia Rainfall Analysis	B-1
	Appendix C Coastal Stormwater Management Practice Monitoring Protocol.....	C-1
	Appendix D Model Post-Construction Stormwater Management Ordinance	D-1

List of Tables

3.0 The Need for Natural Resource Protection and Stormwater Management

3.1	Projected Population Growth in the 10-County Population Study Area	3-1
-----	--	-----

4.0 Stormwater Management and Site Planning and Design Criteria

4.1	Summary of the Site Planning and Design Criteria	4-2
4.2	Resources to be Identified and Mapped During the Natural Resources Inventory	4-4
4.3	Primary Conservation Areas	4-7
4.4	Secondary Conservation Areas	4-8
4.5	Summary of the Post-Construction Stormwater Management Criteria	4-13
4.6	Allowable Uses Associated with the Multi-Zone Aquatic Buffer System.....	4-19
4.7	How the Criteria Help Address the Negative Impacts of the Land Development Process.....	4-23

5.0 Calculating the Stormwater Runoff Volumes Associated with the Stormwater Management Criteria

5.1	Classifying Hydrologic Soil Groups According to Soil Texture	5-5
5.2	Antecedent Moisture Conditions and Seasonal Rainfall Limits	5-7
5.3	Runoff Curve Numbers for Urban Lands.....	5-8
5.4	Runoff Curve Numbers for Cultivated Agricultural Lands.....	5-9
5.5	Runoff Curve Numbers for Other Agricultural Lands	5-10
5.6	Initial Abstraction Values for Runoff Curve Numbers.....	5-11
5.7	Manning's Roughness Coefficients for Sheet Flow	5-13
5.8	Adjustment Factor (F_p) for Pond and Swamp Areas That Are Spread Across a Development Site.....	5-17
5.9	Calculating the Stormwater Runoff Volume Associated with the Overbank Flood Protection Criteria	5-26
5.10	Calculating the Stormwater Runoff Volume Associated with the Extreme Flood Protection Criteria	5-28

6.0 Satisfying the Stormwater Management and Site Planning and Design Criteria

6.1	How Better Site Planning Techniques Can Be Used To Help Satisfy the Stormwater Management Criteria.....	6-14
6.2	How Better Site Design Techniques Can Be Used to Help Satisfy the Stormwater Management Criteria.....	6-17
6.3	Ability of Low Impact Development and Stormwater Management Practices to Reduce Annual Stormwater Runoff Volumes and Pollutant Loads.....	6-21
6.4	How Low Impact Development Practices Can Be Used to Help Satisfy the Stormwater Management Criteria	6-22
6.5	How Stormwater Management Practices Can Be Used to Help Satisfy the Stormwater Management Criteria	6-33

7.0 Green Infrastructure Practices

7.1	How Green Infrastructure Practices Can Be Used to Help Satisfy the Stormwater Management Criteria.....	7-10
7.2	Factors to Consider When Evaluating the Overall Feasibility of Green Infrastructure Practices.....	7-17
7.3	Factors to Consider When Evaluating the Applicability of Green Infrastructure Practices on a Development Site	7-21
7.4	Impervious Cover Created by Various Turnaround Options	7-44
7.5	Conventional Minimum Parking Ratios.....	7-48
7.6	Factors to Consider When Evaluating the Overall Feasibility of Using Soil Restoration on a Development Site.....	7-67
7.7	Routine Maintenance Activities Typically Associated with Soil Restoration	7-69
7.8	Factors to Consider When Evaluating the Overall Feasibility of Using Site Reforestation/Revegetation on a Development Site.....	7-73
7.9	Routine Maintenance Activities Typically Associated with Site Reforestation/Revegetation.....	7-75
7.10	Factors to Consider When Evaluating the Overall Feasibility of Using a Green Roof on a Development Site	7-80
7.11	Routine Maintenance Activities Typically Associated with Green Roofs.....	7-82
7.12	Factors to Consider When Evaluating the Overall Feasibility of Using a Permeable Pavement System on a Development Site.....	7-89
7.13	Challenges Associated with Using Permeable Pavement Systems in Coastal Georgia	7-90
7.14	Routine Maintenance Activities Typically Associated with Permeable Pavement Systems.....	7-93
7.15	Factors to Consider When Evaluating the Overall Feasibility of Using Undisturbed Pervious Areas to “Receive” Stormwater Runoff on a Development Site	7-97
7.16	Routine Maintenance Activities Typically Associated with Undisturbed Pervious Areas Used to “Receive” Stormwater Runoff	7-100
7.17	Factors to Consider When Evaluating the Overall Feasibility of Using a Vegetated Filter Strip on a Development Site	7-104
7.18	Challenges Associated with Using Vegetated Filter Strips in Coastal Georgia.....	7-105
7.19	Routine Maintenance Activities Typically Associated with Vegetated Filter Strips	7-108
7.20	Factors to Consider When Evaluating the Overall Feasibility of Using a Grass Channel on a Development Site	7-112
7.21	Challenges Associated with Using Grass Channels in Coastal Georgia.....	7-113
7.22	Routine Maintenance Activities Typically Associated with Grass Channels	7-116
7.23	Factors to Consider When Evaluating the Overall Feasibility of Using a Simple Downspout Disconnection on a Development Site	7-120
7.24	Challenges Associated with Using Simple Downspout Disconnections in Coastal Georgia	7-120
7.25	Routine Maintenance Activities Typically Associated with Simple Downspout Disconnections	7-123
7.26	Factors to Consider When Evaluating the Overall Feasibility of Using a Rain Garden on a Development Site.....	7-127
7.27	Challenges Associated with Using Rain Gardens in Coastal Georgia	7-128
7.28	Routine Maintenance Activities Typically Associated with Rain Gardens.....	7-132
7.29	Factors to Consider When Evaluating the Overall Feasibility of Using a Stormwater Planter on a Development Site	7-138
7.30	Challenges Associated with Using Stormwater Planters in Coastal Georgia	7-138
7.31	Routine Maintenance Activities Typically Associated with Stormwater Planters.....	7-142

7.32	Factors to Consider When Evaluating the Overall Feasibility of Using a Dry Well on a Development Site	7-145
7.33	Challenges Associated with Using Dry Wells in Coastal Georgia	7-146
7.34	Routine Maintenance Activities Typically Associated with Dry Wells	7-150
7.35	Factors to Consider When Evaluating the Overall Feasibility of Using a Rainwater Harvesting System on a Development Site.....	7-153
7.36	Routine Maintenance Activities Typically Associated with Rainwater Harvesting Systems	7-156
7.37	Factors to Consider When Evaluating the Overall Feasibility of Using a Bioretention Area on a Development Site.....	7-159
7.38	Challenges Associated with Using Bioretention Areas in Coastal Georgia	7-160
7.39	Factors to Consider When Evaluating the Overall Feasibility of Using an Infiltration Practice on a Development Site.....	7-166
7.40	Challenges Associated with Using Infiltration Practices in Coastal Georgia.....	7-167
7.41	Factors to Consider When Evaluating the Overall Feasibility of Using a Dry Swale on a Development Site	7-171
7.42	Challenges Associated with Using Dry Swales in Coastal Georgia	7-171

8.0 Stormwater Management Practices

8.1	How Stormwater Management Practices Can Be Used to Help Satisfy the Stormwater Management Criteria	8-10
8.2	Factors to Consider When Evaluating the Overall Feasibility of Stormwater Management Practices.....	8-15
8.3	Factors to Consider When Evaluating the Applicability of Stormwater Management Practices on a Development Site	8-18
8.4	Factors to Consider When Evaluating the Overall Feasibility of Using a Stormwater Pond on a Development Site	8-28
8.5	Challenges Associated with Using Stormwater Ponds in Coastal Georgia	8-29
8.6	Routine Maintenance Activities Typically Associated with Stormwater Ponds.....	8-32
8.7	Factors to Consider When Evaluating the Overall Feasibility of Using a Stormwater Wetland on a Development Site	8-42
8.8	Challenges Associated with Using Stormwater Wetlands in Coastal Georgia	8-43
8.9	Routine Maintenance Activities Typically Associated with Stormwater Wetlands.....	8-45
8.10	Factors to Consider When Evaluating the Overall Feasibility of Using a Bioretention Area on a Development Site.....	8-50
8.11	Challenges Associated with Using Bioretention Areas in Coastal Georgia	8-51
8.12	Routine Maintenance Activities Typically Associated with Bioretention Areas	8-56
8.13	Factors to Consider When Evaluating the Overall Feasibility of Using a Filtration Practice on a Development Site.....	8-64
8.14	Challenges Associated with Using Filtration Practices in Coastal Georgia	8-64
8.15	Routine Maintenance Activities Typically Associated with Filtration Practices.....	8-66
8.16	Factors to Consider When Evaluating the Overall Feasibility of Using an Infiltration Practice on a Development Site.....	8-73
8.17	Challenges Associated with Using Infiltration Practices in Coastal Georgia	8-74
8.18	Routine Maintenance Activities Typically Associated with Infiltration Practices	8-80
8.19	Factors to Consider When Evaluating the Overall Feasibility of Using a Swale on a Development Site	8-87
8.20	Challenges Associated with Using Swales in Coastal Georgia	8-89
8.21	Routine Maintenance Activities Typically Associated with Swales.....	8-91

9.0 Local Post-Construction Stormwater Management Programs

9.1 Example Action Items for Local Stormwater Management Programs.....9-8

9.2 Common Inconsistencies Between Existing Development Rules and the Approach to Stormwater Management Presented in this Coastal Stormwater Supplement9-13

List of Figures

1.0 Introduction

1.1	Natural Beauty of Coastal Georgia.....	1-1
1.2	Coastal Marshlands are One of Coastal Georgia's Most Valuable Natural Resources	1-1
1.3	Georgia's Coastal Nonpoint Source Management Area and Area of Special Interest	1-2
1.4	Manual for Erosion and Sediment Control in Georgia	1-3
1.5	Cypress Swamps Provide Valuable Habitat for Wood Storks	1-5
1.6	Alligators are One of the Many Creatures that Call Coastal Georgia Home.....	1-6

2.0 Coastal Natural Resources

2.1	Georgia's Coastal Nonpoint Source Management Area and Area of Special Interest	2-1
2.2	Altamaha River.....	2-1
2.3	Freshwater Marsh	2-2
2.4	Swamp	2-3
2.5	Okefenokee Swamp.....	2-3
2.6	Forested Depressional Wetland	2-3
2.7	Shipping on the Savannah River	2-4
2.8	Doboy Sound.....	2-5
2.9	Tidal Creek	2-5
2.10	Coastal Marshlands	2-5
2.11	Georgia's Coastal Marshlands.....	2-6
2.12	Tidal Flat.....	2-6
2.13	Scrub-Shrub Wetland.....	2-7
2.14	Sapelo Island and the Near Coastal Waters of the Atlantic Ocean.....	2-7
2.15	Beach on Jekyll Island	2-7
2.16	Floridan Aquifer System	2-8
2.17	Dunes on Cumberland Island.....	2-9
2.18	Maritime Forest	2-9
2.19	Marsh Hammock.....	2-10
2.20	Canebrake	2-10
2.21	Bottomland Hardwood Forest	2-11
2.22	Green-Fly Orchid.....	2-11
2.23	Flatwoods Salamander	2-12
2.24	Longleaf Pine-Wiregrass Savanna	2-12
2.25	Longleaf Pine.....	2-12
2.26	"Open" Shellfish Harvesting Area.....	2-13
2.27	Freshwater Stream and Adjacent Aquatic Buffer	2-13
2.28	Tidal Creek and Adjacent Floodplain	2-14

3.0 The Need for Natural Resource Protection and Stormwater Management

3.1	10-County Population Study Area	3-1
3.2	Clear and Level Building Site	3-2
3.3	Land Disturbing Activities Alter Site Hydrology	3-3
3.4	Changes in Site Hydrology Resulting from the Land Development Process	3-3
3.5	Pollutants that Accumulate on Impervious Surfaces are Transported Downstream During Storm Events	3-4
3.6	Bankfull Event.....	3-6

3.7	Overbank Flooding Event	3-6
3.8	Stream Channel Enlargement and Loss of Riparian Vegetation.....	3-7
3.9	Fish Kill of Atlantic Menhaden	3-7
3.10	Increased Ponding in a Freshwater Wetland	3-8
3.11	Excessive Sediment Accumulation in a Freshwater Wetland.....	3-8
3.12	Increased Productivity in a Freshwater Wetland	3-9
3.13	Trash and Debris Reduce the Aesthetic Value of Freshwater Wetlands.....	3-9
3.14	Increased Salinity Fluctuations Can Negatively Affect the Health of Shrimp and Other Aquatic Organisms	3-10
3.15	Algal Bloom.....	3-10
3.16	Shellfish Bed Contamination and Closure.....	3-11
3.17	Beach Contamination.....	3-12
3.18	Known Confined Groundwater Aquifer Recharge Areas	3-12
4.0	Stormwater Management and Site Planning and Design Criteria	
4.1	Green Infrastructure: An Interconnected Network of Undisturbed Natural Areas and Open Spaces	4-5
4.2	Bay Street Community Center, Savannah, GA.....	4-15
4.3	Multi-Zone Aquatic Buffer System	4-18
5.0	Calculating the Stormwater Runoff Volumes Associated with the Stormwater Management Criteria	
5.1	Bay Street Community Center, Savannah, GA.....	5-3
5.2	Average Velocities for Estimating Travel Time for Shallow Concentrated Flow.....	5-15
5.3	Approximate Geographic Boundaries for NRCS (SCS) Rainfall Distributions	5-18
5.4	Unit Peak Discharge for NRCS (SCS) Type II Rainfall Distribution	5-19
5.5	Unit Peak Discharge for NRCS (SCS) Type III Rainfall Distribution.....	5-20
5.6	Ratio of Uncontrolled Peak Discharge to Controlled Peak Discharge	5-22
5.7	Approximate Detention Basin Routing for NRCS (SCS) Type I, IA, III and III Rainfall Distributions	5-24
6.0	Satisfying the Stormwater Management and Site Planning and Design Criteria	
6.1	Site Planning and Design Process	6-1
6.2	Conventional Site Design.....	6-3
6.3	Conservation Site Design	6-3
6.4	New Urbanist Site Design.....	6-4
6.5	Integrating Natural Resource Protection and Stormwater Management with the Site Planning and Design Process	6-6
6.6	Conservation (Cluster) Development Versus Conventional Development	6-8
6.7	Buildable Area and Primary and Secondary Conservation Areas	6-9
6.8	Developing a Stormwater Management Concept Plan.....	6-11
6.9	Delineation of Primary and Secondary Conservation Areas.....	6-13
6.10	Stormwater Management Concept Plan that Incorporates a Variety of Better Site Planning and Design Techniques.....	6-18
6.11	Reforestation of a Disturbed Pervious Area	6-19
6.12	Green Roof Used in Place of a Traditional Impervious Rooftop.....	6-20
6.13	Rain Garden Used to "Receive" Stormwater Runoff.....	6-20
6.14	Stormwater Management Concept Plan that Incorporates a Variety of Low Impact Development Practices	6-27

6.15	Stormwater Pond	6-28
6.16	Stormwater Wetland.....	6-28
6.17	Bioretention Area	6-29
6.18	Infiltration Trench	6-29
6.19	Wet Swale	6-30
6.20	Dry Detention Basin Used to Provide Water Quantity Management	6-30
6.21	Stormwater Management Train	6-31

7.0 Green Infrastructure Practices

7.1	Reforestation of a Disturbed Pervious Area	7-3
7.2	Green Roof Used in Place of a Traditional Impervious Rooftop.....	7-3
7.3	Rain Garden Used to “Receive” Stormwater Runoff.....	7-3
7.4	Using Green Infrastructure Practices During the Creation of a Stormwater Management Concept Plan.....	7-5
7.5	Coastal Marshland are Considered to be a Primary Conservation Area	7-25
7.6	Primary and Secondary Conservation Areas Identified at the Beginning of the Site Planning and Design Process	7-26
7.7	Conservation Area in Midway, GA.....	7-29
7.8	Reduced Clearing and Grading Limits Used on a Development Site	7-35
7.9	Reduced Street Width Used on a Residential Development Site	7-39
7.10	Potential Design Options for Reduced Roadway Widths	7-40
7.11	Cul-de-Sac on a Residential Development Site.....	7-43
7.12	Alternative Cul-de-Sac Designs.....	7-44
7.13	Parking Lot on a Commercial Development Site	7-47
7.14	Structured Parking Deck on an Office Park Development Site.....	7-48
7.15	Permeable Pavers Used in a Parking Lot.....	7-49
7.16	Landscaping Island Located Within a Parking Lot	7-51
7.17	Shared Driveway on a Residential Development Site.....	7-53
7.18	Residential Development Site with Sidewalks on One Side of the Street	7-55
7.19	Reducing Building Footprints Can Help Reduce the Amount of Impervious Cover Created on Development Sites	7-57
7.20	Reduced Front Yard Setbacks Results in the Creation of Less Impervious Cover on Development Sites.....	7-59
7.21	Reduced Side Yard Setbacks and Narrower Frontages Used on Residential Development Sites.....	7-60
7.22	Alternative Lot Designs	7-60
7.23	Organic Compost	7-66
7.24	Active Replanting of Native Trees in a Disturbed Pervious Area.....	7-72
7.25	Components of a Green Roof System	7-78
7.26	Intensive Green Roof System	7-78
7.27	Extensive Green Roof System	7-79
7.28	Components of a Permeable Pavement System	7-86
7.29	Various Permeable Pavement Surfaces	7-87
7.30	Use of a Level Spreader Upstream of an Undisturbed Pervious Area	7-96
7.31	Filter Strip Around the Perimeter of a Parking Lot.....	7-102
7.32	Vegetated Filter Strip	7-103
7.33	Grass Channel Along a Local Roadway.....	7-110
7.34	Grass Channel	7-111
7.35	Simple Downspout Disconnections to Pervious Areas.....	7-118
7.36	Simple Downspout Disconnection	7-119
7.37	Various Rain Gardens	7-126

7.38	Various Stormwater Planters	7-136
7.39	Stormwater Planters	7-137
7.40	Dry Well.....	7-144
7.41	Rainwater Harvesting System	7-152
7.42	Major Components of a Rainwater Harvesting System	7-152
7.43	Various Bioretention Areas.....	7-158
7.44	Infiltration Trench	7-164
7.45	Infiltration Practices.....	7-165

8.0 Stormwater Management Practices

8.1	Stormwater Pond	8-2
8.2	Stormwater Wetland.....	8-2
8.3	Bioretention Area	8-3
8.4	Infiltration Trench	8-3
8.5	Wet Swale	8-4
8.6	Dry Detention Basin Used to Provide Water Quantity Management	8-4
8.7	Using Stormwater Management Practices During the Creation of a Stormwater Management Concept Plan.....	8-6
8.8	Stormwater Management Train	8-7
8.9	Various Stormwater Ponds	8-23
8.10	Schematic of a Typical Wet Pond	8-24
8.11	Schematic of a Typical Wet Extended Detention Pond	8-25
8.12	Schematic of a Typical Micropool Extended Detention Pond	8-26
8.13	Schematic of a Typical Multiple Pond System	8-27
8.14	Various Stormwater Wetlands	8-37
8.15	Schematic of a Typical Shallow Wetland	8-38
8.16	Schematic of a Typical Shallow Extended Detention Wetland	8-39
8.17	Schematic of a Typical Pond/Wetland System.....	8-40
8.18	Schematic of a Typical Pocket Wetland	8-41
8.19	Various Bioretention Areas.....	8-48
8.20	Schematic of a Typical Bioretention Area	8-49
8.21	Various Filtration Practices	8-60
8.22	Schematic of a Typical Surface Sand Filter	8-62
8.23	Schematic of a Typical Perimeter Sand Filter	8-63
8.24	Infiltration Trench	8-70
8.25	Infiltration Practices.....	8-71
8.26	Schematic of a Typical Infiltration Trench.....	8-72
8.27	Various Swales	8-84
8.28	Schematic of a Typical Dry Swale	8-85
8.29	Schematic of a Typical Wet Swale	8-86

9.0 Local Post-Construction Stormwater Management Programs

9.1	Post-Construction Stormwater Management Program Process Development Process.....	9-3
-----	--	-----

List of Text Boxes

4.0 Stormwater Management and Site Planning and Design Criteria

- 4.1 Green Infrastructure..... 4-5
- 4.2 Hydrologic Modeling of Pre-Development Conditions Using the Simple Method 4-15
- 4.3 Establishing an Aquatic Buffer 4-18

5.0 Calculating the Stormwater Runoff Volumes Associated with the Stormwater Management Criteria

- 5.1 Calculating the Runoff Reduction Volume 5-3

6.0 Satisfying the Stormwater Management and Site Planning and Design Criteria

- 6.1 Conservation Development 6-8
- 6.2 Example Plan Preparer Certification 6-38
- 6.3 Example Owner/Developer Certification 6-38

THIS PAGE INTENTIONALLY LEFT BLANK

1.0 Introduction

1.1 Background

Nearly two decades ago, the U.S. Congress recognized that land development and nonpoint source pollution were negatively impacting our nation's coastal waters (US EPA, 1993). These valuable aquatic resources provide habitat, food and shelter for many important aquatic and terrestrial organisms and contribute greatly to the natural beauty, economic well-being and quality of life found in our nation's coastal areas (Figure 1.1).



Figure 1.1: Natural Beauty of Coastal Georgia

(Source: Jeannie Lewis Rhodes, Georgia Department of Natural Resources)

Members of Congress recognized that a comprehensive effort was needed to control and minimize the negative impacts that land development and nonpoint source pollution were having on these important natural resources. Without one, they believed, these impacts, which include changes in hydrology, decreased water quality, due to increased levels of sediment, nutrients, metals, hydrocarbons, bacteria and other pollutants, increased water temperatures, reduced dissolved oxygen levels, degradation of habitat and an overall decline in wildlife abundance and diversity (US EPA, 2005), would be felt not only by the aquatic and terrestrial organisms that depend on them for survival, but by the general public as well.

With the passage of Section 6217 of the Coastal Zone Act Reauthorization Amendments of 1990 (CZARA), the U.S. Congress required states and territories with approved coastal management programs to develop comprehensive coastal nonpoint source pollution management programs. Shortly after Georgia's Coastal Management Program received approval from the National Oceanic and Atmospheric Administration (NOAA) in 1998, the Georgia Department of Natural Resources Environmental Protection Division (GA EPD), in conjunction with the Coastal Resources Division (CRD), began developing the state's Coastal Nonpoint Source (NPS) Management Program.



Figure 1.2: Coastal Marshlands are One of Coastal Georgia's Most Valuable Natural Resources

(Source: Jeannie Lewis Rhodes, Georgia Department of Natural Resources)

In 2002, the State's Coastal NPS Management Program was reviewed by the United States Environmental Protection Agency (US EPA) and NOAA and received conditional approval. In order to receive final approval, the state must provide for the implementation of several additional "management measures," which are intended to help balance land development and economic growth with the protection of coastal Georgia's valuable terrestrial and aquatic resources (Figure 1.2).

This Coastal Stormwater Supplement (CSS) represents the culmination of the state's efforts to provide for the implementation of the federally-established "management measures" related to

new development, watershed protection and site development (US EPA, 1993). Specifically, it provides guidance on using environmentally sensitive better site planning and design techniques, small-scale, low impact development practices and traditional stormwater management techniques (e.g., detention) to:

- Reduce the total suspended solids (TSS) loads contained in post-construction stormwater runoff by 80 percent, as measured on an average annual basis
- Maintain pre-development site hydrology
- Preserve areas that are particularly susceptible to erosion and sediment loss
- Preserve areas that provide important stormwater management benefits and/or provide valuable habitat for aquatic and terrestrial organisms
- Protect the integrity of streams, wetlands and other natural drainage features
- Limit land disturbing activities, such as clearing and grading and cutting and filling, to protect existing vegetation and reduce erosion and sediment loss
- Limit increases in site imperviousness

In providing for the implementation of these “management measures,” this CSS lays the foundation for an integrated, *green infrastructure*-based approach to natural resource protection, stormwater management and site design that can be used to protect coastal Georgia’s unique and vital natural resources from the negative impacts of the land development process.

Although the term *green infrastructure* can mean different things to different people, in its broadest and, perhaps, truest sense, the term refers to an interconnected network of undisturbed natural areas and open space that helps preserve the ecological function of our watersheds (Benedict and McMahon, 2006). This interconnected network of aquatic and terrestrial resources supports a wide range of important resident and migratory organisms, provides important stormwater management benefits and contributes greatly to coastal Georgia’s natural beauty, economic well-being and quality of life. Protecting this vital network of aquatic and terrestrial resources, which is the primary goal of this CSS, requires an integrated approach to natural resource protection and stormwater management.

1.2 Applicability of the Supplement

This CSS, like the state’s Coastal NPS Management Program, seeks to reduce the impacts of land development and nonpoint source pollution in a 24-county region located in southeast Georgia (Figure 1.3). Like the Georgia Stormwater Management Manual, it provides technical guidance that can be used to meet the post-construction stormwater management requirements of the National Pollution Discharge Elimination System (NPDES) permitting program. It

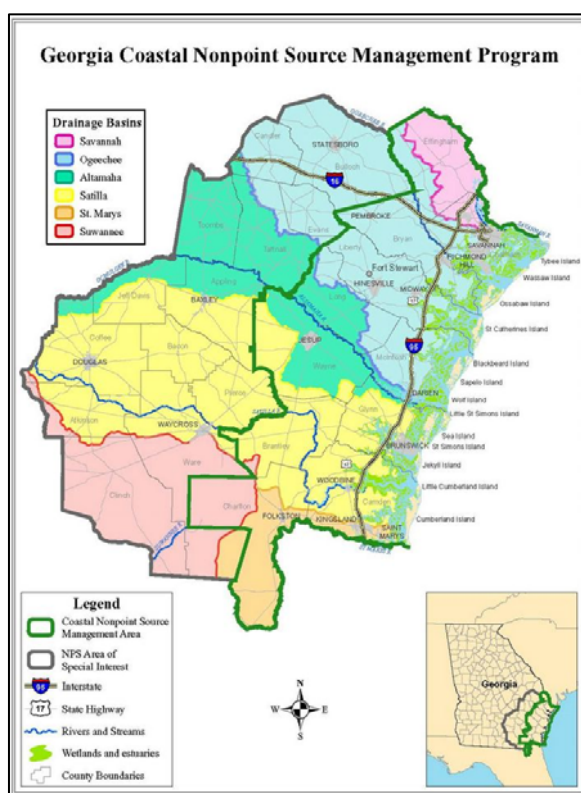

Figure 1.3: Georgia’s Coastal Nonpoint Source Management Area and Area of Special Interest

(Source: Georgia Department of Natural Resources)

also provides technical guidance for permit applicants seeking Coastal Marshlands Protection Act permits (O.C.G.A. §12-5-280 through §12-5-297, as amended).

For administrative purposes, the state's Coastal NPS Management Program has divided the 24-county coastal region into two distinct areas:

- Coastal Nonpoint Source Management Area: Georgia's Coastal Nonpoint Source Management Area is comprised of the first two tiers of counties that border the Atlantic Ocean. This 11-county area is also known as the *Coastal Management Program Service Area* and is synonymous with the area regulated by the *Georgia Coastal Management Act* (O.C.G.A. §12-5-320 through §12-5-329). Counties included within Georgia's Coastal Nonpoint Source Management Area include: Bryan, Brantley, Camden, Charlton, Chatham, Effingham, Glynn, Liberty, Long, McIntosh and Wayne.
- Coastal Nonpoint Source Area of Special Interest: Georgia's Coastal Nonpoint Source Area of Special Interest is made up of an additional 13 counties located immediately to the west of the Coastal Nonpoint Source Management Area. Counties included within the state's Coastal Nonpoint Source Area of Special Interest include: Appling, Atkinson, Bacon, Bulloch, Candler, Clinch, Coffee, Evans, Jeff Davis, Pierce, Tatnall, Toombs and Ware.

1.3 Purpose of the Supplement

The purpose of this CSS is to protect Georgia's existing water quality standards, particularly those of the state's coastal waters. It also provides for the implementation of the federally established "management measures" related to new development, watershed protection and site development in the Coastal Nonpoint Source Management Area and Area of Special Interest. To provide for the implementation of these "management measures," it provides comprehensive guidance on an integrated, green infrastructure-based approach to natural resource protection, stormwater management and site design that can be used by Georgia's coastal communities to better protect coastal Georgia's unique and vital natural resources from the negative impacts of land development and nonpoint source pollution.

It should be noted that this CSS does not provide guidance on managing *construction* stormwater runoff on development sites. While many of the better site planning and design techniques, low impact development practices and traditional stormwater management techniques discussed in this CSS can also be used to address *construction* stormwater runoff, more extensive guidance on the control of *construction* stormwater runoff can be found in the *Manual for Erosion and Sediment Control in Georgia* (GSWCC, 2000) (Figure 1.4).

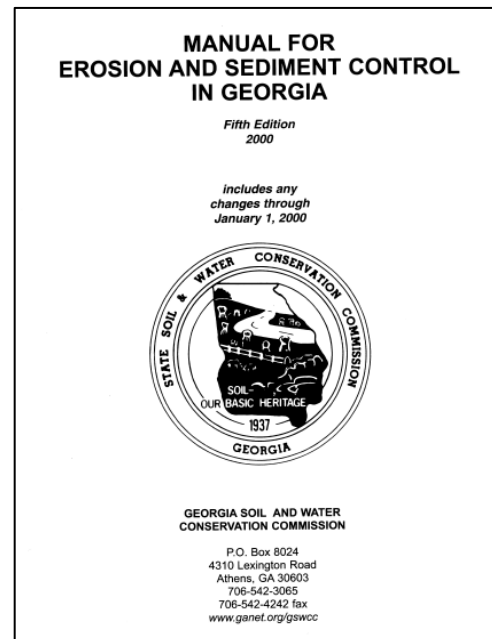

Figure 1.4: Manual for Erosion and Sediment Control in Georgia

(Source: Georgia Soil and Water Conservation Commission)

1.4 Organization of the Supplement

To enhance its utility and ease of use, this CSS has been divided into nine sections. Each section provides information that supports the implementation of an integrated, green infrastructure-based approach to natural resource protection, stormwater management and site design that can be used to protect coastal Georgia's valuable natural resources from the negative impacts of land development and nonpoint source pollution. The nine sections presented in this document include:

- Section 1.0: Section 1.0 provides an introduction to this CSS. It describes the purpose of the document and summarizes all of the information presented within.
- Section 2.0: Section 2.0 provides an introduction to some of the most valuable aquatic and terrestrial resources found in coastal Georgia. It describes the numerous functions and values that these important natural resources provide.
- Section 3.0: Section 3.0 describes the direct and indirect impacts that land development and nonpoint source pollution can have on the aquatic and terrestrial resources of coastal Georgia. It also outlines an integrated, green infrastructure-based approach to natural resource protection, stormwater management and site design that can be used to help control and minimize these impacts.
- Section 4.0: Section 4.0 presents a comprehensive set of post-construction stormwater management and site planning and design criteria that support an integrated approach to natural resource protection, stormwater management and site design. These criteria can be applied to new development and redevelopment activities occurring within the Coastal Nonpoint Source Management Area and Area of Special Interest.
- Section 5.0: Section 5.0 provides information on using accepted hydrologic methods to calculate the stormwater runoff volumes associated with the stormwater management criteria presented in this CSS. These calculations can be used to plan and design a post-construction stormwater management system that helps protect coastal Georgia's valuable natural resources from the negative impacts of land development and nonpoint source pollution.
- Section 6.0: Section 6.0 provides information about using the site planning and design process to satisfy the post-construction stormwater management and site planning and design criteria presented in this CSS. It provides detailed information about integrating natural resource protection and stormwater management with the site planning and design process.
- Section 7.0: Section 7.0 provides detailed information about the green infrastructure practices (e.g., better site planning and design techniques, low impact development practices) that can be used to meet the stormwater management and site planning and design criteria presented in this CSS. Each profile sheet provided in this Section describes a particular green infrastructure practice and includes information about its proper application, design, installation and maintenance.
- Section 8.0: Section 8.0 provides detailed information about the traditional stormwater management practices, such as wet ponds, wetlands and swales, that can be used to meet the stormwater management and site planning and design criteria presented in this CSS. Each profile sheet provided in this Section describes a particular stormwater

management practice and includes information about its proper application, design, installation and maintenance.

- **Section 9.0:** Section 9.0 provides information that can be used to develop a local post-construction stormwater management program that is consistent with the integrated, green infrastructure-based approach to natural resource protection, stormwater management and site design presented in this CSS. Georgia's coastal communities should find this Section of the document to be a valuable resource in their efforts to develop or enhance their own post-construction stormwater management programs.

1.5 Regulatory Status of the Supplement

This CSS has been designed to provide Georgia's coastal communities with comprehensive guidance on an integrated, green infrastructure-based approach to natural resource protection, stormwater management and site design that they can use to better protect the region's valuable natural resources from the negative impacts of land development and nonpoint source pollution. Although communities may choose to use the information presented in this CSS to regulate new development and redevelopment activities, the document itself has no independent regulatory authority. The integrated approach to natural resource protection, stormwater management and site design detailed in this CSS can only become required through:

- (1) Codes and ordinances established by local governments
- (2) Rules and regulations established by other local, state and federal agencies

It is *recommended* that all communities located within Georgia's 24-county coastal region, particularly those communities that are regulated by the NPDES Municipal Stormwater Program, use the information presented in this CSS, or an equivalent post-construction stormwater management manual, to regulate new development and redevelopment activities. Communities are encouraged to review and modify the contents of this CSS, as necessary, to meet local watershed and stormwater management goals and objectives.

1.6 Relationship of the Supplement to the Georgia Stormwater Management Manual

In 2001, the Atlanta Regional Commission (ARC), in conjunction with the Georgia Department of Natural Resources Environmental Protection Division (GA EPD) and 35 cities and counties from around the state of Georgia, published the *Georgia Stormwater Management Manual* (GSMM) (ARC, 2001). The GSMM outlines a comprehensive approach to post-construction stormwater management that has greatly improved the way that communities around the state address post-construction stormwater runoff.

Although the GSMM contains a wealth of valuable information about post-construction stormwater management, it does not provide all of the information needed to protect coastal Georgia's valuable natural resources from the negative impacts of land development and nonpoint source pollution. For example, the GSMM does not provide much information about



Figure 1.5: Cypress Swamps Provide Valuable Habitat for Wood Storks

(Source: Jeannie Lewis Rhodes, Georgia Department of Natural Resources)

the aquatic and terrestrial resources that can be found in coastal Georgia or about the negative impacts that land development and uncontrolled stormwater runoff can have on these critical natural resources (Figure 1.5). In addition, the GSMM does not provide *detailed* guidance on using green infrastructure practices (e.g., better site planning and design techniques, low impact development practices) or on adapting the design of traditional stormwater management practices, such as wet ponds and swales, to the site characteristics and constraints commonly encountered in coastal Georgia. To provide coastal Georgia with this valuable additional information, this CSS was developed. It builds on the wealth of information presented in the GSMM to promote an integrated, green infrastructure-based approach to natural resource protection, stormwater management and site design that can be used to better protect coastal Georgia's unique and vital natural resources from the negative impacts of land development and nonpoint source pollution.

The approach to natural resource protection and post-construction stormwater management that is currently used throughout most of coastal Georgia focuses primarily on *managing* stormwater quantity (and, in some cases, quality) and relies heavily on traditional stormwater management practices, such as wet and dry ponds, to *mitigate*, rather than *prevent*, the negative impacts of land development and nonpoint source pollution. The integrated approach to natural resource protection, stormwater management and site design presented in this CSS shifts the focus away from the *mitigation* of these impacts and instead places it on their *prevention*. To accomplish this, the CSS introduces the concept of *stormwater runoff reduction*, which effectively puts green infrastructure practices in the same "stormwater management toolbox" as traditional stormwater management practices, such as wet and dry ponds. The introduction of this *stormwater runoff reduction* concept marks an important milestone in the evolution of stormwater management in coastal Georgia. If successfully integrated into existing stormwater management efforts, it will lead to better protection of the aquatic and terrestrial resources that contribute so greatly to the region's natural beauty, economic well-being and quality of life.



Figure 1.6: Alligators are One of the Many Creatures that Call Coastal Georgia Home

(Source: Jeannie Lewis Rhodes, Georgia Department of Natural Resources)

The CSS is presented in a format that is similar to that of the GSMM. This allows readers that are already familiar with the GSMM to more efficiently use the information presented within. Although this CSS can be used as a stand-alone stormwater management manual, it does make a number of references to information presented in the GSMM. In case of a conflict between information presented in this CSS and the GSMM, the information contained in this CSS should be considered to be more protective of coastal Georgia's natural resources, habitats and wildlife (Figure 1.6).

1.7 How to Get Copies of the Supplement

Hard copies of this CSS can be ordered by calling the Georgia Department of Natural Resources Environmental Protection Division (GA EPD) Nonpoint Source Program at (404) 675-6240 or Coastal District at (912) 264-7284.

1.8 How to Find the Supplement on the Internet

Electronic copies of this CSS are available for free download from the following websites:

<http://www.gaepd.org>

<http://www.mpcnaturalresources.org>

<http://www.coastalgeorgiadc.org>

1.9 Contact Information

If you have any questions or comments about this CSS, please contact the Georgia Department of Natural Resources Division (GA EPD) Nonpoint Source Program at (404) 675-6240 or Coastal District at (912) 264-7284.

References

Atlanta Regional Commission (ARC). 2001. *Georgia Stormwater Management Manual*. Volume 2. Technical Handbook. Atlanta Regional Commission. Atlanta, GA. Available Online: <http://www.georgiastormwater.com/>.

Georgia Soil and Water Conservation Commission (GSWCC). 2000. *Manual for Erosion and Sediment Control in Georgia*. Georgia Soil and Water Conservation Commission. Athens, GA. Available Online: http://www.georgiaepd.org/Documents/esc_manual.html.

U.S. Environmental Protection Agency (US EPA). 2005. *National Management Measures to Control Nonpoint Source Pollution from Urban Areas*. EPA 841-B-05-004. U.S. Environmental Protection Agency. Office of Water. Washington, DC. Available Online: <http://www.epa.gov/nps/urbanmm/>.

U.S. Environmental Protection Agency (US EPA). 1993. *Guidance Specifying Management Measures for Sources of Nonpoint Pollution in Coastal Waters*. EPA 840-B-92-002. U.S. Environmental Protection Agency. Office of Wetlands, Oceans and Watersheds. Washington, DC. Available Online: <http://www.epa.gov/nps/MMGI/>.

2.0 Coastal Natural Resources

2.1 Overview

This Section of the Coastal Stormwater Supplement (CSS) provides an introduction to some of the most valuable natural resources found in coastal Georgia (Figure 2.1) and describes the numerous ecological functions and values that they provide. These natural resources, which include both aquatic and terrestrial resources, provide habitat, food and shelter for many important resident and migratory organisms and contribute greatly to the region's natural beauty, economic well-being and quality of life.

2.2 Aquatic Resources

An introduction to some of coastal Georgia's most valuable aquatic resources, which include freshwater, estuarine, marine and groundwater resources, is provided below.

2.2.1 Freshwater Resources

Freshwater aquatic resources can be found throughout Georgia's 24-county coastal region. An introduction to these aquatic resources, which include rivers and streams and freshwater wetlands, is provided below. Each of these resources provides habitat for high priority plant and animal species (Appendix A) and are considered to be high priority habitat areas (WRD, 2005).

2.2.1.1 Rivers and Streams



Figure 2.2: Altamaha River
(Source: Georgia Department of Economic Development)

Freshwater rivers and streams drain water from the landscape as they meander from areas of higher elevation to the Atlantic Ocean. These rivers and streams, which include the Altamaha River (Figure 2.2), Ogeechee River, Satilla River, Savannah River and St. Mary's River, as well as many other smaller rivers, streams and creeks, known as tributaries, provide habitat for a diverse group of aquatic and terrestrial organisms. While fish, insects and other aquatic organisms can be found living within the rivers and streams themselves, birds, mammals and other terrestrial organisms find food and shelter in the vegetation that grows in the floodplain swamps (Section 2.2.1.2) and bottomland hardwood forests

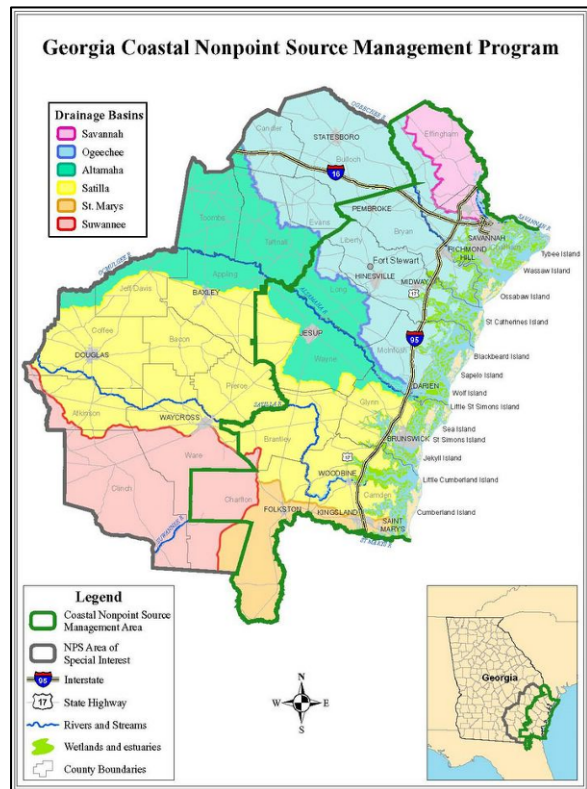

Figure 2.1: Georgia's Coastal Nonpoint Source Management Area and Area of Special Interest

(Source: Georgia Department of Natural Resources)

(Section 2.3.5) that can be found adjacent to these valuable aquatic resources. Freshwater rivers and streams also provide numerous recreational opportunities, such as boating, fishing and bird watching, and, in some situations, can be used as a water supply.

2.2.1.2 Freshwater Wetlands

Georgia's 24-county coastal region is rich in freshwater wetlands, which are areas that have hydric soils, support the growth of wetland vegetation and are either temporarily or permanently inundated or saturated by surface or groundwater (US ACOE, 1987). Freshwater wetlands, which include marshes, swamps and bogs, and are described in more detail below, provide many important ecological services and functions, including pollutant removal, flood attenuation, erosion control, groundwater recharge and wildlife habitat (Wright et al., 2006). While it is difficult to put a monetary value on these otherwise "free" ecological services, recent wetland valuation studies have estimated that freshwater wetlands and the services they provide may be worth as much as \$370,000 per acre (Heimlich et al., 1998).

Although coastal Georgia is best known for its coastal marshlands (Section 2.2.2.4), its freshwater wetlands are an extremely important natural resource. Freshwater wetlands provide a number of recreational opportunities, including hunting, fishing, canoeing and bird watching, which can generate income for communities located near or adjacent to these important aquatic resources. In fact, in 2006, Americans spent more than \$122 billion on the outdoor activities, such as hunting, fishing and bird watching, that typically occur in and around freshwater wetlands (USFWS and USCB, 2008). In Georgia alone, residents and tourists spent more than \$3.5 billion on these activities (USFWS and USCB, 2008). Freshwater wetlands also support a wide range of threatened and endangered species, and even the smallest of freshwater wetlands can support fragile amphibian populations, which are threatened globally (Houlahan et al., 2000). Because of their value and particular sensitivity to the direct impacts of the land development process (Section 3.2), high priority should be given to protecting coastal Georgia's freshwater wetlands.

Marshes

Freshwater marshes (Figure 2.3) can be found throughout coastal Georgia, particularly along freshwater rivers and streams, in poorly drained depressions, in the shallow waters located around the edges of lakes, ponds and coastal marshlands and interspersed with sand dunes on the barrier islands. They are typically dominated by emergent wetland vegetation, including cutgrass, sawgrass, pickerel weed, wild rice and other grasses, sedges, rushes and reeds. They provide habitat for a wide variety of animals, including fish, mink, otter and alligator, and are a popular roosting and nesting place for many birds. In addition to their considerable habitat value, freshwater marshes serve many important ecological functions, including pollutant removal, flood attenuation, erosion control and groundwater recharge (Wright et al., 2006).



Figure 2.3: Freshwater Marsh
(Source: Center for Watershed Protection)

Swamps

Swamps (Figure 2.4) are freshwater wetlands that are dominated by trees and other woody vegetation. They can be found throughout Georgia's 24-county coastal region, especially along the freshwater rivers, streams and creeks that meander through the landscape. They have saturated, highly organic soils, which support the growth of water tolerant trees, such as bald cypress, tupelo gum, swamp privet, water elm and swamp dogwood. While non-alluvial (i.e., blackwater) swamps are typically nutrient-poor, alluvial (i.e., brownwater) swamps are subject to overbank sediment deposition, which typically makes them more productive. Both alluvial and non-alluvial swamps provide downstream flood protection, help improve water quality by removing excess nutrients from stormwater runoff and provide food and shelter to a wide variety of aquatic and terrestrial organisms (Wright et al., 2006).



Figure 2.4: Swamp
(Source: Center for Watershed Protection)

Coastal Georgia also happens to be home to one of the largest swamps in North America, the Okefenokee Swamp (Figure 2.5). A wide variety of wildlife can be found within the swamp, including more than 200 varieties of birds, more than 60 kinds of reptiles and a number of different mammals, amphibians and fish (GHC and UGP, 2008a).



Figure 2.5: Okefenokee Swamp
(Source: Georgia Department of Economic Development)

Bogs

Bogs, also known as forested depressional wetlands, bayheads or shrub bogs, are forested wetlands that can be found scattered throughout coastal Georgia. They are typically found in poorly-drained areas and have saturated, nutrient poor soils that are comprised of a mixture of organic peat and sand. Forested depressional wetlands (Figure 2.6) are typically dominated by broad-leaved evergreen trees and shrubs, including sweetbay (magnolia), loblolly bay, white cedar, pond pine, slash pine and swamp titi, and receive all or most of their water from precipitation, rather than from stormwater runoff, groundwater or streamflow. They provide valuable habitat for a variety of plants and animals, including a number of threatened and endangered species, such as the flatwoods salamander, and help reduce flooding by retaining precipitation that would otherwise be converted to stormwater runoff.



Figure 2.6: Forested Depressional Wetland
(Source: Duke University Wetland Center)

2.2.2 Estuarine Resources

Estuaries are large, semi-enclosed bodies of water where water from freshwater rivers and streams meets and mixes with saltwater from the ocean. Estuaries are transitional areas between land and sea and are among the most productive ecosystems on earth. They provide critical habitat and nursery areas for a diverse community of aquatic organisms including sea and shore birds, fish, crabs, marine mammals, clams, mussels, marine worms and reptiles. In addition to having significant ecological value, estuaries are inexorably linked to the economic well-being of coastal Georgia and the rest of the state. Approximately 75 percent of the commercial fish species caught in the United States use the estuarine environment as habitat during at least one stage of their life (Morton, 1997). These commercial fish species, together with their recreational counterparts, support a national fishing industry that is worth an estimated \$12 billion (US EPA, 1993).

An introduction to Georgia's estuarine resources, which include tidal rivers, sounds, tidal creeks, coastal marshlands and tidal flats, is provided below. Each of these resources provides habitat for high priority plant and animal species (Appendix A) and are considered to be high priority habitat areas (WRD, 2005).

2.2.2.1 Tidal Rivers

A tidal river is a river or stream or, more commonly, a segment of a river or stream, that is influenced by the Atlantic Ocean. In coastal Georgia, the influence of the Atlantic Ocean extends nearly 60 miles inland and creates a tidal range of between 6 and 9 feet (CRD, 2007). This unusually large tidal range, and the associated tidal water volumes, velocities and turbidities, prevents submerged aquatic vegetation from growing in coastal Georgia's tidal rivers and streams. It is worth noting that submerged aquatic vegetation can be found growing in the tidal rivers of most of the other Eastern, Southeastern and Gulf states.



Figure 2.7: Shipping on the Savannah River
(Source: Georgia Department of Economic Development)

Georgia's major tidal rivers, which include the lower reaches of the Altamaha, Ogeechee, Satilla, Savannah and St. Mary's Rivers, as well as other smaller tidal rivers and streams, provide the freshwater that meets and mixes with saltwater from the Atlantic Ocean to create the estuarine environment. Although not all of Georgia's tidal rivers and streams are estuarine, those that are provide habitat for a variety of aquatic organisms, including fish, dolphins, manatees, whales, alligators, turtles, plankton, nematodes and marine worms. They also provide a number of recreational opportunities, including fishing and boating, and, in some situations, are used as commercial shipping routes (Figure 2.7).

2.2.2.2 Sounds

The tidal rivers of coastal Georgia connect with the Atlantic Ocean in large, open bodies of water known as sounds. The sounds of coastal Georgia, which include, from north to south, Wassaw Sound, Ossabaw Sound, St. Catherine's Sound, Sapelo Sound, Doboy Sound (Figure 2.8), Altamaha Sound, Buttermilk Sound, St. Simon's Sound, Jekyll Sound, St. Andrew Sound and Cumberland Sound, are found in between the coastal barrier islands and the coastal mainland.

Although the sounds are greatly influenced by the tides, many of them are protected from the full force of ocean waves, winds and storms by the barrier islands. These sheltered waters provide habitat for a diverse group of aquatic organisms including fish, turtles, dolphins, manatees, whales, shrimp and blue crabs. They also provide a number of recreational opportunities for tourists as well as residents of Georgia's 24-county coastal area.

2.2.2.3 Tidal Creeks

Tidal creeks are the small, tidally-influenced waterways that can be found meandering through the marshlands and barrier islands of coastal Georgia. These tidal creeks, which can be found along the entire length of the Georgia coast, typically begin in upland areas and work their way through the landscape (Figure 2.9) until they join another tidal creek, larger tidal river or sound. As an estuarine resource, they provide critical habitat and food for many aquatic organisms, acting as primary nursery areas for fish, shrimp, crabs and sea and shore birds. Red drum, spotted sea trout, spot, croaker, white and brown shrimp and blue crabs are just some of the economically important fish and shellfish species that spend at least some of their time in tidal creeks (Holland and Sanger, 2008). The productivity and accessibility of these tidal creeks makes them a very popular place for both commercial and recreational fishing and shellfishing.



Figure 2.8: Doboy Sound

(Source: National Oceanic and Atmospheric Administration)



Figure 2.9: Tidal Creek

(Source: Georgia Department of Natural Resources)

2.2.2.4 Coastal Marshlands



Figure 2.10: Coastal Marshlands

(Source: Center for Watershed Protection)

Almost a third of the remaining vegetated coastal marshlands found along our nation's Atlantic coastline can be found in coastal Georgia (GHC and UGP, 2008b). These expansive, low-lying, tidally influenced wetlands (Figure 2.10) can be found along the entire length of the Georgia coast, in a four to six mile wide band between the coastal barrier islands and the coastal mainland. Dominated by vast expanses of emergent salt marsh vegetation, particularly smooth cordgrass (*Spartina alterniflora*), saltmeadow cordgrass (*Spartina patens*) and black needlerush (*Juncus roemerianus*), the coastal marshlands are perhaps coastal Georgia's most visible and

valuable natural resource. They provide vital food and habitat for many terrestrial and aquatic organisms, acting as nesting sites for several species of sea and shore birds, and as nursery areas

for many important species of fish and shellfish, including red drum, spotted sea trout, spot, croaker, white and brown shrimp and blue crabs (Holland and Sanger, 2008). These and other economically important fish and shellfish species that can be found in the coastal marshlands contribute an estimated \$5 billion to the value of the national fishing and shellfishing industries (US EPA, 1993). Coastal marshlands also provide a buffer against flooding and erosion, help control and reduce pollution and provide a natural beauty that enhances property values and the quality of life in Georgia's 24-county coastal region.



Figure 2.11: Georgia's Coastal Marshlands

(Source: Sapelo Island National Estuarine Research Reserve)

Georgia's coastal marshlands, as legally defined, include all of the salt marshes, intertidal areas, tidal flats and tidal water bottoms that are found within the state's legally defined estuarine area. The coastal marshlands are considered a public resource and, in all but a few cases, are owned and managed by the state, in trust, for both current and future generations. Portions of the coastal marshlands that are not owned by the state include areas that have been granted, through unbroken chain of title, to private land owners by the King of England or the State of Georgia. Even when the public does not own them, the function and value of all of Georgia's coastal marshlands (Figure 2.11) are protected by the state's *Coastal Marshlands Protection Act*

(O.C.G.A. §12-5-280 through §12-5-297). According to the *Act*, activities within the coastal marshlands that are typically considered contrary to the public interest include the placement of fill for residential or commercial purposes, the placement of dredge spoils and the construction of private roadways.

2.2.2.5 Tidal Flats

Tidal flats (Figure 2.12), including both mud and sand flats, can be found within the coastal marshlands in areas where emergent salt marsh vegetation cannot grow. They are often formed in areas where fine sediments or sands have been deposited by tidal rivers, tidal creeks or the tides themselves, and prevent the growth of emergent salt marsh vegetation. Despite the absence of vegetation, tidal flats are often recognized for their high productivity and abundant wildlife populations. Large populations of plankton, snails, oysters, clams and worms are often found within tidal flats and many species of fish and sea and shore birds, including plovers, sandpipers and dowitchers, migrate into them with the tides to feed. Since they provide habitat for many species of shellfish, they are also popular place for both commercial and recreational shellfishing.



Figure 2.12: Tidal Flat

(Source: Hugh and Carol Nourse)

2.2.2.6 Scrub-Shrub Wetlands

Scrub-shrub wetlands (Figure 2.13) can be found along the Georgia coast, near the shoreward reaches of the coastal marshlands. Although they are typically dominated by groundsel tree, marsh elder, yaupon holly, wax myrtle, Florida privet and false willow, they may also contain wind-pruned red cedar. These unique estuarine wetlands, which are infrequently flooded by tidal action, provide habitat for a variety of aquatic and terrestrial organisms and often form an ecotone between the estuarine and terrestrial environments.



Figure 2.13: Scrub-Shrub Wetland
(Source: National Oceanic and Atmospheric Administration)

2.2.3 Marine Resources

The marine environment extends from the seaward edge of the estuarine environment to the outer edge of the continental shelf. Unlike the estuarine environment, it is completely exposed to the full force of ocean waves, winds and storms and, except in areas immediately adjacent to the mouths of large rivers and streams, is not influenced by freshwater to any great extent. Although not as biologically productive as the estuarine environment, the marine environment does have a level of productivity that is higher than that of the open ocean and provides habitat for a number of aquatic and terrestrial organisms. An introduction to the marine resources of coastal Georgia, which include near coastal waters and beaches, is provided below.



Figure 2.14: Sapelo Island and the Near Coastal Waters of the Atlantic Ocean
(Source: Georgia Department of Economic Development)

2.2.3.1 Near Coastal Waters

The near coastal waters of the Atlantic Ocean (Figure 2.14) provide habitat for a number of fish, turtles and marine mammals, including bottlenose dolphins, manatees, North Atlantic right whales and loggerhead, green and leatherback turtles. They also provide habitat for many commercially important species of fish and shellfish, including penaid shrimp, blue crab, star drum, spot and croaker. As a result, they are a popular place for both commercial and recreational fishing.



Figure 2.15: Beach on Jekyll Island
(Source: Georgia Department of Economic Development)

2.2.3.2 Beaches

The estuarine environment meets the marine environment along the sandy beaches of the coastal barrier islands, which can be found along the entire length of the Georgia coast between the open ocean and the coastal mainland.

Georgia's barrier islands include, from north to south, Tybee Island, Little Tybee Island, Wassaw Island, Ossabaw Island, St. Catherine's Island, Blackbeard Island, Sapelo Island, Wolf Island, Little St. Simon's Island, St. Simon's Island, Sea Island, Jekyll Island, which is a State Park, and Cumberland Island, which is the largest barrier island in the United States. Stretches of sandy beach (Figure 2.15) along these barrier islands provide numerous recreational opportunities, such as boating, fishing, swimming, walking, beachcombing, bird-watching and sunbathing. Due to the recreational opportunities they provide, a number of them have become popular tourist destinations and, as a result, valuable economic resources (e.g., Tybee Island, Jekyll Island). Beaches also provide habitat for a variety of plants and animals, including turtles, soft-shelled clams, crabs and worms. Sea and shore birds feed extensively on beaches and over 75 percent of migratory waterfowl live on or depend on beaches for food or shelter during at least one stage of their lives (US EPA, 1998).

2.2.4 Groundwater Resources

Groundwater resources can be found throughout Georgia's 24-county coastal region. An introduction to these aquatic resources, which include groundwater aquifers, is provided below.

2.2.4.1 Groundwater Aquifers

Since the 1880s, groundwater aquifers have served as the principal source of water for coastal Georgia. Much of this water comes from the Upper Floridan aquifer, which is an extremely permeable and high-yielding confined aquifer system that underlies an area of about 100,000 square miles beneath southeast Georgia, southwest South Carolina, southeast Alabama and Florida (Figure 2.16) (Priest, 2004). Because of the amount of groundwater that it yields, the Floridan aquifer system is often recognized as one of the most productive aquifers in the world.

The distance between the surface and the top of the Floridan aquifer ranges from less than 150 feet in coastal South Carolina to more than 1,400 feet in southeastern Georgia (i.e., Glynn and Camden Counties). Between the surface and the top of the Floridan aquifer system lies the confined Brunswick aquifer system and the unconfined shallow surficial aquifer system. Although the shallow surficial aquifer system does not supply much potable water in coastal Georgia, it does help maintain valuable baseflow within the region's rivers, streams and other aquatic resources.



Figure 2.16: Floridan Aquifer System
(Source: U.S. Geological Survey)

2.3 Terrestrial Resources

An introduction to some of coastal Georgia's most valuable terrestrial resources, which include dunes, maritime forests, marsh hammocks, evergreen hammocks, canebrakes, bottomland hardwood forests, beech-magnolia forests, pine flatwoods, longleaf pine-wiregrass savannas and longleaf pine-scrub oak woodlands, is provided below. While some of these resources are transitional areas between water and land (e.g., canebrakes, bottomland hardwood forests),

each provides habitat for high priority plant and animal species (Appendix A) and are all considered to be high priority habitat areas (WRD, 2005).

2.3.1 Dunes

Dunes are found just inland of the beaches on the coastal barrier islands. They form ridgelines on the ocean side of the barrier islands, which provide effective protection to the estuarine environment and coastal mainland against the damaging effects of floods, winds, tides and erosion. Along with beaches, sand bars and shoals, they are part of Georgia's sand sharing system and are protected by the state's *Shore Protection Act* (O.C.G.A. §12-5-230 through §12-5-248).



Figure 2.17: Dunes on Cumberland Island
(Source: Georgia Department of Economic Development)

Dunes (Figure 2.17), and their associated ridges, flats and swales, also provide habitat for a number of important plants and animals, including several rare and endangered species. For example, high densities of eastern diamondback rattlesnakes can be found in inter-dune flats and swales that are densely vegetated with bunch grasses and other herbaceous vegetation. These areas provide ideal habitat for this important species, and are abundant on a number of the state's barrier islands, including Little St. Simon's Island and Blackbeard Island (Means, Personal Communication). On Cumberland Island, nearly 10,000 acres of land, which provides valuable habitat not only for the eastern diamondback rattlesnake but also for other important aquatic and terrestrial organisms, are protected as part of the National Wilderness Preservation System (Wilderness Institute, 2008).

2.3.2 Maritime Forests



Figure 2.18: Maritime Forest
(Source: Smithsonian Marine Station)

The largest remaining stands of maritime forest that are found along our nation's Atlantic coastline can be found in coastal Georgia (Ambrose, Personal Communication). These maritime forests can be found covering the more stable portions of the sandy ridges, flats and swales of the coastal barrier islands. They are typically dominated by live oak, palmetto and other broad-leaved evergreen trees and shrubs (Figure 2.18). The organisms that live within a maritime forest are particularly well adapted to the unique characteristics (e.g., limited freshwater availability, periodic seawater inundation, wind damage, dune migration) of these valuable, but endangered terrestrial resources. Maritime forests

help maintain valuable groundwater recharge, help stabilize soils and provide important habitat for wading birds, including the federally endangered wood stork, neotropical migratory birds, diamondback terrapins and other wildlife.

2.3.3 Marsh Hammocks

Marsh hammocks (Figure 2.19), also known as back barrier islands, are small islands of upland habitat located within the coastal marshlands. Ranging from less than an acre to more than 1,000 acres in size, they are the only dry land that can be found within the coastal marshlands. Over the years, the state's Coastal Marshlands Protection Committee, which was created by the *Coastal Marshlands Protection Act* (O.C.G.A. §12-5-280 through §12-5-297), has received numerous applications from land owners and developers who would like to build bridges to these back barrier islands in order to develop them. Historically, the Committee has granted many of these permit applications. Recently, however, the number of permit applications has increased. As a result, many coastal Georgians have become concerned that the continued development of these hammocks, which support the growth of maritime forests (Section 2.3.2) and provide habitat for migrant neotropical birds and a variety of other plants and animals, including a number of important rare, threatened and endangered species, such as the wood stork, painted bunting, silver buckthorn and Florida privet, will have a negative impact on the ecology and overall environmental health of the region.



Figure 2.19: Marsh Hammock
(Source: Coastal Georgia Research Council)

2.3.4 Evergreen Hammocks

Evergreen hammocks are small, isolated areas of upland habitat typically found within alluvial (i.e., brownwater) floodplains and freshwater depressional wetlands (Section 2.2.1.2). Evergreen hammocks provide habitat for a variety of trees and other woody vegetation, including sub-mesic oak and hickory species, as well as southern magnolia, American holly, ironwood, flowering dogwood and spruce pine. Because of their topographic setting and tendency to retain moisture, they provide relatively fire-resistant habitat for a variety of terrestrial organisms.

2.3.5 Canebrakes

Canebrakes (Figure 2.20) can be found throughout coastal Georgia, particularly along the freshwater rivers, streams and creeks that can be found meandering through the landscape. These dense thickets of native river cane (*Arundinaria gigantea*) provide important habitat for a variety insects and migratory neotropical birds, including the Swainson's Warbler. Canebrakes are fire-dependent, meaning that they require periodic burning or other forms of disturbance to prevent them from becoming overgrown by larger, woody shrubs and hardwood tree species.



Figure 2.20: Canebrake
(Source: J. Michael Myers, U.S. Geological Survey)

2.3.6 Bottomland Hardwood Forests

Bottomland hardwood forests (Figure 2.21) can be found on the natural levees and floodplains surrounding coastal Georgia's freshwater rivers and streams. Bottomland hardwood forests that are found on the lower levels of these floodplains are frequently flooded, and are typically classified as swamps or freshwater wetlands (Section 2.2.1.2), while bottomland hardwood forests that are found on the upper levels of these floodplains are typically dry and are rarely inundated. Consequently, bottomland hardwood forests are transitional areas between water and land, and include areas that are considered to be jurisdictional wetlands, as well as those that are not.



Figure 2.21: Bottomland Hardwood Forest
(Source: S.J. Baskauf)

Bottomland hardwood forests contain a wide variety of species but are typically dominated by mesic (i.e., moist) and hydric (i.e., wet) species such as oak, green ash, sweetgum, red maple and water hickory. These diverse and expansive forest communities provide valuable habitat for a wide variety of organisms, and are especially important to those species adapted to life within the dark interior of these and other hardwood forest communities.

2.3.7 Beech-Magnolia Forests

Beech-magnolia forests are relatively rare hardwood forest communities that are often found near hillside seeps, which provide groundwater input for freshwater wetlands, on the bluffs and gentle slopes surrounding coastal Georgia's freshwater rivers and streams. Due to their unique topographic setting and ability to retain moisture, beech-magnolia forests tend to have a unique ability to resist fire. This is perhaps the biggest difference between beech-magnolia forests and their adjacent upland counterparts. In addition to American beech and southern magnolia, beech-magnolia forests may contain water oak, water hickory, American holly and other fire-tolerant hardwood species. Threatened and endangered species, such as the green-fly orchid (Figure 2.22), may also be found in these unique hardwood forests.



Figure 2.22: Green-Fly Orchid
(Source: David R. McAdoo)

2.3.8 Pine Flatwoods

Pine flatwoods are mesic (i.e., moist) or hydric (i.e., wet) forests that can be found covering the flat, poorly-drained areas of the 24-county coastal region. While most of the "wetter" pine flatwoods are considered to be jurisdictional wetlands, some of the better-drained pine flatwoods are not. While the "wetness" of a pine flatwood varies according to local topography and seasonal rainfall, the soils found within these forest communities typically stay saturated for much of the year. In particularly low-lying areas, water may be visible on the surface of a pine

flatwood year round; at higher elevations, little or no surface water may be visible throughout the year.

Historically, pine flatwoods were dominated by longleaf pine; now they are typically dominated by slash pine, loblolly pine or pond pine. Although they are dominated by these pine species, pine flatwoods also contain palmetto, wax myrtle, gallberry, lowbush blueberry and other woody shrub species. These expansive and diverse forest communities provide valuable habitat for a wide variety of terrestrial organisms, including a number of threatened and endangered species, such as the flatwoods salamander (Figure 2.23), which appears on both the state and federal protected species lists.

2.3.9 Longleaf Pine-Wiregrass Savannas

Longleaf pine-wiregrass savannas (Figure 2.24) are characterized by their sparse canopy, which consists primarily of longleaf (Figure 2.25) or slash pine, and well-developed understory, which is typically dominated by wiregrass and other grasses and herbs. Longleaf pine-wiregrass savannas can be either mesic (i.e., moist) or xeric (i.e., dry), or somewhere in between, depending on local topography and soil types. Pine flatwoods (Section 2.3.8) and freshwater depressional wetlands (Section 2.2.1.2), are often



Figure 2.25: Longleaf Pine
(Source: W. Cook)

found within the low-lying areas located in and adjacent to these unique forest communities.

Longleaf pine-wiregrass savannas are fire-dependent, meaning that they require regular burning to prevent them from becoming overgrown by larger, woody shrubs and hardwood tree species. If fire is suppressed within a longleaf pine-wiregrass savanna for a long period of time, less fire-tolerant woody tree and shrub species will begin to move in, which dramatically reduces overall biological diversity.

Today, more than 30 threatened and endangered plant and animal species, including the Eastern Indigo snake, red-cockaded woodpecker, flatwoods salamander, hairy rattleweed and gopher tortoise, can be found living within these longleaf pine-wiregrass savannas. In addition to these threatened and endangered species, a number of other important organisms are known to inhabit these valuable terrestrial resources, including more than 1,200 species of vascular plants and 225 species of birds, mammals, reptiles and amphibians.



Figure 2.23: Flatwoods Salamander
(Source: Fort Stewart)



Figure 2.24: Longleaf Pine-Wiregrass Savanna
(Source: M. Aresco)

2.3.10 Longleaf Pine-Scrub Oak Woodlands

Longleaf pine-scrub oak woodlands are characterized by their sparse canopy, which consists primarily of longleaf pine (Figure 2.25), and patchy oak understory, which is comprised primarily of turkey oak, sand post oak, bluejack oak, blackjack oak and other scrub oak species. These unique forest communities are typically found on ridges and bluffs with deep, sandy soils and on the upper reaches of the gentle slopes surrounding coastal Georgia's freshwater rivers and streams. Longleaf pine-scrub oak woodlands typically have a fairly diverse groundcover layer consisting of grasses, forbs and scrubs that are able to survive on a very limited water supply.

2.4 Other Resources

An introduction to some of coastal Georgia's other important natural resources, which include shellfish harvesting areas, aquatic buffers and floodplains, is provided below. It is important to note that, unlike the aquatic and terrestrial resources described earlier in this Section, the natural resources described below do not represent discrete habitat areas or geographical units. Instead, they represent areas where one or more aquatic and/or terrestrial resources combine to provide special ecosystem services that contribute greatly to coastal Georgia's natural beauty, economic well-being and quality of life.

2.4.1 Shellfish Harvesting Areas

Coastal Georgia's sounds, coastal marshlands, tidal flats and other estuarine resources provide food and habitat for many important species of shellfish, including oysters and clams. Although the productivity and accessibility of these estuarine resources makes them a popular place for both commercial and recreational shellfishing, state law (O.C.G.A. §27-4-190 through §27-4-201) prohibits shellfish from being taken anywhere outside of "open" shellfish harvesting areas (Figure 2.26). All other areas are considered to be "closed" to shellfish harvesting, which makes the shellfish harvesting areas that are open to commercial and recreational shellfishing even more important to the economy of the 24-county coastal region and that of the entire state.

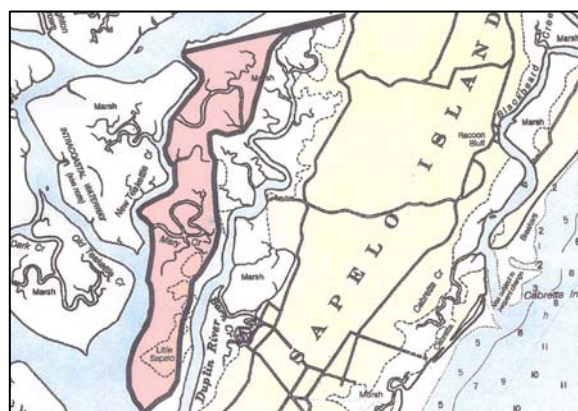

Figure 2.26: "Open" Shellfish Harvesting Area

(Source: Georgia Department of Natural Resources)



Figure 2.27: Freshwater Stream and Adjacent Aquatic Buffer

(Source: Merrill et al., 2006)

2.4.2 Aquatic Buffers

Aquatic buffers (Figure 2.27) are undisturbed natural areas that can be found immediately adjacent to coastal Georgia's rivers and streams, tidal creeks, coastal marshlands and other aquatic resources. Although aquatic buffers function primarily to preserve the integrity of streams, wetlands and other aquatic resources and protect them from the direct impacts of the land development process, they also provide a number of other important ecological services and functions, including pollutant removal, erosion control and conveyance and temporary

storage of flood flows. In an undisturbed state, aquatic buffers create an ecotone between the aquatic and terrestrial environments, and provide important habitat for both aquatic and terrestrial organisms.

2.4.3 Floodplains

Floodplains (Figure 2.28) are flat or relatively flat areas that can be found adjacent to coastal Georgia's rivers and streams, tidal creeks, coastal marshlands and other aquatic resources. They are defined by topography, hydrology and stream geomorphology. When a river, stream or other aquatic resource overtops its banks, its floodplain provides conveyance and temporary storage of the resulting flood flows. In an undisturbed state, floodplains help attenuate these damaging flood flows by conveying them through the dense vegetation that can be found growing within the freshwater wetlands (Section 2.2.1.2), scrub-shrub wetlands (Section 2.2.2.6), bottomland hardwood forests (Section 2.3.6) and other vegetative communities that are associated with them. Although floodplains function primarily to provide flood control, they also provide a number of other important ecological services and functions, including pollutant removal, erosion control, groundwater recharge and wildlife habitat.



Figure 2.28: Tidal Creek and Adjacent Floodplain

(Source: Center for Watershed Protection)

2.5 Summary

As documented above, a variety of valuable aquatic and terrestrial resources can be found within Georgia's 24-county coastal region. These natural resources provide habitat, food and shelter for many important aquatic and terrestrial organisms and contribute greatly to the region's natural beauty, economic well-being and quality of life. The next section of the CSS describes the direct and indirect impacts that the land development process can have on these natural resources and why an integrated approach to natural resource protection, stormwater management and site design is needed to help control and minimize these impacts.

References

- Ambrose, J. 2009. Personal Communication. Email to M. Novotney. March 16, 2009.
- Georgia Department of Natural Resources Coastal Resources Division (CRD). 2007. *Overview of the Coastal Management Program*. Georgia Department of Natural Resources. Coastal Resources Division. Brunswick, GA.
<http://crd.dnr.state.ga.us/content/displaycontent.asp?txtDocument=54>. Accessed: August 20, 2008.
- Georgia Department of Natural Resources Wildlife Resources Division (WRD). 2005. *A Comprehensive Wildlife Conservation Strategy for Georgia*. Georgia Department of Natural Resources. Wildlife Resources Division. Social Circle, GA. Available Online:
<http://www1.gadnr.org/cwcs/Documents/strategy.html>.
- Georgia Humanities Council (GHC) and University of Georgia Press (UGP). 2008a. "Natural History of the Okefenokee Swamp". *New Georgia Encyclopedia: Land and Resources*. Georgia Humanities Council and University of Georgia Press.
<http://www.georgiaencyclopedia.org/>. Accessed: March 3, 2008.
- Georgia Humanities Council (GHC) and University of Georgia Press (UGP). 2008b. "Tidal Marshes." *New Georgia Encyclopedia: Land and Resources*. Georgia Humanities Council and University of Georgia Press. <http://www.georgiaencyclopedia.org/>. Accessed: March 3, 2008.
- Heimlich, R., K. Wiebe, R. Claassen, D. Gadsby and R. House. 1998. *Wetlands and Agriculture: Private Interests and Public Benefits*. Agricultural Economic Report No. 765. U.S. Department of Agriculture. Economic Research Service. Resource Economics Division.
<http://www.ers.usda.gov/publications/aer765/>. Accessed: October 21, 2008.
- Holland, F. and D. Sanger. 2008. *Tidal Creek Habitats: Sentinels of Coastal Health*. Hollings Marine Laboratory. Charleston, SC.
- Houlahan, J., C. Findlay, B. Schmidt, A. Meyer and S. Kuzmin. 2000. "Quantitative Evidence for Global Amphibian Population Declines." *Nature*. 404: 752-755.
- Means, D.B. 2008. Personal Communication. Email to M. Novotney. December 20, 2008.
- Merrill, T.R., Coastal Georgia Regional Development Center (CGRDC) and EMC Engineering Services, Inc. 2006. *Green Growth Guidelines: A Low Impact Development Strategy for Coastal Georgia*. Prepared for: Georgia Department of Natural Resources (DNR) Coastal Management Program. Brunswick, GA. Available Online:
<http://crd.dnr.state.ga.us/content/displaycontent.asp?txtDocument=969>.
- Morton, T. 1997. *Draining to the Ocean: The Effects of Stormwater Pollution on Coastal Waters*. American Oceans Campaign. Washington, DC.
- Priest, S. 2004. *Evaluation of Groundwater Contribution to Streamflow in Coastal Georgia and Adjacent Parts of Florida and South Carolina*. Scientific Investigations Report 2004-5265. U.S. Geological Survey. Reston, VA.

- U.S. Army Corps of Engineers (US ACOE). 1987. *Wetlands Delineation Manual*. U.S. Army Corps of Engineers. Waterways Experiment Station. Environmental Laboratory. Vicksburg, MS.
- U.S. Environmental Protection Agency (US EPA). 1993. *Guidance Specifying Management Measures for Sources of Nonpoint Pollution in Coastal Waters*. EPA-840-B-92-002. U.S. Environmental Protection Agency. Office of Wetlands, Oceans and Watersheds. Washington, DC. Available Online: <http://www.epa.gov/nps/MMGI/>.
- U.S. Environmental Protection Agency (US EPA). 1998. *The Beach and Your Coastal Watershed*. Coastal Watershed Factsheet Series. EPA 842-F-98-010. U.S. Environmental Protection Agency. Office of Water. Washington, DC.
- U.S. Fish and Wildlife Service (USFWS) and U.S. Census Bureau (USCB). 2008. *2006 National Survey of Fishing, Hunting, and Wildlife-Associated Recreation*. FHW-06-NAT. U.S. Fish and Wildlife Service and U.S. Census Bureau. Washington, DC. http://training.fws.gov/library/nat_survey2006_final.pdf. Accessed: March 20, 2009.
- Wilderness Institute. 2008. "Cumberland Island Wilderness." *National Wilderness Preservation System*. Wilderness Institute. <http://www.wilderness.net/index.cfm?fuse=NWPS&sec=wildView&WID=145>. Accessed: December 30, 2008.
- Wright, T., J. Tomlinson, T. Schueler, K. Cappiella, A. Kitchell and D. Hirschman. 2006. *Direct and Indirect Impacts of Urbanization on Wetland Quality*. Article 1. Wetlands and Watersheds Article Series. Center for Watershed Protection. Ellicott City, MD. Available Online: http://www.cwp.org/Resource_Library/Special_Resource_Management/wetlands.htm.

3.0 The Need for Natural Resource Protection and Stormwater Management

3.1 Overview

As documented in Section 2.0, a variety of aquatic and terrestrial resources can be found within Georgia's 24-county coastal region. These valuable natural resources provide habitat, food and shelter for many important resident and migratory organisms and contribute greatly to the region's natural beauty, economic well-being and quality of life. They have also, at least in part, contributed to the significant population growth that has occurred within the region over the last four decades.

Between 1970 and 2000, the number of people living in Bryan, Bulloch, Camden, Chatham, Effingham, Glynn, Liberty, Long, McIntosh and Screven Counties (Figure 3.1) increased by nearly 62 percent (COGRD, 2006). This population growth has continued over the last eight years and is not expected to stop anytime soon. Recent population projections (Table 3.1) have forecasted that the population of this 10-county study area will increase by an additional 32 percent by 2015 and an additional 51 percent by 2030 (COGRD, 2006).

Although the 10-county study area that was the focus of this particular population study is not synonymous with either the Coastal Nonpoint Source Management Area or Area of Special Interest (i.e., Bryan, Camden, Chatham, Effingham, Glynn, Liberty, Long and McIntosh Counties are part of the Coastal Nonpoint Source Management Area, Bulloch County is part of the Area of Special Interest and Screven County is not part of either the Coastal Nonpoint Source Management Area or Area of Special Interest), similar population growth can be expected to occur within these areas over the next two decades. This population growth will undoubtedly cause additional land development to occur throughout the 24-county coastal region.

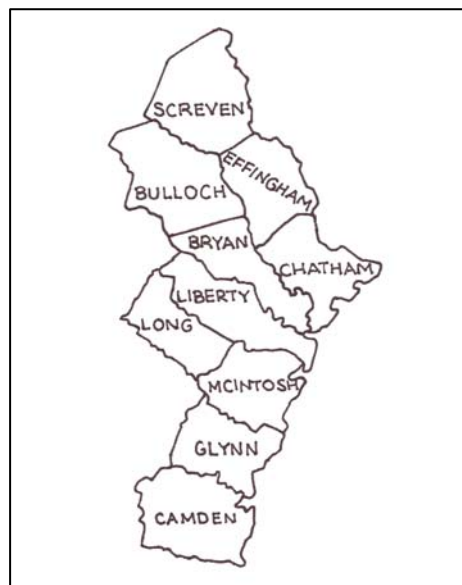

Figure 3.1: 10-County Population Study Area
(Source: Center for Watershed Protection)

Table 3.1: Projected Population Growth in the 10-County Population Study Area
(Source: COGRD, 2006)

County	Projected Population					
	2000	2010	2015	2020	2025	2030
Bryan	23,417	35,203	38,815	41,746	44,134	45,986
Bulloch	55,983	68,618	72,388	75,507	79,475	82,111
Camden	43,664	58,251	62,257	65,453	68,382	70,997
Chatham	232,048	262,138	275,057	286,869	297,352	307,472
Effingham	37,535	54,478	66,469	71,685	76,043	79,935
Glynn	67,568	81,368	87,118	92,121	96,581	100,483
Liberty	61,610	75,656	79,698	82,856	86,014	89,163
Long	10,304	15,537	17,705	19,568	21,163	22,607
McIntosh	10,847	14,262	15,751	16,939	17,918	18,626
Screven	15,375	20,058	22,070	23,872	25,398	26,779
Total	558,351	685,569	737,328	776,616	812,460	844,159

Although the land development process can help fuel economic growth, it can also have a wide range of unintended negative impacts on coastal Georgia's terrestrial and aquatic resources, as documented below. Without an effort to control and minimize these impacts, the anticipated population growth and associated land development activities have the potential to significantly impair the natural resources that contribute so greatly to the region's natural beauty, economic well-being and quality of life that, at least in part, make it such a desirable place to live.

3.2 Direct Impacts of Land Development

The land development process significantly alters the landscape by converting it from a natural state to a developed condition. During this process, clearing and grading are used to remove trees, shrubs and other vegetation, while cutting and filling are used to fill in natural drainage features and depressional areas to create clear and level building sites (Figure 3.2). These land disturbing activities can have direct negative impacts on both terrestrial and aquatic resources, often leading to the complete loss or destruction of these valuable resources.



Figure 3.2: Clear and Level Building Site
(Source: Atlanta Regional Commission, 2001)

Terrestrial resources are particularly vulnerable to the direct impacts of the land development process. For example, nearly 97 percent of all longleaf pine-wiregrass savannas (Section 2.3.9), which once covered approximately 90 million acres in the southeastern United States, have been lost or completely destroyed (WRD, 2005). Although fire suppression efforts have also contributed to the demise of this valuable terrestrial resource, many of these losses can be attributed to the land development process, which was used to convert these native forest communities into silvicultural, agricultural or urban land.

Wetlands are also particularly vulnerable to the direct impacts of the land development process. In fact, since 1780, more than 53 percent of all of the wetlands, both coastal and freshwater, that once existed in the contiguous U.S. have been lost to the direct impacts of the land development process (Wright et al., 2006, Dahl, 2006, Dahl, 2000, Dahl and Johnson, 2001, Dahl, 1990). In Chatham, Bryan, Liberty, McIntosh Counties alone, over 60,000 acres of forested wetlands have been converted to other land uses since 1974 (NARSAL, 2008). Although improved federal, state and local regulations have helped slow the rate of wetland loss over the last few decades, land development activities, such as filling, draining, dredging and impounding, continue to threaten the health of these and other important natural resources in coastal Georgia.

3.3 Indirect Impacts of Land Development

Any natural resources, and, in particular, any aquatic resources, that are not directly impacted by clearing, grading and other land disturbing activities, may still be negatively affected by the land development process. In converting the landscape from a natural state to a developed condition, the land development process fundamentally changes the characteristics of stormwater runoff. These changes, and the negative impacts that they can have on the aquatic resources of coastal Georgia, are described in more detail below.

3.3.1 Effects of Land Development on Stormwater Runoff

Additional information about the effects of the land development process on stormwater runoff, which includes changes in stormwater runoff quantity, quality and temperature, is provided below.

Effects of Land Development on Stormwater Quantity



Figure 3.3: Land Disturbing Activities Alter Site Hydrology

(Source: Center for Watershed Protection)

The effects of land development on stormwater quantity start the moment that the land development process begins. When a site is disturbed, its hydrology is fundamentally altered (Figure 3.3). Clearing removes the trees, shrubs and other vegetation that once reduced stormwater runoff volumes through the hydrologic processes of interception, evaporation and transpiration. Grading removes the native soils and natural depressional areas that once worked to retain rainfall and stormwater runoff on site. Compaction reduces the infiltration capacity of the underlying soils and increases the amount of rainfall that is converted to stormwater runoff. And, at the end of the process, the addition of roads, parking lots,

rooftops and other impervious surfaces only works to further increase stormwater runoff volumes. In the end, much of the rainfall that was once retained on a development site, through the hydrologic processes of interception, evapotranspiration and infiltration, is now converted to stormwater runoff.

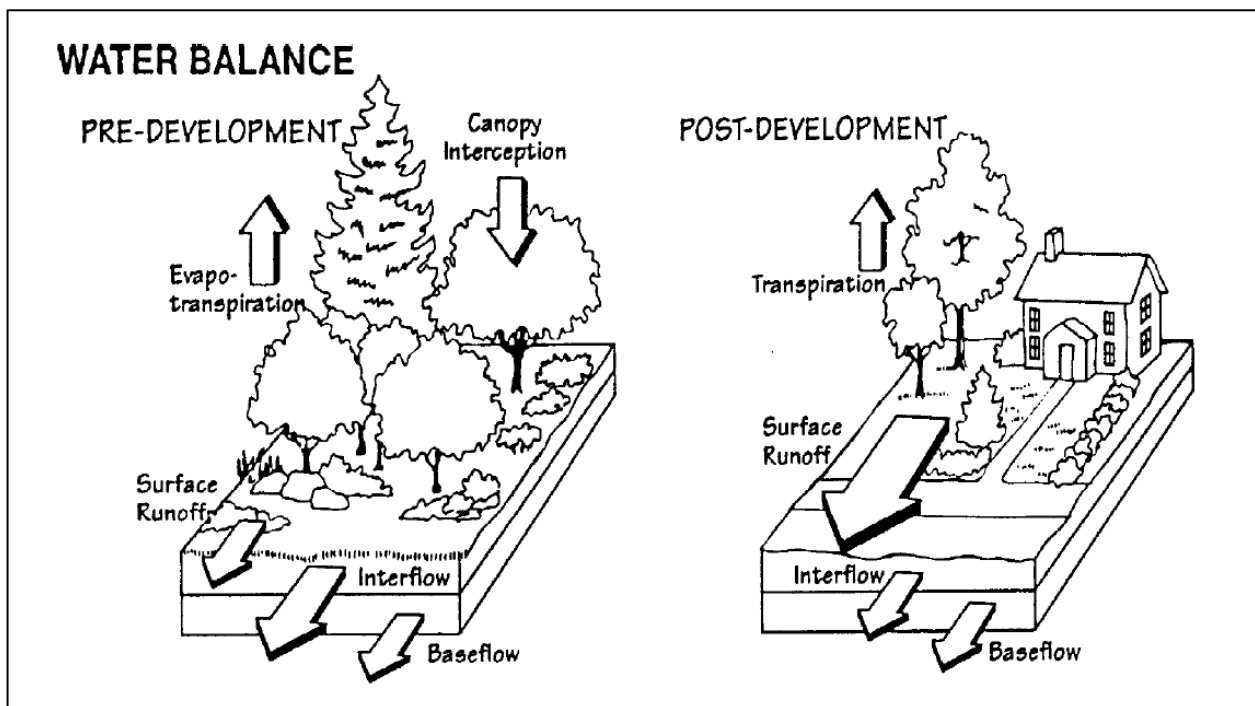

Figure 3.4: Changes in Site Hydrology Resulting from the Land Development Process

(Source: Schueler, 1987)

Previous studies (Pitt, 1994, Schueler, 1987) have shown that total stormwater runoff volumes can increase dramatically as a result of the land development process. Because more rainfall is converted to stormwater runoff on a development site, less rainfall becomes available to recharge groundwater aquifers and provide baseflow to aquatic resources, such as rivers, streams and wetlands, during dry weather (Figure 3.4).

The land development process not only increases stormwater runoff volumes and decreases groundwater recharge, but also dramatically increases the rate at which stormwater runoff is carried off the land. Impervious surfaces, such as roads, parking lots and rooftops, and compacted pervious surfaces, such as lawns, parks and athletic fields, increase stormwater runoff velocities and decrease the amount of time that it takes for stormwater runoff to reach both on-site and downstream aquatic resources. This effect is further exacerbated by drainage system improvements, such as curbs and gutters, storm drains and man-made ditches, that are designed to quickly convey stormwater runoff away from developed areas and into downstream aquatic resources. These increased stormwater runoff velocities lead to increased peak discharge rates, which can be two to five times higher on a developed site than on an undeveloped site (ARC, 2001).

Effects of Land Development on Stormwater Quality

The land development process not only affects stormwater quantity, but also stormwater quality. Pollutants, including sediment, trash and construction debris from cleared, graded and compacted development sites are picked up and washed into receiving streams and other aquatic resources during storm events. As the land development process proceeds, roads, parking lots, rooftops and other impervious surfaces replace the native soils and vegetation that once worked to reduce stormwater runoff volumes and pollutant loads through the processes of interception, evapotranspiration, filtration and infiltration. Pollutants that now accumulate on these impervious surfaces and on compacted pervious surfaces, such as lawns, parks and athletic fields, during dry weather are picked up and transported into receiving waters during rainfall events (Figure 3.5). In the end, greater amounts of stormwater pollution are generated and transported into on-site and downstream aquatic resources as a result of the land development process.



Figure 3.5: Pollutants that Accumulate on Impervious Surfaces are Transported Downstream During Storm Events
(Source: Atlanta Regional Commission, 2001)

Stormwater pollutants come from a variety of diffuse and scattered sources, many of which are a direct or indirect result of the land development process. These nonpoint source pollutants, which are the leading source of water quality degradation in the state of Georgia (ARC, 2001), and a number of other states across the country, include:

- **Sediment:** The sediment found in stormwater runoff is typically a result of land disturbing activities, atmospheric deposition or surface or streambank erosion. Sediment particles can adsorb other stormwater pollutants, such as nutrients, metals, hydrocarbons and pesticides, and transport them into receiving streams, wetlands and other aquatic resources.

- Nutrients: The nutrients found in stormwater runoff, which include nitrogen and phosphorus, are typically a result of fertilizer and detergent use, pet and animal waste, leaves, grass clippings, sanitary sewer overflows, septic system discharges and atmospheric deposition.
- Bacteria: The bacteria and other pathogenic organisms found in stormwater runoff, whose concentrations routinely exceed public health standards for contact recreation, are typically a result of pet and animal waste, sanitary sewer overflows and septic system discharges.
- Organic Matter: The organic matter found in stormwater runoff is typically a result of leaves, grass clippings, pet and animal waste, sanitary sewer overflows and septic system discharges.
- Metals: The heavy metals, such as lead, zinc, copper and cadmium, found in stormwater runoff are typically a result of atmospheric deposition, vehicle wear and commercial, industrial and hazardous waste sites.
- Hydrocarbons: The hydrocarbons found in stormwater runoff are typically a result of vehicle wear, chemical spills, restaurant grease traps and the improper disposal of waste oil and grease.
- Pesticides: The insecticides, herbicides and other pesticides found in stormwater runoff are typically a result of lawn care and maintenance activities, chemical spills and atmospheric deposition.
- Trash and Debris: Considerable quantities of trash and debris typically accumulate on impervious surfaces and get picked up and transported into receiving waters by stormwater runoff. This trash and debris can accumulate in the stormwater conveyance system, causing clogging and other maintenance problems, and in downstream aquatic resources.

As documented below in Section 3.3.2, these pollutants can have a number of negative impacts on the aquatic resources of coastal Georgia, including reduced water quality, reduced dissolved oxygen levels, increased primary productivity (e.g., eutrophication, algal blooms), sediment contamination, shellfish bed contamination and closure, degradation of habitat and a general decline in wildlife abundance and diversity.

Effects of Land Development on Stormwater Temperature

The land development process not only affects stormwater quantity and quality, but also affects stormwater temperature. Impervious surfaces, such as rooftops, roads and parking lots, tend to retain heat when exposed to sunlight. As stormwater runoff moves over these impervious surfaces, it increases in temperature. As documented below in Section 3.3.2, when this "heated" stormwater runoff is conveyed into a river, stream, wetland or other aquatic resource, it can decrease the amount of dissolved oxygen contained within the water column, which reduces the amount of oxygen that is available to aquatic organisms.

3.3.2 Effects of Land Development on Aquatic Resources

The changes in stormwater runoff resulting from the land development process can have a wide range of negative impacts on coastal Georgia's valuable aquatic resources. Additional information about these impacts is provided below.

3.3.2.1 Effects of Land Development on Freshwater Resources

The indirect impacts that the land development process can have on the freshwater resources of coastal Georgia, which include rivers, streams and freshwater wetlands, are documented below.

Rivers and Streams

The changes in stormwater quantity, quality and temperature resulting from the land development process can have a number of negative impacts on coastal Georgia's freshwater rivers and streams. These impacts, which have been well documented by the Center for Watershed Protection (CWP, 2003), include:

- Increased Channel Forming Events: The increased stormwater runoff rates and volumes resulting from the land development process cause an increase in the frequency and duration of channel forming bankfull and near bankfull events (Figure 3.6). These channel forming events create streambank erosion and stream channel enlargement.
- Increased Flooding: The increased stormwater runoff rates and volumes resulting from the land development process also cause an increase in the frequency, duration and severity of overbank and extreme flooding events (Figure 3.7). These flooding events can cause property damage and endanger public health and safety.
- Decreased Baseflow: The increased stormwater runoff volumes resulting from the land development process reduce the amount of rainfall available to recharge shallow groundwater aquifers and feed freshwater rivers and streams during dry weather.
- Stream Channel Enlargement: Stream channels enlarge (Figure 3.8) in order to accommodate the increased peak discharges resulting from the land development process. A stream channel may become much wider and deeper in order to



Figure 3.6: Bankfull Event
(Source: Atlanta Regional Commission, 2001)



Figure 3.7: Overbank Flooding Event
(Source: Center for Watershed Protection)

accommodate the increased stormwater runoff rates and volumes resulting from the land development process.

- Loss of Riparian Vegetation: As streambanks are gradually undercut, scoured and eroded away, the roots of trees and other plants that are found along the stream corridor may become exposed. Consequently, a significant amount of riparian vegetation may be undercut, uprooted and conveyed downstream during storm events (Figure 3.8).



Figure 3.8: Stream Channel Enlargement and Loss of Riparian Vegetation

(Source: Center for Watershed Protection)

- Degradation of Habitat: The increased stormwater runoff rates and volumes resulting from the land development process scour stream beds and wash away valuable aquatic habitat. The increased sediment loads that result from land disturbing activities, as well as from surface and streambank erosion, can also degrade aquatic habitat, filling in streambeds and destroying the important pool-riffle structure found in many undisturbed freshwater rivers and streams.
- Increased Temperatures: The increased stormwater runoff temperatures resulting from the land development process can raise the temperature of the water found within freshwater rivers and streams. Since some aquatic organisms can survive only within a specific temperature range (e.g., trout, stoneflies), increased river and stream temperatures can lead to an overall decline in wildlife abundance and diversity.
- Degradation of Water Quality: The increased stormwater pollutant loads resulting from the land development process reduce the overall water quality of freshwater rivers and streams. This water quality degradation negatively impacts many of the ecological functions that these important natural resources provide.

- Reduced Dissolved Oxygen Levels: The increased amounts of organic matter found in urban stormwater runoff, and the increased stormwater runoff temperatures that result from the land development process, reduce the amount of dissolved oxygen found in freshwater rivers and streams. If the amount of dissolved oxygen found in the water column gets low enough, fish kills (Figure 3.9) and the loss of other aquatic organisms can result. Low dissolved oxygen levels can also force the release of harmful pollutants such as metals, nutrients, hydrocarbons and pesticides that have accumulated within the sediments found at the bottom of freshwater rivers and streams.



Figure 3.9: Fish Kill of Atlantic Menhaden

(Source: Guadagnoli et al., 2005)

- Decline in Wildlife Abundance and Diversity: When the increased stormwater runoff rates, volumes and pollutant loads resulting from the land development process degrade habitat and water quality, the abundance and diversity of aquatic organisms found in freshwater rivers and streams may be significantly reduced. Sensitive “keystone” organisms that require high quality habitat may become stressed and be gradually replaced by organisms that are more tolerant of the degraded conditions.
- Reduced Recreational Value: The increased trash, debris and pollutant loads found in urban stormwater runoff can accumulate in freshwater rivers and streams and detract from their natural beauty and recreational value.

Freshwater Wetlands

The changes in stormwater quantity and quality resulting from the land development process can have a number of negative impacts on coastal Georgia’s freshwater wetlands. These impacts, which have been well documented by the Center for Watershed Protection (Wright et al., 2006), include:

- Increased Ponding: The increased stormwater runoff rates and volumes resulting from the land development process can cause increased ponding within freshwater wetlands. This increased ponding can stress native wetland plant communities (Figure 3.10), particularly if the wetlands did not previously receive large inputs of stormwater runoff.
- Increased Water Level Fluctuations: The increased stormwater runoff rates and volumes resulting from the land development process can cause increased water level fluctuations in freshwater wetlands. These increased water level fluctuations can stress native wetland plant communities and lead to a decline in plant and wildlife abundance and diversity.
- Decreased Baseflow: The increased stormwater runoff volumes resulting from the land development process reduce the amount of rainfall available to recharge shallow groundwater aquifers and provide a steady supply of baseflow to freshwater wetlands.
- Degradation of Habitat: The increased ponding and water level fluctuations, and decreased baseflow, resulting from the land development process can stress native wetland plant communities and degrade the habitat value of freshwater wetlands. The increased sediment loads resulting from the



Figure 3.10: Increased Ponding in a Freshwater Wetland

(Source: Center for Watershed Protection)



Figure 3.11: Excessive Sediment Accumulation in a Freshwater Wetland

(Source: Center for Watershed Protection)

land disturbing activities, as well as from surface and streambank erosion, can also degrade the habitat value of wetlands by filling them in (Figure 3.11).

- Degradation of Water Quality: The increased stormwater pollutant loads resulting from the land development process reduce the overall water quality of freshwater wetlands. This water quality degradation negatively impacts many of the ecological functions that these important natural resources provide.
- Increased Primary Productivity: The increased nutrient loads found in urban stormwater runoff unnaturally increases the primary productivity of freshwater wetlands, promoting algal growth and forcing the native wetland plant community to compete for available nutrients (Figure 3.12). The competition can stress native wetland plant communities and lead to an overall decline in plant and wildlife abundance and diversity.
- Sediment Contamination: The metals, hydrocarbons and pesticides found in urban stormwater runoff can become attached to the surface of sediment particles and accumulate within freshwater wetlands. This accumulation can cause sediment contamination and expose aquatic and terrestrial organisms alike to the harmful effects of these pollutants.
- Decline in Wildlife Abundance and Diversity: When the increased stormwater runoff rates, volumes and pollutant loads resulting from the land development degrade habitat and water quality, the abundance and diversity of plants, animals and other organisms found in freshwater wetlands may be significantly reduced. In these situations, native wetland plant communities tend to be replaced by invasive species, and sensitive macroinvertebrate, amphibian, reptile and bird populations become stressed and gradually replaced by populations that are more tolerant of the degraded conditions. This can result in the local extinction of native aquatic and terrestrial organisms.
- Reduced Aesthetic Value: The increased trash, debris and pollutant loads found in urban stormwater runoff can accumulate in freshwater wetlands, detracting from their natural beauty and aesthetic value (Figure 3.13).



Figure 3.12: Increased Productivity in a Freshwater Wetland

(Source: Center for Watershed Protection)



Figure 3.13: Trash and Debris Reduce the Aesthetic Value of Freshwater Wetlands

(Source: Center for Watershed Protection)

3.3.2.2 Effects of Land Development on Estuarine Resources

The indirect impacts that the land development process can have on Georgia's estuarine resources, which include tidal rivers, sounds, tidal creeks, coastal marshlands and tidal flats are documented below. Although these impacts are primarily a result of the increased pollutant loads contained in post-construction stormwater runoff, increased stormwater runoff rates and volumes can also have a number of negative impacts on the region's vital estuarine resources.

- **Increased Salinity Fluctuations:** The increased stormwater runoff rates and volumes resulting from the land development process cause increased salinity fluctuations within estuarine resources (Holland et al., 2004, Dustan, 2004, Lerberg et al., 2000). The increased salinity fluctuations can negatively affect the health of shrimp (Figure 3.14), crabs and other important aquatic organisms (Vernberg et al., 1996) and lead to an overall decline in wildlife abundance and diversity (Callaway and Zedler, 1998).
- **Decreased Baseflow:** The increased stormwater runoff volumes resulting from the land development process tend to reduce the amount of rainfall available to recharge shallow groundwater aquifers and provide a steady supply of baseflow to estuarine resources, such as tidal creeks and coastal marshlands.
- **Degradation of Habitat:** The increased salinity fluctuations and decreased baseflow resulting from the land development process can degrade the overall habitat value of estuarine resources (Mallin and Lewitus, 2004). The increased sediment loads resulting from land development activities, as well as from surface and streambank erosion, can also degrade the value of the habitat provided by these important natural resources.
- **Degradation of Water Quality:** The increased stormwater pollutant loads resulting from the land development process reduce the overall water quality of estuarine resources. This water quality degradation negatively impacts many of the ecological functions that these important natural resources provide.
- **Increased Primary Productivity:** The increased nutrient loads found in urban stormwater runoff increases the primary productivity of estuarine resources, creating eutrophic conditions and promoting algal growth, which leads to the production of algal blooms (Mallin and Lewitus, 2004, Howarth et al., 2000) (Figure 3.15). Algal blooms prevent



Figure 3.14: Salinity Fluctuations Can Negatively Affect the Health of Shrimp and Other Aquatic Organisms

(Source: National Oceanic and Atmospheric Administration)

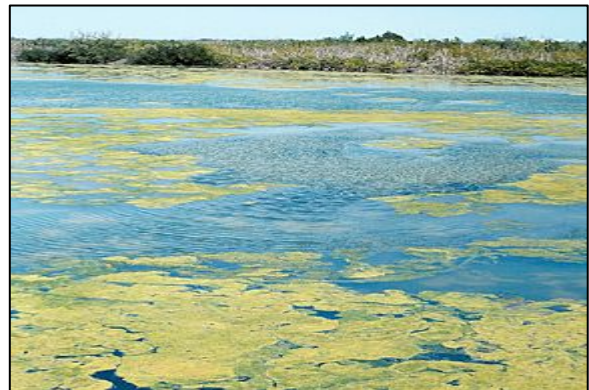

Figure 3.15: Algal Bloom

(Source: St. Johns River, FL Water Management District)

sunlight from penetrating the water column and can lead to the degradation or complete loss of submerged or partially-submerged aquatic vegetation (Howarth et al., 2000).

- Reduced Dissolved Oxygen Levels: The increased amounts of organic matter found in urban stormwater runoff, and the increased primary productivity resulting from the land development process, reduce the amount of dissolved oxygen found in estuarine resources (Dustan, 2004, Mallin et al., 2006). If the amount of dissolved oxygen found in the water column becomes low enough, hypoxic or anoxic conditions can result, which can lead to fish kills and the loss of other aquatic organisms. Low dissolved oxygen levels can also force the release of harmful pollutants, such as metals, nutrients, hydrocarbons and pesticides, that have accumulated within the sediments found at the bottom of estuarine resources.
- Shellfish Harvesting Area Contamination and Closure: The increased bacteria loads found in urban stormwater runoff can cause the contamination and closure of shellfish harvesting areas (Mallin and Lewitus, 2004, Mallin et al., 2001, Mallin et al., 2000), preventing the harvest and consumption of shellfish from these areas (Figure 3.16). The contamination of shellfish harvesting areas decreases the amount of commercial and recreational shellfishing that can occur in estuarine waters.
- Sediment Contamination: The metals, hydrocarbons and pesticides found in urban stormwater runoff can become attached to the surface of sediment particles and accumulate within estuarine resources. This accumulation can cause sediment contamination (Mallin and Lewitus, 2004, Van Dolah et al., 2004, Paul et al., 2002, Sanger et al., 1999a, Sanger et al., 1999b) and expose both aquatic and terrestrial organisms, including humans, to the harmful effects of these pollutants.
- Decline in Wildlife Abundance and Diversity: When the increased stormwater runoff rates, volumes and pollutant loads resulting from the land development process degrade habitat and water quality, the abundance and diversity of plants, animals and other organisms found in estuarine resources, such as tidal rivers, sounds, tidal creeks, coastal marshlands and tidal flats, may be significantly reduced (Bilkovic et al., 2006, Mallin and Lewitus, 2004).
- Reduced Recreational Value: The increased trash, debris and pollutant loads found in urban stormwater runoff can accumulate in estuarine resources and detract from their natural beauty and recreational value.



Figure 3.16: Shellfish Bed Contamination and Closure
(Source: Atlanta Regional Commission, 2001)

3.3.2.3 Effects of Land Development on Marine Resources

The primary indirect impact that the land development process can have upon Georgia's marine resources, which include near coastal waters and beaches, is beach contamination (Figure 3.17). The bacteria and other pathogenic organisms found in urban stormwater runoff,

whose concentrations routinely exceed public health standards for contact recreation, pose significant threats to public health and safety. Contact with waters that have high levels of bacteria and other pathogenic organisms can cause a number of illnesses, including respiratory and gastrointestinal illnesses and infections (Mallin, 2006, Haile et al., 1999). Because of the threat to public health and safety, the contamination of near coastal waters in coastal Georgia can, and often does, lead to the issuance of beach advisories (NRDC, 2006).

3.3.2.4 Effects of Land Development on Groundwater Resources

The indirect impacts that the land development process can have on the groundwater resources of coastal Georgia, which include groundwater aquifers, are primarily a result of the changes in stormwater quantity that result from the process. These impacts include:

- **Decreased Groundwater Recharge:** The increased stormwater runoff volumes resulting from the land development process reduce the amount of rainfall available to recharge shallow groundwater aquifers, which normally provide a steady supply of baseflow to rivers, streams and other aquatic resources. Without this valuable baseflow, the hydrology of these vital aquatic resources may be altered, which can stress native wetland plant communities and lead to an overall decline in plant and wildlife abundance and diversity. Decreased groundwater recharge can also reduce the amount of rainfall available to recharge the deeper, confined aquifers that serve as the principal source of potable water for coastal Georgia.

Figure 3.18 identifies the areas that are known to provide groundwater recharge to Georgia's confined groundwater aquifer systems. Although there are a number of these recharge areas located within the Coastal Nonpoint Source Management Area and Area of Special Interest, none of them provides recharge to the Floridan aquifer system, which supplies most of the region's potable water (Section 2.2.4.1). Instead, many of them provide groundwater recharge to the shallower Brunswick and unconfined surficial aquifer systems.

- **Groundwater Drawdown:** In recent years, population growth and the associated land development activities have increased water demand, which has increased the amount of water withdrawn from coastal



Figure 3.17: Beach Contamination
(Source: Elizabeth Cheney)

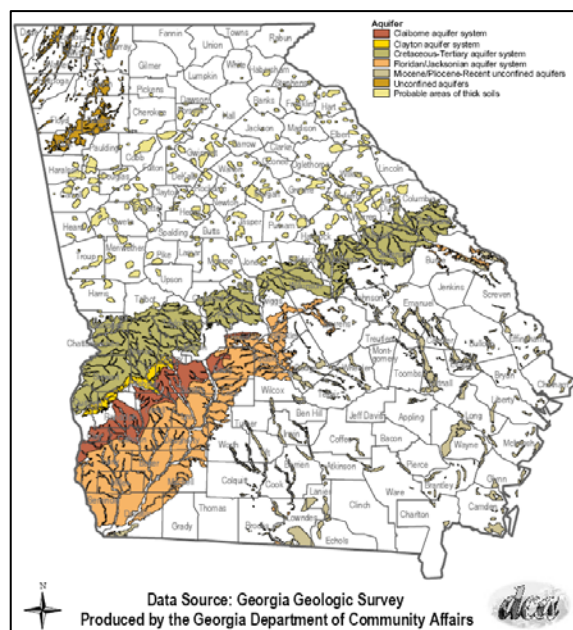

Figure 3.18: Known Confined Groundwater Aquifer Recharge Areas
(Source: Georgia Department of Community Affairs)

Georgia's groundwater aquifers. The increased withdrawal has caused an overall drawdown of these groundwater aquifers and has formed a cone of depression in the Upper Floridan aquifer beneath Savannah, Georgia. This cone of depression has reversed the gradient in the aquifer and has caused the lateral encroachment of seawater into the aquifer near Hilton Head Island, South Carolina and the vertical intrusion of seawater into the aquifer near Brunswick, Georgia (USGS, 2001).

3.4 Addressing the Impacts with Natural Resource Protection and Stormwater Management

As documented above, the land development process can have both direct and indirect impacts on coastal Georgia's terrestrial and aquatic resources. The remainder of this Coastal Stormwater Supplement (CSS) provides information about an integrated, green infrastructure-based approach to natural resource protection, stormwater management and site design that can be used to control and minimize these impacts. It provides Georgia's coastal communities with a wealth of information that they can use to ensure that the anticipated population growth and associated land development activities do not significantly impair the natural resources that contribute so greatly to the region's natural beauty, economic well-being and quality of life.

The integrated approach to natural resource protection, stormwater management and site design presented in this CSS involves:

- Identifying the valuable natural resources found on a development site prior to the start of any land disturbing activities
- Protecting these valuable natural resources from the direct impacts of the land development process through the use of better site planning techniques
- Limiting land disturbance and the amount of impervious and disturbed pervious cover created on development sites through the use of better site design techniques
- *Reducing* post-construction stormwater runoff rates and volumes, through the use of better site planning and design techniques and low impact development practices, to:
 - Help maintain pre-development site hydrology
 - Help prevent downstream water quality degradation
 - Help prevent downstream flooding and erosion
- *Managing* post-construction stormwater runoff rates, through the use of stormwater management practices, to:
 - Help prevent downstream water quality degradation
 - Help prevent downstream flooding and erosion

The remainder of this CSS provides information about implementing this approach, beginning with a comprehensive set of post-construction stormwater management and site planning and design criteria that can be applied to new development and redevelopment activities occurring within the Coastal Nonpoint Source Management Area and Area of Special Interest.

References

- Atlanta Regional Commission (ARC). 2001. *Georgia Stormwater Management Manual*. Volume 2. Technical Handbook. Atlanta Regional Commission. Atlanta, GA. Available Online: <http://www.georgiastormwater.com/>.
- Bilkovic, D.M., M. Roggero, C.H. Hershner and K.H. Havens. 2006. "Influence of Land Use on Macrobenthic Communities in Nearshore Estuarine Habitats." *Estuaries and Coasts*. 29(6B): 1185-1195.
- Callaway, J.C. and J.B. Zedler. 1998. "Interactions Between a Salt Marsh Native Perennial (*Salicornia virginica*) and an Exotic Annual (*Polypogon monspeliensis*) Under Varied Salinity and Hydroperiod." *Wetlands Ecology and Management*. 5: 179-194.
- Center for Watershed Protection (CWP). 2003. Impacts of Impervious Cover on Aquatic Systems. Center for Watershed Protection. Ellicott City, MD. Available Online: <http://www.cwp.org/Store/guidance.htm>.
- Center for Quality Growth and Regional Development (CQGRD). 2006. *Georgia Coast 2030: Population Projections for the 10-County Coastal Region*. Georgia Institute of Technology. Center for Quality Growth and Regional Development. Atlanta, GA.
- Dahl, T.E. 2006. *Status and Trends of Wetlands in the Conterminous United States 1998-2004*. U.S. Department of the Interior. U.S. Fish and Wildlife Service. Washington, DC.
- Dahl, T.E. 2000. *Status and Trends of Wetlands in the Conterminous United States 1986-1997*. U.S. Department of the Interior. U.S. Fish and Wildlife Service. Washington, DC.
- Dahl, T.E. and C.E. Johnson. 1991. *Status and Trends of Wetlands in the Conterminous United States Mid-1970s-Mid-1980s*. U.S. Department of the Interior. U.S. Fish and Wildlife Service. Washington, DC.
- Dahl, T.E. 1990. *Wetland Losses in the United States 1780s-1980s*. U.S. Department of the Interior. U.S. Fish and Wildlife Service. Washington, DC.
- Dustan, P. 1994. *Stormwater Impacts on Creeks: Variability of Secondary Estuarine Watersheds*. College of Charleston. Charleston, SC.
- Guadagnoli, D., B. Good, J. Mackinnon, P. Flournoy, J. Harvey and L. Harwell. 2005. *The Condition of Georgia's Estuarine and Coastal Habitats 2000-2001 Interim Report*. Report Number 001. Georgia Department of Natural Resources. Coastal Resources Division. Brunswick, GA. Available Online: <http://crd.dnr.state.ga.us/content/displaycontent.asp?txtDocument=1003>.
- Haile, R.W., J.S. Witte, M. Gold. 1999. "The Health Effects of Swimming in Ocean Water Contaminated by Storm Drain Runoff." *Epidemiology*. 10(4): 355-363.
- Holland, A.F., D.M. Sanger, C.P. Gawle, S.B. Lerberg, M.S. Santiago, G.H.M. Riekerk, L.E. Zimmerman and G.I. Scott. 2004. "Linkages Between Tidal Creek Ecosystems and the Landscape and Demographic Attributes of Their Watersheds." *Journal of Experimental Marine Biology and Ecology*. 298: 151-178.

- Howarth, R.W., D. Anderson, J. Cloern, C. Elfring, C. Hopkinson, B. Lapointe, T. Malone, N. Marcus, K. McGlathery, A. Sharpley and D. Walker. 2000. "Nutrient Pollution of Coastal Rivers, Bays and Seas." *Issues in Ecology*. 7: 1-15.
- Lerberg, S.B., A.F. Holland and D.M. Sanger. 2000. "Responses of Tidal Creek Macroenthic Communities to the Effects of Watershed Development." *Estuaries*. 23(6): 838-853.
- Natural Resources Spatial Analysis Laboratory (NARSAL). 2008. *Georgia Land Use Trends (GLUT) Project*. University of Georgia. College of Agricultural and Environmental Sciences. Natural Resources Spatial Analysis Laboratory. Athens,GA. <http://narsal.uga.edu/glut.html>. Accessed: January 30, 2008.
- Mallin, M.A. 2006. "Wading In Waste." *Scientific American*. June 2006: 53-59.
- Mallin, M.A. and A.J. Lewitus. 2004. "The Importance of Tidal Creek Ecosystems." *Journal of Experimental Marine Biology and Ecology*. 298: 145-149.
- Mallin, M.A., S.H. Ensign, M.R. Mclver, G.C. Shank and P.K. Fowler. 2001. "Demographic, Landscape and Meteorological Factors Controlling the Microbial Pollution of Coastal Waters." *Hydrobiologia*. 460: 185-193.
- Mallin, M.A., K.E. Williams, E.C. Esham and R.P. Lowe. 2000. "Effect of Human Development on Bacteriological Water Quality in Coastal Watersheds." *Ecological Applications*. 10(4): 1047-1056.
- National Resources Defense Council (NRDC). 2006. *Testing the Waters: A Guide to Water Quality at Vacation Beaches: Georgia*. National Resources Defense Council. New York, NY.
- Paul, J.F., R.L. Comeleo and J. Copeland. 2002. "Landscape Metrics and Estuarine Sediment Contamination in the Mid-Atlantic and Southern New England Regions." *Journal of Environmental Quality*. 31: 836-845.
- Pitt, R. 1994. *Small Storm Hydrology*. Unpublished Manuscript. University of Alabama–Birmingham. Birmingham, AL.
- Sanger, D.M., A.F. Holland and G.I. Scott. 1999a. "Tidal Creek and Salt Marsh Sediments in South Carolina Coastal Estuaries I: Distribution of Trace Metals." *Archives of Environmental Contamination and Toxicology*. 37: 445-457.
- Sanger, D.M., A.F. Holland and G.I. Scott. 1999b. "Tidal Creek and Salt Marsh Sediments in South Carolina Coastal Estuaries II: Distribution of Organic Contaminants." *Archives of Environmental Contamination and Toxicology*. 37: 458-471.
- Schueler, T. 1987. *Controlling Urban Runoff: A Practical Manual for Planning and Designing Urban BMPs*. Metropolitan Washington Council of Governments. Department of Environmental Programs. Washington, DC.
- U.S. Geological Survey (USGS). 2001. *Coastal Groundwater at Risk: Saltwater Contamination at Brunswick, GA and Hilton Head Island, SC*. Water Resources Investigations Report 01-4107. U.S. Geological Survey. Available Online: <http://ga2.er.usgs.gov/coastal/coastalreport.cfm>.

- Van Dolah, R., P. Jutte, G. Riekerk, J. Felber, F. Holland and J. Scurry. 2004. *An Evaluation of Land Use Patterns Versus Estuarine Habitat Quality in South Carolina's Coastal Zone*. South Carolina Department of Health and Environment Control. Office of Ocean and Coastal Resource Management. Charleston, SC.
- Vernberg, W., G. Scott, S. Stroizer, J. Bemiss and J. Daugomah. 1996. "The Effects of Coastal Development on Watershed Hydrography and Transport of Organic Carbon." In: *Sustainable Development in the Southeastern Coastal Zone*. Eds. F.J. Vernberg, W.B. Vernberg and T. Siewicki. Belle W. Baruch Library in Marine Science. University of South Carolina. Columbia, SC.
- Wright, T., J. Tomlinson, T. Schueler, K. Cappiella, A. Kitchell and D. Hirschman. 2006. *Direct and Indirect Impacts of Urbanization on Wetland Quality*. Article 1. Wetlands and Watersheds Article Series. Center for Watershed Protection. Ellicott City, MD. Available Online: http://www.cwp.org/Resource_Library/Special_Resource_Management/wetlands.htm.

4.0 Stormwater Management and Site Planning and Design Criteria

4.1 Overview

This Section presents a comprehensive set of post-construction stormwater management and site planning and design criteria that can be applied to new development and redevelopment activities occurring within the Coastal Nonpoint Source Management Area and Area of Special Interest. The criteria provide the foundation for the integrated, green infrastructure-based approach to natural resource protection, stormwater management and site design detailed in this Coastal Stormwater Supplement (CSS). When used in combination with one another, they promote an integrated approach to natural resource protection, stormwater management and site design that involves:

- Identifying the valuable natural resources found on a development site prior to the start of any land disturbing activities
- Protecting these valuable natural resources from the direct impacts of the land development process through the use of better site planning techniques
- Limiting land disturbance and the amount of impervious and disturbed pervious cover created on development sites through the use of better site design techniques
- *Reducing* post-construction stormwater runoff rates and volumes, through the use of better site planning and design techniques and low impact development practices, to:
 - Help maintain pre-development site hydrology
 - Help prevent downstream water quality degradation
 - Help prevent downstream flooding and erosion
- *Managing* post-construction stormwater runoff rates, through the use of stormwater management practices, to:
 - Help prevent downstream water quality degradation
 - Help prevent downstream flooding and erosion

The post-construction stormwater management and site planning and design criteria presented here are *recommended* for use throughout the Coastal Nonpoint Source Management Area and Area of Special Interest. They have been designed to help balance the protection of coastal Georgia's valuable terrestrial and aquatic resources with land development and economic growth. They have also been designed to help communities located within Georgia's 24-county coastal region comply with the requirements of various state and federal environmental policies, programs and regulations, including the National Pollution Discharge Elimination System (NPDES) Municipal Stormwater Program and Section 6217 of the Coastal Zone Act Reauthorization Amendments of 1990 (CZARA). Communities may adapt the criteria "as-is" or may review and modify them to meet local natural resource protection and stormwater management goals and objectives.

4.2 Applicability and Exemptions

4.2.1 Applicability

It is *recommended* that the post-construction stormwater management and site planning and design criteria presented below be applied to any new development or redevelopment activity that meets one or more of the following criteria:

- (1) New development that involves the creation of 5,000 square feet or more of impervious cover or that involves other land disturbing activities of one acre or more.

- (2) Redevelopment that involves the creation, addition or replacement of 5,000 square feet or more of impervious cover or that involves other land disturbing activities of one acre or more.
- (3) New development or redevelopment, regardless of size, that is part of a larger common plan of development, even though multiple, separate and distinct land disturbing activities may take place at different times and on different schedules.
- (4) New development or redevelopment, regardless of size, that involves the creation or modification of a stormwater hotspot, as defined in the Glossary.

4.2.2 Exemptions

The following activities may be exempted from the post-construction stormwater management and site planning and design criteria presented below:

- (1) New development or redevelopment that involves the creation, addition or replacement of less than 5,000 square feet of impervious cover and that involves less than one acre of other land disturbing activities.
- (2) New development or redevelopment activities on individual residential lots that are not part of a larger common plan of development and that do not meet any of the applicability criteria listed above.
- (3) Additions or modifications to existing single-family homes and duplex residential units that do not meet any of the applicability criteria listed above.

4.3 Site Planning and Design Criteria

Using the integrated approach to natural resource protection, stormwater management and site design detailed in this CSS involves considering natural resource protection and post-construction stormwater management *throughout* the site planning and design process. In order to help ensure that they are, it is *recommended* that the following site planning and design criteria (SP&D Criteria) be applied to any new development or redevelopment activity that meets one or more of the applicability criteria listed above (Section 4.2). These SP&D Criteria are briefly summarized in Table 4.1 below.

Criteria	Description
SP&D Criteria #1: Natural Resources Inventory	Prior to the start of any land disturbing activities (including any clearing and grading activities), acceptable site reconnaissance and surveying techniques should be used to complete a thorough assessment of the natural resources, both terrestrial and aquatic, found on a development site.
SP&D Criteria #2: Use of Green Infrastructure Practices	Green infrastructure practices, in the form of better site planning and design techniques and low impact development practices, should be used to the <i>maximum extent practical</i> during the creation of a stormwater management concept plan for a proposed development project.

Table 4.1: Summary of the Site Planning and Design Criteria

Criteria	Description
SP&D Criteria #3: Stormwater Management Concept Plan	A stormwater management concept plan should be prepared for all proposed development projects. The stormwater management concept plan should illustrate the layout of the proposed development project and should show, in general, how post-construction stormwater runoff will be managed on the development site.
SP&D Criteria #4: Stormwater Management Design Plan	A stormwater management design plan should be prepared for all proposed development projects. The stormwater management design plan should detail how post-construction stormwater runoff will be managed on the development site and should include maps, narrative descriptions and design calculations (e.g., hydrologic and hydraulic calculations) that show how the stormwater management and site planning and design criteria that apply to the development project have been met.
SP&D Criteria #5: Downstream Analysis	A downstream analysis should be performed to identify any additional overbank or extreme flooding that may result from an increase in stormwater runoff rates and volumes on a development site.
SP&D Criteria #6: Stormwater Management System Inspection and Maintenance Plan	Comprehensive inspection and maintenance plans should be developed for all post-construction stormwater management systems in order to help ensure that they will continue to function as designed over time.
SP&D Criteria #7: Erosion and Sediment Control Plan	An erosion and sediment control plan should be prepared for all proposed development projects. All erosion and sediment control plans should be prepared in accordance with requirements of the <i>Georgia Erosion and Sediment Control Act</i> (O.C.G.A. §12-7-1 through §12-7-22) and the state's National Pollutant Discharge Elimination System (NPDES) General Permit for Stormwater Discharges Associated with Construction Activities.
SP&D Criteria #8: Landscaping Plan	A landscaping plan should be prepared for all proposed development projects.
SP&D Criteria #9: Stormwater Pollution Prevention Plan	A stormwater pollution prevention plan should be developed for all proposed development projects involving the creation or modification of a stormwater hotspot.

4.3.1 SP&D Criteria #1: Natural Resources Inventory

Prior to the start of any land disturbing activities, including any clearing and grading activities, acceptable site reconnaissance and surveying techniques should be used to complete a thorough assessment of the natural resources, both terrestrial and aquatic, found on a development site. The natural resources inventory should be used to identify and map the natural resources listed in Table 4.2, as they exist prior to the start of any land disturbing activities.

The identification, and subsequent preservation and/or restoration of these natural resources, through the use of green infrastructure practices (SP&D Criteria #2), helps reduce the negative impacts of the land development process "by design."

Table 4.2: Resources to be Identified and Mapped During the Natural Resources Inventory	
Resource Group	Resource Type
General Resources	<ul style="list-style-type: none"> • Topography • Natural Drainage Divides • Natural Drainage Patterns • Natural Drainage Features (e.g., Swales, Basins, Depressional Areas) • Soils • Erodible Soils • Steep Slopes (i.e., Areas with Slopes Greater Than 15%) • Trees and Other Existing Vegetation
Freshwater Resources	<ul style="list-style-type: none"> • Rivers • Perennial and Intermittent Streams • Freshwater Wetlands
Estuarine Resources	<ul style="list-style-type: none"> • Tidal Rivers and Streams • Tidal Creeks • Coastal Marshlands • Tidal Flats • Scrub-Shrub Wetlands
Marine Resources	<ul style="list-style-type: none"> • Near Coastal Waters • Beaches
Groundwater Resources	<ul style="list-style-type: none"> • Groundwater Recharge Areas • Wellhead Protection Areas
Terrestrial Resources	<ul style="list-style-type: none"> • Dunes • Maritime Forests • Marsh Hammocks • Evergreen Hammocks • Canebrakes • Bottomland Hardwood Forests • Beech-Magnolia Forests • Pine Flatwoods • Longleaf Pine-Wiregrass Savannas • Longleaf Pine-Scrub Oak Woodlands
Other Resources	<ul style="list-style-type: none"> • Shellfish Harvesting Areas • Floodplains • Aquatic Buffers • Other High Priority Habitat Areas

The map that is created to illustrate the results of the natural resources inventory, known as a *site fingerprint*, should be used to prepare a stormwater management concept plan (SP&D Criteria #3) for the proposed development project.

4.3.2 SP&D Criteria #2: Use of Green Infrastructure Practices

Green infrastructure practices should be used to the *maximum extent practical* during the creation of a stormwater management concept plan (SP&D Criteria #3) for a proposed development project. Although the term *green infrastructure* can mean different things to different people (Box 4.1), in this CSS, the term *green infrastructure practices* has been succinctly defined as the combination of three complementary, but distinct, groups of natural resource protection and stormwater management practices and techniques:

Box 4.1: Green Infrastructure

Green infrastructure is a term that has been appearing more and more frequently in watershed and stormwater management discussions across coastal Georgia and the rest of the United States. The term, however, can mean different things to different people, depending on how it is used. Some use the term green infrastructure to refer to natural areas that provide ecological benefits in urban areas, while others use the term to refer to post-construction stormwater management practices that are designed to be “green” rather than “gray.”

In its broadest and, perhaps, truest sense, the term green infrastructure refers to an interconnected network of undisturbed natural areas and open space that helps preserve the ecological function of our watersheds (Benedict and McMahon, 2006). This interconnected network of aquatic and terrestrial resources (Figure 4.1) supports a wide range of resident and migratory organisms, maintains air and water quality and contributes greatly to a community’s natural beauty, economic well-being and quality of life.

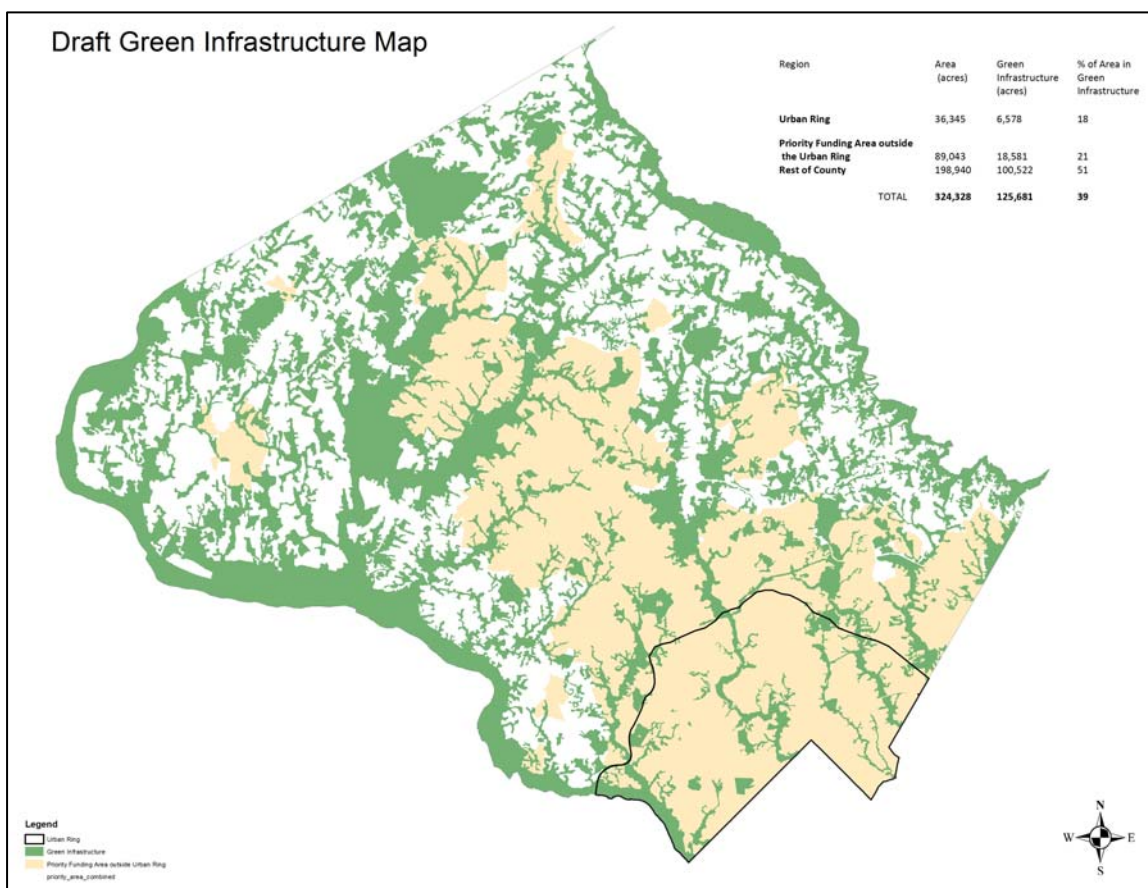

Figure 4.1: Green Infrastructure: An Interconnected Network of Undisturbed Natural Areas and Open Spaces
 (Source: Montgomery Co., MD Planning Department)

Many readers may have used the term green infrastructure to describe “greenspace” or “greenway” planning, which typically involves networks of human-oriented conservation areas and managed open spaces. True green infrastructure planning, however, looks beyond the anthropogenic value of these “greenspaces” and takes a more comprehensive approach to

Box 4.1: Green Infrastructure

preserving the ecology and functionality of our watersheds. In this respect, true green infrastructure planning requires a comprehensive, watershed-based approach to balancing land development and economic growth with the protection and/or restoration of our valuable natural resources. In other words, true green infrastructure planning requires an effort to identify and protect our aquatic and terrestrial resources from the impacts of the land development process before the process even begins.

Effective green infrastructure planning requires the support of federal, state and local policies, programs and regulations that encourage the use of innovative watershed and stormwater management techniques. The innovative techniques that can be found in this green infrastructure “toolbox” include: (1) using comprehensive land use planning and zoning to direct growth away from sensitive aquatic and terrestrial resources; (2) using land acquisition and better site planning techniques to protect and conserve valuable natural resources; (3) using better site design techniques to minimize land disturbance; and (4) using small-scale stormwater management practices to reduce post-construction stormwater runoff rates, volumes and pollutant loads. The last three “tools” in this green infrastructure “toolbox” are the *green infrastructure practices* detailed in this CSS.

- Better Site Planning Techniques: Techniques that are used to protect valuable aquatic and terrestrial resources from the direct impacts of the land development process.
- Better Site Design Techniques: Techniques that are used to minimize land disturbance and the creation of new impervious and disturbed pervious cover.
- Low Impact Development Practices: Small-scale stormwater management practices that are used to disconnect impervious and disturbed pervious surfaces from the storm drain system and reduce post-construction stormwater runoff rates, volumes and pollutant loads.

Together, these *green infrastructure practices* can be used to not only help protect coastal Georgia’s valuable terrestrial and aquatic resources from the direct impacts of the land development process, but also help maintain pre-development site hydrology and reduce post-construction stormwater runoff rates, volumes and pollutant loads. They also provide a number of other environmental and economic benefits, including (US EPA, 2008):

- Reduced Sanitary and Combined Sewer Overflow Events: By reducing stormwater runoff rates and volumes, green infrastructure practices help reduce the magnitude and frequency of combined and sanitary sewer overflow events.
- Urban Heat Island Mitigation: The trees, shrubs and other vegetation associated with green infrastructure practices create shade, reflect solar radiation and emit water vapor, all of which create cooler temperatures in urban environments and help mitigate the impacts of urban heat islands.
- Reduced Energy Demand: The trees, shrubs and other vegetation associated with green infrastructure practices help lower ambient air temperatures in urban areas and, when incorporated on and around buildings, help insulate buildings from temperature swings, decreasing the amount of energy used for heating and cooling.

- Improved Air Quality: The trees, shrubs and other vegetation associated with green infrastructure practices improve air quality by removing many airborne pollutants from the atmosphere through the processes of leaf uptake and contact removal.
- Increased Carbon Sequestration: The trees, shrubs and other vegetation associated with green infrastructure practices are able to capture and remove carbon from the atmosphere through the processes of photosynthesis and respiration.
- Improved Aesthetics: The trees, shrubs and other vegetation associated with green infrastructure practices improve aesthetics, provide recreational opportunities and wildlife habitat and increase property values (MacMullan and Reich, 2007, US EPA, 2007, Winer-Skonovd et al., 2006).
- Improved Human Health: An increasing number of studies suggest that the trees, shrubs and other vegetation associated with green infrastructure practices can have a positive impact on human health. Recent research has linked the presence of trees, plants and other vegetation to reduced levels of crime and violence, a stronger sense of community, improved academic performance and even reductions in the symptoms associated with attention deficit and hyperactivity disorders (Faber-Taylor and Kuo, 2006, Kuo, 2003, Sullivan et al., 2003, Kuo and Sullivan, 2001, Taylor et al., 1998).

These other environmental and economic benefits are particularly valuable in urban and suburban areas where green space and undisturbed natural areas may be few and far between.

In order to satisfy this criteria, it is *recommended* that:

- (1) Better site planning techniques be used to protect the following primary conservation areas (Table 4.3), which provide habitat for high priority plant and animal species (Appendix A) and are considered to be high priority habitat areas (WRD, 2005), from the direct impacts of the land development process.

Resource Group	Resource Type
Aquatic Resources	<ul style="list-style-type: none"> • Rivers • Perennial and Intermittent Streams • Freshwater Wetlands • Tidal Rivers and Streams • Tidal Creeks • Coastal Marshlands • Tidal Flats • Scrub-Shrub Wetlands • Near Coastal Waters • Beaches
Terrestrial Resources	<ul style="list-style-type: none"> • Dunes • Maritime Forests • Marsh Hammocks • Evergreen Hammocks • Canebrakes • Bottomland Hardwood Forests • Beech-Magnolia Forests • Pine Flatwoods • Longleaf Pine-Wiregrass Savannas • Longleaf Pine-Scrub Oak Woodlands

Table 4.3: Primary Conservation Areas

Resource Group	Resource Type
Other Resources	<ul style="list-style-type: none"> • Shellfish Harvesting Areas • Aquatic Buffers • Other High Priority Habitat Areas

- (2) Consideration be given to using better site planning techniques to protect the following secondary conservation areas (Table 4.4), from the direct impacts of the land development process.

Table 4.4: Secondary Conservation Areas

Resource Group	Resource Type
General Resources	<ul style="list-style-type: none"> • Natural Drainage Features (e.g., Swales, Basins, Depressional Areas) • Erodible Soils • Steep Slopes (i.e., Areas with Slopes Greater Than 15%) • Trees and Other Existing Vegetation
Aquatic Resources	<ul style="list-style-type: none"> • Groundwater Recharge Areas • Wellhead Protection Areas
Other Resources	<ul style="list-style-type: none"> • Floodplains

- (3) Consideration be given to using better site design techniques to minimize land disturbance and limit the creation of new impervious and disturbed pervious cover.
- (4) Low-impact development practices be used, to the *maximum extent practical*, to reduce post-construction stormwater runoff rates, volumes and pollutant loads, and help satisfy the post-construction stormwater management criteria presented in this CSS (Section 4.4).

4.3.3 SP&D Criteria #3: Stormwater Management Concept Plan

A stormwater management concept plan should be prepared for all proposed development projects. The stormwater management concept plan should be created using the results of the natural resources inventory (SP&D Criteria #1). It should illustrate the layout of the proposed development project and should show, in general, how post-construction stormwater runoff will be managed on the development site.

It is *recommended* that the stormwater management concept plan include the following information:

- Project narrative, which includes:
 - Common address of site
 - Legal description of site
 - Vicinity map
- *Site fingerprint*, which illustrates the results of the natural resources inventory (SP&D Criteria #1)
- Existing conditions map, which includes all of the information shown on the *site fingerprint*, plus:
 - Existing roads, buildings, parking areas and other impervious surfaces
 - Existing utilities (e.g., water, sewer, gas, electric) and utility easements
 - Existing primary and secondary conservation areas
 - Existing low impact development and stormwater management practices
 - Existing storm drain infrastructure (e.g., inlets, manholes, storm drains)

- Existing channel modifications (e.g., bridge or culvert installations)
- Proposed conditions map, which includes:
 - Proposed topography (minimum two-foot contours recommended)
 - Proposed drainage divides and patterns
 - Proposed roads, buildings, parking areas and other impervious surfaces
 - Proposed utilities (e.g., water, sewer, gas, electric) and utility easements
 - Proposed limits of clearing and grading
 - Proposed primary and secondary conservation areas
 - Proposed low impact development and stormwater management practices
 - Proposed storm drain infrastructure (e.g., inlets, manholes, storm drains)
 - Proposed channel modifications (e.g., bridge or culvert installations)
- Post-construction stormwater management system narrative, which includes:
 - Information about how post-construction stormwater runoff will be managed on the development site, including a list of the low impact development and stormwater management practices that will be used
 - Calculations showing how initial estimates of the post-construction stormwater management criteria that apply to the development project were obtained, including information about the existing and proposed conditions of each of the drainage areas found on the development site (e.g., size, soil types, land cover characteristics)
- List of expected waiver requests

The stormwater management concept plan should be submitted to the local development review authority prior to the preparation and submittal of a stormwater management design plan (SP&D Criteria #4).

4.3.4 SP&D Criteria #4: Stormwater Management Design Plan

A stormwater management design plan should be prepared for all proposed development projects. The stormwater management design plan should detail how post-construction stormwater runoff will be managed on the development site and should include maps, narrative descriptions and design calculations (e.g., hydrologic and hydraulic calculations) that show how the stormwater management and site planning and design criteria that apply to the development project have been met.

It is *recommended* that the stormwater management design plan include all of the information included in the stormwater management concept plan (SP&D Criteria #3), plus:

- Existing conditions hydrologic analysis, which includes:
 - Existing conditions map
 - Information about the existing conditions of each of the drainage areas found on the development site (e.g., size, soil types, land cover characteristics)
 - Information about the existing conditions of any off-site drainage areas that contribute stormwater runoff to the development site (e.g., size, soil types, land cover characteristics)
 - Information about the stormwater runoff rates and volumes generated, under existing conditions, in each of the drainage areas found on the development site
 - Information about the stormwater runoff rates and volumes generated, under existing conditions, in each of the off-site drainage areas that contribute stormwater runoff to the development site
 - Documentation (e.g., model diagram) and calculations showing how the existing conditions hydrologic analysis was completed

- Proposed conditions hydrologic analysis, which includes:
 - Proposed conditions map
 - Information about the proposed conditions of each of the drainage areas found on the development site (e.g., size, soil types, land cover characteristics)
 - Information about the proposed conditions of any off-site drainage areas that contribute stormwater runoff to the development site (e.g., size, soil types, land cover characteristics)
 - Information about the stormwater runoff rates and volumes generated, under proposed conditions, in each of the drainage areas found on the development site
 - Information about the stormwater runoff rates and volumes generated, under proposed conditions, in each of the off-site drainage areas that contribute stormwater runoff to the development site
 - Documentation (e.g., model diagram) and calculations showing how the proposed conditions hydrologic analysis was completed
- Post-construction stormwater management system plan, which includes:
 - Proposed topography
 - Proposed drainage divides and patterns
 - Existing and proposed roads, buildings, parking areas and other impervious surfaces
 - Existing and proposed primary and secondary conservation areas
 - Plan view of existing and proposed low impact development and stormwater management practices
 - Cross-section and profile views of existing and proposed low impact development and stormwater management practices, including information about water surface elevations, storage volumes and inlet and outlet structures (e.g., orifice sizes)
 - Plan view of existing and proposed storm drain infrastructure (e.g., inlets, manholes, storm drains)
 - Cross-section and profile views of existing and proposed storm drain infrastructure (e.g., inlets, manholes, storm drains), including information about invert and water surface elevations
 - Existing and proposed channel modifications (e.g., bridge or culvert installations)
- Post-construction stormwater management system narrative, which includes:
 - Information about how post-construction stormwater runoff will be managed on the development site, including a list of the low impact development and stormwater management practices that will be used
 - Documentation and calculations that demonstrate how the selected low impact development and stormwater management practices satisfy the post-construction stormwater management criteria that apply to the development site, including information about the existing and proposed conditions of each of the drainage areas found on the development site (e.g., size, soil types, land cover characteristics)
 - Hydrologic and hydraulic analysis of the post-construction stormwater management system for all applicable design storms, which should include stage-storage or outlet rating curves and inflow and outflow hydrographs.

The stormwater management design plan should be submitted to the local development review authority for review and approval.

A copy of the stormwater management concept plan (SP&D Criteria #3) should be included with the submittal of the stormwater management design plan. The stormwater management

design plan should be consistent with the stormwater management concept plan. If any significant changes were made to the development plan, the local development review authority may ask for a written statement providing rationale for any of the changes that were made.

4.3.5 SP&D Criteria #5: Downstream Analysis

Although the overbank flood protection criteria (SWM Criteria #4) and extreme flood protection criteria (SWM Criteria #5) have been designed to help prevent an increase the frequency, duration and severity of damaging flooding events, occasionally, due to the timing and duration of discharges from development sites, they do not always accomplish this goal. Consequently, it is *recommended* that a downstream analysis be performed to identify any additional overbank or extreme flooding that may result from an increase in stormwater runoff rates and volumes on a development site. The analysis should be performed at the discharge point(s) of the development site and at each junction in the downstream conveyance system where the portion of the development site draining to that point is greater than or equal to ten percent of the total area contributing drainage to that same point. If the results of the downstream analysis show that there will be increased overbank or extreme flooding due to the proposed development project, additional control of post-construction stormwater runoff may need to be provided on the development site. Additional guidance on performing a downstream analysis is provided in Section 2.9.1 of Volume 2 of the *Georgia Stormwater Management Manual* (ARC, 2001).

The results of the downstream analysis should be included with the submittal of the stormwater management design plan (SP&D Criteria #4).

4.3.6 SP&D Criteria #6: Stormwater Management System Inspection and Maintenance Plan

In order to help ensure that they will continue to function as designed over time, it is *recommended* that comprehensive inspection and maintenance plans be developed for all post-construction stormwater management systems. All stormwater management system inspection and maintenance plans should outline the routine inspection and maintenance tasks that will be completed on all components of the post-construction stormwater management system, including: (1) green infrastructure practices; (2) stormwater management practices; (3) stormwater conveyance features; and (4) storm drain infrastructure. Consequently, it is *recommended* that all stormwater management system inspection and maintenance plans include the following information:

- Timeline indicating, in general, when routine inspection and maintenance activities will occur
- Name of the person or party responsible for completing routine inspection and maintenance activities
- Signed statement confirming that responsibility for the inspection and maintenance of the post-construction stormwater management system, unless assumed by the local development review authority, will remain with the property owner
- Signed statement confirming that, if portions of the property are sold or otherwise transferred, arrangements will be made to pass the inspection and maintenance responsibilities to the successive owners
- Signed statement providing the local development review authority with permission to enter the property, at reasonable times and in a reasonable manner, and inspect the post-construction stormwater management system

The stormwater management system inspection maintenance and plan should be included with the submittal of the stormwater management design plan (SP&D Criteria #4).

4.3.7 SP&D Criteria #7: Erosion and Sediment Control Plan

An erosion and sediment control plan should be prepared for all proposed development projects. All erosion and sediment control plans should be prepared in accordance with requirements of the *Georgia Erosion and Sediment Control Act* (O.C.G.A. §12-7-1 through §12-7-22) and the State's National Pollutant Discharge Elimination System (NPDES) General Permit for Stormwater Discharges Associated with Construction Activities, and should include erosion and sediment control practices, such as those detailed in the *Manual for Erosion and Sediment Control in Georgia* (GSWCC, 2000), that will help minimize the negative impacts of construction stormwater runoff on coastal Georgia's valuable aquatic and terrestrial resources. Additional guidance on preparing an erosion and sediment control plan and on the use of erosion and sediment control practices is provided in the *Manual for Erosion and Sediment Control in Georgia* (GSWCC, 2000) and *Developing Your Stormwater Pollution Prevention Plan: A Guide for Construction Sites* (US EPA, 2007).

The erosion and sediment control plan should be included with the submittal of the stormwater management design plan (SP&D Criteria #4).

4.3.8 SP&D Criteria #8: Landscaping Plan

A landscaping plan should be prepared for all proposed development projects. All landscaping plans should illustrate the layout of the proposed development project and should identify any landscaping features that will be installed on the development site. Consequently, it is *recommended* that all landscaping plans include the following information:

- Existing trees and other vegetation
- Existing and proposed roads, buildings, parking areas and other impervious surfaces
- Existing and proposed primary and secondary conservation areas (e.g., aquatic buffers, trees and other existing vegetation)
- Proposed limits of clearing and grading
- Existing and proposed low impact development and stormwater management practices
- Other landscaping features and areas
- Proposed plantings
- Information about the landscaping methods and materials that will be used during construction

The landscaping plan should be included with the submittal of the stormwater management design plan (SP&D Criteria #4).

4.3.9 SP&D Criteria #9: Stormwater Pollution Prevention Plan

A stormwater pollution prevention plan should be developed for all proposed development projects involving the creation or modification of a stormwater hotspot. To help minimize the acute negative impacts that these development projects can have on the aquatic and terrestrial resources of coastal Georgia, it is *recommended* that appropriate pollution prevention practices be used to the *maximum extent practical* during the creation of a stormwater pollution prevention plan. Additional guidance on developing a stormwater pollution prevention plan and on the use of pollution prevention practices is provided in the *Municipal Stormwater*

Best Management Practice Handbook (CASQA, 2003) and the *Pollution Source Control Practices Manual* (Schueler et al., 2005).

The stormwater pollution prevention plan should be included with the submittal of the stormwater management design plan (SP&D Criteria #4).

4.4 Post-Construction Stormwater Management Criteria

It is *recommended* that the following post-construction stormwater management criteria (SWM Criteria) be applied to any new development or redevelopment activity that meets one or more of the applicability criteria listed above (Section 4.2). These SWM Criteria help translate the integrated approach to natural resource protection, stormwater management and site design detailed in this CSS into a set of quantitative criteria that can be used to design a post-construction stormwater management system on a development site. These SWM Criteria are briefly summarized in Table 4.5 below.

Criteria	Description
SWM Criteria #1: Stormwater Runoff Reduction	Reduce the stormwater runoff volume generated by the 85 th percentile storm event (and the "first flush" of the stormwater runoff volume generated by all larger storm events) on a development site through the use of appropriate green infrastructure practices. In coastal Georgia, this equates to reducing the stormwater runoff volume generated by the 1.2 inch rainfall event (and the stormwater runoff generated by the first 1.2 inches of all larger rainfall events).
SWM Criteria #2: Stormwater Quality Protection	Adequately treat post-construction stormwater runoff before it is discharged from a development site. In coastal Georgia, this criteria can be satisfied simply by satisfying the stormwater runoff reduction criteria (SWM Criteria #1). However, if any of the stormwater runoff generated by the 1.2 inch storm event (and the first 1.2 inches of all larger rainfall events), cannot be <i>reduced</i> on a development site, due to site characteristics or constraints, it should be <i>intercepted and treated</i> in one or more stormwater management practices that: (1) provide for at least an 80 percent reduction in TSS loads; and (2) reduce nitrogen and bacteria loads to the <i>maximum extent practical</i> .
SWM Criteria #3: Aquatic Resource Protection	Protect coastal Georgia's valuable aquatic resources from several other negative impacts of the land development process (e.g., complete loss or destruction, stream channel enlargement, increased salinity fluctuations) by: (1) protecting them from the direct impacts of the land development process through the use of better site planning techniques; (2) establishing a minimum 25-foot wide aquatic buffer around them (although a 75-foot wide aquatic buffer is preferred); (3) providing 24 hours of extended detention for the stormwater runoff volume generated by the 1-year, 24-hour storm event before it is discharged from a development site; and (4) providing velocity control and energy dissipation measures at all new and existing stormwater outfalls.
SWM Criteria #4: Overbank Flood Protection	Prevent an increase in the duration, frequency and magnitude of damaging overbank flooding by controlling (attenuating) the peak discharge generated by the 25-year, 24-hour storm event under post-development conditions.

Table 4.5: Summary of the Post-Construction Stormwater Management Criteria

Criteria	Description
SWM Criteria #5: Extreme Flood Protection	Prevent an increase in the duration, frequency and magnitude of dangerous extreme flooding by controlling (attenuating) the peak discharge generated by the 100-year, 24-hour storm event under post-development conditions.

4.4.1 SWM Criteria #1: Stormwater Runoff Reduction

An analysis of historical rainfall data shows that small, frequent storm events account for a majority of the storm events that occur in the Coastal Nonpoint Source Management Area and Area of Special Interest (Appendix B). Consequently, these small, but frequent storm events also account for a majority of the stormwater runoff volumes (and pollutant loads) that are generated on development sites. By reducing the stormwater runoff generated by these small, but frequent, storm events, it is possible to help maintain pre-development site hydrology and help protect coastal Georgia's aquatic resources from several indirect impacts of the land development process (i.e., decreased groundwater recharge, decreased baseflow, degraded water quality). Therefore, it is *recommended* that the stormwater runoff volume generated by the 85th percentile storm event (and the "first flush" of the stormwater runoff generated by all larger storm events) be *reduced* on a development site through the use of appropriate green infrastructure practices.

In coastal Georgia, reducing the stormwater runoff volume generated by the 85th percentile storm event equates to reducing the stormwater runoff volume generated by the 1.2 inch rainfall event (and the stormwater runoff generated by the first 1.2 inches of all larger rainfall events). The correlation between the 85th percentile storm event and the 1.2 inch storm event was derived from an analysis of historical rainfall data from the communities of Brooklet, Brunswick, Douglas, Folkston, Jesup and Savannah (Appendix B) and is considered to be an average value for the entire Coastal Nonpoint Source Management Area and Area of Special Interest.

Based on some simple hydrologic modeling, and the results of several other studies investigating the hydrology of the Atlantic coastal plain, the volume of stormwater runoff generated by the 1.2 inch storm event was deemed to be a reasonable initial target for stormwater runoff reduction in coastal Georgia. Hydrologic modeling conducted using the Simple Method (Schueler, 1987) shows that only about five percent of the annual rainfall that falls on an undeveloped site can be expected to be converted to stormwater runoff (Box 4.2). The remaining 95 percent can be expected to be "lost", primarily through the hydrologic processes of infiltration and evapotranspiration.

Although these results are based on some simple hydrologic modeling, other researchers (DeBusk 2008, Holland and Sanger, 2008,) have drawn similar conclusions about the hydrology of undeveloped sites located within the Atlantic coastal plain. Their studies have concluded that, depending on site characteristics (e.g., land cover, soils, hydrologic condition), somewhere between two and twenty percent of the annual rainfall that falls on an undeveloped site can be expected to be converted to stormwater runoff. The remainder of the annual rainfall can be expected to be "lost" to hydrologic processes of infiltration and evapotranspiration.

Box 4.2: Hydrologic Modeling of Pre-Development Conditions Using the Simple Method

Figure 4.2: Bay Street Community Center, Savannah, GA
(Source: Atlanta Regional Commission, 2001)

Site Data

Site Area, $A = 3.0$ acres

Pre-Development Impervious Area = 0.0 acres

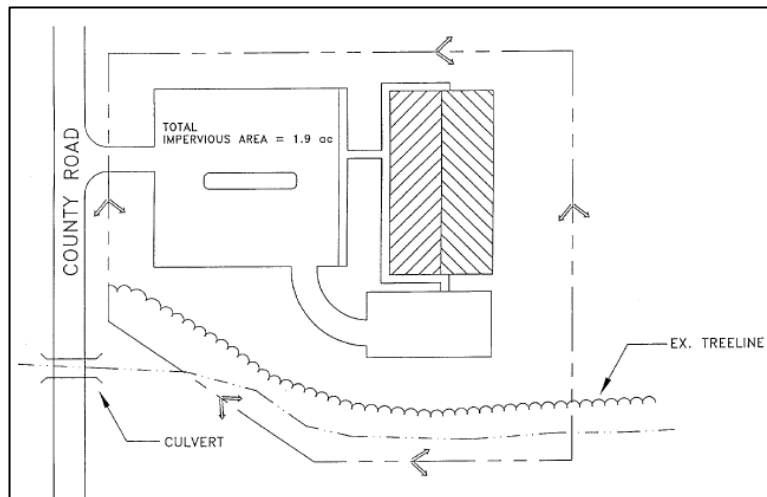
Post-Development Impervious Area = 1.9 acres

Soils = Hydrologic Soil Group "B" Soils

Hydrologic Data

Annual Rainfall, $P = 49.58$ inches (NOAA, 2008)

Pre-Development Site Imperviousness, $I_{pre} = 0.0 \div 3.0 = 0.0\%$

Post-Development Site Imperviousness, $I_{post} = 1.9 \div 3.0 = 63.3\%$

(1) Compute Potential Annual Stormwater Runoff Volume

Potential Runoff Volume = $(P)(A) \div 12$

Potential Runoff Volume = $(49.58 \text{ in})(3.0 \text{ ac}) \div 12 \text{ in/ft}$

Potential Runoff Volume = 12.40 ac-ft

(2) Compute Pre-Development Volumetric Runoff Coefficient, R_{v-pre}

$R_{v-pre} = 0.05 + 0.009(I_{pre})$

$R_{v-pre} = 0.05 + 0.009(0.0) = 0.05$

(3) Compute Actual Annual Stormwater Runoff Volume

Actual Runoff Volume = $(P)(R_{v-pre})(A) \div 12$

Actual Runoff Volume = $(49.58 \text{ in})(0.05)(3.0 \text{ ac}) \div 12 \text{ in/ft}$

Actual Runoff Volume = 0.62 ac-ft

(4) Confirm Ratio of Actual Runoff Volume to Potential Runoff Volume

$(0.62 \text{ ac-ft}) \div (12.40 \text{ ac-ft}) = 0.05$ OR 5%

Since the 1.2 inch storm event (and the first 1.2 inches of all larger storm events) is responsible for generating nearly 83 percent of the total rainfall that occurs in coastal Georgia (Appendix B),

reducing the stormwater runoff generated by the 85th percentile storm event (and the “first flush” of the stormwater runoff generated by all larger storm events) can be expected to reduce annual post-construction stormwater runoff volumes (and pollutant loads) by nearly 83 percent as well. In the end, only about 17 percent of the total rainfall that falls on a development site will be converted to stormwater runoff; the remaining 83 percent will be “lost” through green infrastructure practices that provide for the interception, evapotranspiration, infiltration or capture and reuse of stormwater runoff.

Although targeting a larger rainfall event (e.g., 1.5 inch, 2 inch) for stormwater runoff reduction would provide further reductions in post-construction stormwater runoff volumes (and pollutant loads), it would also increase the size, cost and complexity of the green infrastructure practices that would need to be used on development sites. On the other hand, targeting a smaller rainfall event (e.g., 0.5 inch) would not provide enough stormwater runoff reduction to meaningfully preserve pre-development hydrologic conditions or adequately protect stormwater quality throughout Georgia’s 24-county coastal region.

The amount of stormwater runoff reduction needed to satisfy this criteria, which is known as the runoff reduction volume (RR_v) (Section 5.2), may be reduced on development sites that are considered to be stormwater hotspots or that have site characteristics or constraints (e.g., high groundwater, impermeable soils, contaminated soils, confined groundwater aquifer recharge areas) that prevent the use of green infrastructure practices that provide for the interception, evapotranspiration, infiltration or capture and reuse of stormwater runoff. When seeking reduction in the amount of stormwater runoff reduction that needs to be provided in order to satisfy this criteria, it is *recommended* that:

- (1) Appropriate green infrastructure practices be used to reduce, *at a minimum*, the stormwater runoff volume generated by the 0.6 inch rainfall event (and the first 0.6 inches of all larger rainfall events) on the development site.
- (2) Adequate documentation be provided to the local development review authority to show that no additional runoff reducing green infrastructure practices can be used on the development site.

Any of the stormwater runoff generated by the 1.2 inch storm event (and the first 1.2 inches of all larger rainfall events) that is not *reduced* on the development site should be *intercepted and treated* in one or more stormwater management practices that provide at least an 80 percent reduction in total suspended solids loads and that reduce nitrogen and bacteria loads to the *maximum extent practical* (SWM Criteria #2).

4.4.2 SWM Criteria #2: Stormwater Quality Protection

In order to protect coastal Georgia’s aquatic resources from water quality degradation, it is *recommended* that stormwater runoff be adequately treated before it is discharged from a development site. In accordance with the Guidance Specifying Management Measures for Sources of Nonpoint Source Pollution in Coastal Waters (US EPA, 1993), this means reducing the total suspended solids (TSS) loads contained in post-construction stormwater runoff by at least 80 percent, as measured on an average annual basis.

Although providing an 80 percent reduction in TSS loads can be assumed to provide adequate removal of a number of common stormwater pollutants (e.g., phosphorus, metals) (US EPA, 1993), it can not be assumed to provide sufficient removal of either nitrogen or bacteria, which, along with TSS, should be considered to be the primary pollutants of concern in coastal Georgia

(Novotney, 2007). In order to help minimize the negative impacts that these two other pollutants of concern can have on coastal Georgia's valuable estuarine and marine resources (e.g., shellfish bed contamination and closure, beach contamination, increased primary productivity, reduced dissolved oxygen levels), it is *recommended* that the nitrogen and bacteria loads contained in post-construction stormwater runoff be reduced to the *maximum extent practical* on development sites.

Since reducing the stormwater runoff volume generated by the 85th percentile storm event (and the "first flush" of the stormwater runoff generated by all larger storm events) can be expected to reduce annual post-construction stormwater runoff volumes (and pollutant loads) by more than 80 percent on development sites, this stormwater quality protection criteria can be satisfied simply by satisfying the stormwater runoff reduction criteria (SWM Criteria #1). However, if any of the stormwater runoff volume generated by the 1.2 inch storm event, cannot be *reduced* on a development site, due to site characteristics or constraints, it should be *intercepted and treated* in one or more stormwater management practices that: (1) provide for at least an 80 percent reduction in TSS loads; and (2) reduce nitrogen and bacteria loads to the *maximum extent practical*. Adequate documentation should be provided to the local development review authority to show that total TSS, nitrogen and bacteria removal were considered during the selection of the stormwater management practices that will be used to *intercept and treat* stormwater runoff on the development site.

4.4.3 SWM Criteria #3: Aquatic Resource Protection

In order to protect coastal Georgia's valuable aquatic resources from several other negative impacts of the land development process (i.e., complete loss or destruction, stream channel enlargement, increased salinity fluctuations), it is *recommended* that:

- (1) The following aquatic resources be identified as primary conservation areas and protected from the direct impacts of the land development process through the use of better site planning techniques:
 - o Rivers
 - o Perennial and Intermittent Streams
 - o Freshwater Wetlands
 - o Tidal Rivers and Streams
 - o Tidal Creeks
 - o Coastal Marshlands
 - o Tidal Flats
 - o Scrub-Shrub Wetlands
 - o Near Coastal Waters
 - o Beaches

- (2) Although a 75-foot wide aquatic buffer is preferred (Rowe et al., 2007, Franzen et al., 2006), a minimum 25-foot wide aquatic buffer, as measured horizontally from the point where vegetation has been wrested by normal stream flow or wave action, be established (Box 4.3) around all of the aquatic resources listed above. Aquatic buffers not only provide streams, wetlands and other aquatic resources with protection against the direct impacts of the land development process, but also help protect adjacent properties from flooding during storm events. All aquatic buffers should be identified as primary conservation areas and protected from the direct impacts of the land development process through the use of better site planning techniques.

- (3) 24 hours of extended detention be provided for the stormwater runoff volume generated by the 1-year, 24-hour storm event before it is discharged from a development site. Providing the storage needed to provide 24 hours of extended detention for the stormwater runoff volume generated by the 1-year, 24-hour storm event, which is known as the aquatic resource protection volume (ARP_v) (Section 5.3), will not only help control streambank erosion in coastal Georgia's freshwater rivers and streams (by reducing the frequency and duration of channel forming bankfull and near bankfull events), but will also help control the harmful salinity fluctuations that occur in the region's tidal creeks, coastal marshlands and other vital estuarine resources.
- (4) Velocity control and energy dissipation measures be installed at all new and existing stormwater outfalls. Implementing these erosion control practices will help prevent localized erosion in coastal Georgia's freshwater, estuarine and marine resources. Additional information on the use of velocity control and energy dissipation measures is provided in Section 4.5 of Volume 2 of the *Georgia Stormwater Management Manual* (ARC, 2001).

Box 4.3: Establishing an Aquatic Buffer

An aquatic buffer is an undisturbed natural area located immediately adjacent to a river, stream, tidal creek, coastal marshland or other aquatic resource where land disturbing activities are significantly restricted or prohibited. While they function primarily to preserve the integrity of streams, wetlands and other aquatic resources, and protect them from the direct impacts of the land development process, they also provide a number of other important ecological services, including pollutant removal, erosion control and flood attenuation.

Although a 75-foot wide aquatic buffer is preferred (Rowe et al., 2007, Franzen et al., 2006), a minimum 25-foot wide aquatic buffer, as measured horizontally from the point where vegetation has been wrested by normal stream flow or wave action, should be established around all of coastal Georgia's aquatic resources. Aquatic buffers can be of fixed or variable width, but should be continuous and should not be interrupted by impervious surfaces or bypassed with stormwater outfalls that discharge post-construction stormwater runoff directly into the stream, wetland or other aquatic resource being protected by the buffer. Where aquatic buffers have been significantly altered by clearing, grading and other land disturbing activities, or where they consist exclusively of managed turf, reforestation or revegetation is recommended (Section 7.8.2).

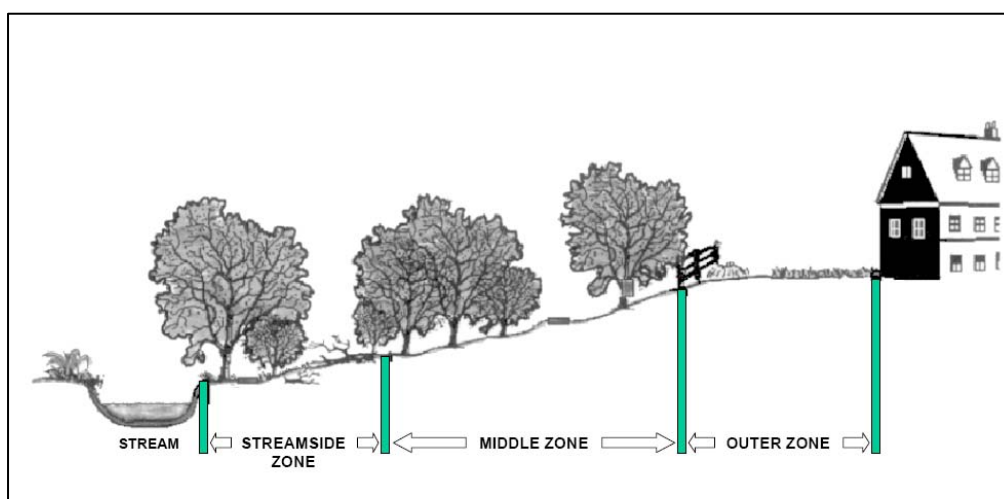

Figure 4.3: Multi-Zone Aquatic Buffer System
(Source: Center for Watershed Protection, 1998)

Box 4.3: Establishing an Aquatic Buffer

Even if site characteristics or constraints only permit the use of a 25-foot wide *undisturbed* aquatic buffer on a development site, additional "disturbed buffer zones" (Figure 4.3) can be added to extend the total width of the buffer to 75 feet. Although they do not provide the same environmental benefits as *undisturbed* aquatic buffers, these "disturbed buffer zones" provide site planning and design teams with additional flexibility during the site planning and design process. Each of these "disturbed buffer zones" are described in more detail in Table 4.6.

Table 4.6: Allowable Uses Associated with the Multi-Zone Aquatic Buffer System
(Source: CWP, 1998)

Characteristic	Undisturbed Streamside Zone	Middle Zone	Outer Zone
Width	Minimum 25 feet	Variable, depending on stream order, slope and extent of 100-year floodplain (Minimum 25 feet)	25 feet or less
Vegetation	Undisturbed native vegetation; reforest or revegetate if necessary	Managed native vegetation, some clearing allowed	Native vegetation encouraged; turf grass acceptable
Allowable Uses	Significantly Restricted (e.g., flood control, utility easements)	Restricted (e.g., some recreational use, bike paths)	Unrestricted (e.g., residential use, gardening)

4.4.4 SWM Criteria #4: Overbank Flood Protection

In order to prevent an increase in the duration, frequency and magnitude of downstream overbank flooding, it is *recommended* that enough stormwater detention be provided on a development site to ensure that the peak discharge generated by the 25-year, 24-hour storm event under post-development conditions, which is known as the overbank peak discharge (Q_{p25}) (Section 5.4), does not exceed the peak discharge generated by the same storm event under pre-development conditions. Satisfying this overbank flood protection criteria will help protect downstream properties from damaging overbank flooding events.

This criteria may be modified or waived on development sites where both the on-site and downstream stormwater conveyance systems are designed to safely convey the peak discharge generated by the 25-year, 24-hour storm event under post-development conditions to a receiving water without causing additional downstream flooding or other environmental impacts (e.g., stream channel enlargement, degradation of habitat).

It is important to note that satisfying this overbank flood protection criteria and the aquatic resource protection criteria (SWM Criteria #3) typically provides effective control of the peak discharges generated by all of the storm events that are smaller than the 25-year, 24-hour storm event and larger than the 1-year, 24-hour storm event (e.g., 2-year, 24-hour storm event, 10-year, 24-hour storm event). It is also important to note that satisfying this overbank flood protection criteria and the extreme flood protection criteria (SWM Criteria #5) will also help control the peak discharges generated by storm events that are larger than the 25-year, 24-hour storm event (e.g., 50-year, 24-hour storm event).

4.4.5 SWM Criteria #5: Extreme Flood Protection

In order to prevent an increase in the duration, frequency and magnitude of downstream extreme flooding, it is *recommended* that enough stormwater detention be provided on a development site to ensure that the peak discharge generated by the 100-year, 24-hour storm event under post-development conditions, which is known as the extreme peak discharge (Q_{p100}) (Section 5.5), does not exceed the peak discharge generated by the same storm event under pre-development conditions. Satisfying this extreme flood protection criteria will protect downstream properties from dangerous extreme flooding events and will help maintain the boundaries of the existing 100-year floodplain. It will also help protect public health and safety and the physical integrity of downstream stormwater conveyance features and management practices.

This criteria may be modified or waived on development sites where both the on-site and downstream stormwater conveyance systems are designed to safely convey the peak discharge generated by the 100-year, 24-hour storm event under post-development conditions to a receiving water without causing additional downstream flooding or other environmental impacts (e.g., stream channel enlargement, degradation of habitat). Other appropriate flood protection measures (e.g., levees, floodwalls, channel enlargements) may also be used to protect downstream properties from extreme flood events, as long as the measures do not have other negative environmental impacts (e.g., degradation of habitat).

4.5 Special Stormwater Management and Site Planning and Design Criteria

Because of the importance of shellfish harvesting areas to the economy of coastal Georgia and that of the entire state, and their enhanced sensitivity to the impacts of the land development process, it is *recommended* that several special stormwater management and site planning and design criteria (Special Criteria) be applied to new development and redevelopment activities taking place near these critical areas. Additional information about these Special Criteria is provided below.

4.5.1 Special Criteria for Shellfish Harvesting Areas

It is *recommended* that the following Special Criteria be applied to any new development or redevelopment activity located that is located within 1/2-mile of a shellfish harvesting area and that meets one or more of the applicability criteria listed above (Section 4.2).

4.5.1.1 Special Criteria #1: Increased Stormwater Runoff Reduction

In order to better protect shellfish harvesting areas from contamination and closure, it is *recommended* that the amount of stormwater runoff reduction needed to satisfy the stormwater runoff reduction criteria (SWM Criteria #1) be *increased* on development sites that are located within 1/2-mile of a shellfish harvesting area. On these development sites, the stormwater runoff volume generated by the 90th percentile storm event (and the "first flush" of the stormwater runoff generated by all larger storm events) should be *reduced* on site through the use of appropriate green infrastructure practices.

In coastal Georgia, reducing the stormwater runoff volume generated by the 90th percentile storm event equates to reducing the stormwater runoff volume generated by the 1.5 inch rainfall event (and the stormwater runoff generated by the first 1.5 inches of all larger rainfall events). The correlation between the 90th percentile storm event and the 1.5 inch storm event was derived from an analysis of historical rainfall data from the communities of Brooklet, Brunswick,

Douglas, Folkston, Jesup and Savannah (Appendix B) and is considered to be an average value for the entire Coastal Nonpoint Source Management Area and Area of Special Interest.

The amount of stormwater runoff reduction needed to satisfy this criteria may be reduced on development sites that have site characteristics or constraints (e.g., high groundwater, impermeable soils, contaminated soils, confined groundwater aquifer recharge areas) that prevent the use of green infrastructure practices that provide for the interception, evapotranspiration, infiltration or capture and reuse of stormwater runoff. When seeking reduction in the amount of stormwater runoff reduction that needs to be provided in order to satisfy this criteria, it is *recommended* that:

- (1) Appropriate green infrastructure practices be used to reduce, *at a minimum*, the stormwater runoff volume generated by the 0.75 inch rainfall event (and the first 0.75 inches of all larger rainfall events) on the development site.
- (2) Adequate documentation be provided to the local development review authority to show that no additional runoff reducing green infrastructure practices can be used on the development site.

Any of the stormwater runoff generated by the 1.5 inch storm event (and the first 1.5 inches of all larger rainfall events) that is not *reduced* on the development site should be *intercepted and treated* in one or more stormwater management practices that provide at least an 80 percent reduction in total suspended solids loads and that reduce nitrogen and bacteria loads to the *maximum extent practical* (SWM Criteria #2). Adequate documentation should be provided to the local development review authority to show that nitrogen and bacteria removal were considered during the selection of the stormwater management practices used to *intercept and treat* stormwater runoff on the development site.

4.5.1.2 Special Criteria #2: Enhanced Aquatic Resource Protection

In order to better protect them from contamination and closure, it is also *recommended* that the minimum buffer width needed to satisfy the aquatic resource protection criteria (SWM Criteria #3) be *increased* on development sites that are located within 1/2-mile of shellfish harvesting areas. On these development sites, although a 75-foot wide aquatic buffer is preferred (Rowe et al., 2007, Franzen et al., 2006), a minimum 50-foot wide aquatic buffer, as measured horizontally from the point where vegetation has been wrested by normal stream flow or wave action, should be established around all aquatic resources considered to be primary conservation areas (Section 4.4.3). All aquatic buffers should themselves be identified as primary conservation areas and protected from the direct impacts of the land development process through the use of better site planning techniques.

4.6 Summary

The post-construction stormwater management and site planning and design criteria presented above provide the foundation for the integrated, green infrastructure-based approach to natural resource protection, stormwater management and site design detailed in this CSS. As shown in Table 4.7, when applied in combination with one another, they can be used to address nearly all of the negative impacts that the land development process can have on coastal Georgia's valuable terrestrial and aquatic resources.

The remainder of this CSS provides information about satisfying these stormwater management and site planning and design criteria, beginning with information about using accepted

hydrologic methods to calculate the stormwater runoff volumes associated with the post-construction stormwater management criteria that apply to a development site. These calculations can be used to plan and design a post-construction stormwater management system that will help protect coastal Georgia's valuable natural resources from the negative impacts of land development and nonpoint source pollution.

Table 4.7: How the Criteria Help Address the Negative Impacts of the Land Development Process

Criteria	How It Helps Address the Negative Impacts of the Land Development Process
Site Planning and Design Criteria	
SP&D Criteria #1: Natural Resources Inventory	Identifying the natural resources found on a development site prior to the start of any land disturbing activities decreases the likelihood of any valuable natural resources being completely lost or destroyed during the land development process.
SP&D Criteria #2: Use of Green Infrastructure Practices	Using green infrastructure practices to protect valuable natural resources, maintain pre-development site hydrology and reduce post-construction stormwater runoff rates, volumes and pollutant loads, helps preserve the ecological function of our watersheds.
SP&D Criteria #3: Stormwater Management Concept Plan	Developing a stormwater management concept plan helps ensure that natural resource protection and stormwater management are integrated with the site planning and design process.
SP&D Criteria #4: Stormwater Management Design Plan	Developing a stormwater management design plan helps ensure that natural resource protection and stormwater management are integrated with the site planning and design process.
SP&D Criteria #5: Downstream Analysis	Conducting a downstream analysis helps protect against an increase in the duration, frequency and magnitude of overbank and extreme flooding events.
SP&D Criteria #6: Stormwater Management System Inspection and Maintenance Plan	Developing a stormwater management system inspection and maintenance plan helps ensure that green infrastructure and stormwater management practices will continue to control and minimize the negative impacts of the land development process over time.
SP&D Criteria #7: Erosion and Sediment Control Plan	Developing an erosion and sediment control plan helps minimize the negative impacts that <i>construction</i> stormwater runoff can have on coastal Georgia's valuable aquatic and terrestrial resources.
SP&D Criteria #8: Landscaping Plan	Developing a landscaping plan helps ensure that non-invasive, native species are used to landscape low impact development and stormwater management practices, as well as other landscaping features and areas on a development site.
P&D Criteria #9: Stormwater Pollution Prevention Plan	Developing a stormwater pollution prevention plan helps minimize the negative impacts that stormwater hotspots can have on the aquatic and terrestrial resources of coastal Georgia.
Post-Construction Stormwater Management Criteria	
SWM Criteria #1: Stormwater Runoff Reduction	Reducing stormwater runoff volumes helps maintain pre-development site hydrology and helps protect coastal Georgia's aquatic resources from several indirect impacts of the land development process (i.e., decreased groundwater recharge, decreased baseflow, degraded water quality).
SWM Criteria #2: Stormwater Quality Protection	Adequately treating stormwater runoff before it is discharged from a development site helps protect coastal Georgia's aquatic resources from water quality degradation.
SWM Criteria #3: Aquatic Resource Protection	Protecting them from the direct impacts of the land development process and establishing aquatic buffers around them, along with providing extended detention for the stormwater runoff volume generated by the 1-year, 24-hour storm event and providing velocity control and energy dissipation measures at all stormwater outfalls, helps protect coastal Georgia's aquatic resources from several other negative impacts of the land development process (i.e., complete loss or destruction, stream channel enlargement, increased salinity fluctuations).
SWM Criteria #4: Overbank Flood Protection	Controlling (attenuating) the peak discharge generated by the 25-year, 24-hour storm event helps prevent an increase in the duration, frequency and magnitude of damaging overbank flooding.
SWM Criteria #5: Extreme Flood Protection	Controlling (attenuating) the peak discharge generated by the 100-year, 24-hour storm event helps prevent an increase in the duration, frequency and magnitude of dangerous extreme flooding.
Special Stormwater Management and Site Planning and Design Criteria	
Special Criteria #1: Increased Stormwater Runoff Reduction	Providing increased stormwater runoff reduction on development sites located within 1/2-mile of shellfish harvesting areas helps better protect these sensitive natural resources from contamination and closure.
Special Criteria #2: Enhanced Aquatic Resource Protection	Providing wider aquatic buffers around all aquatic resources located within 1/2-mile of shellfish harvesting areas helps better protect these sensitive natural resources from contamination and closure.

References

- Atlanta Regional Commission (ARC). 2001. *Georgia Stormwater Management Manual*. Volume 2. Technical Handbook. Atlanta Regional Commission. Atlanta, GA. Available Online: <http://www.georgiastormwater.com/>.
- Benedict, M.A. and E.T. McMahon. 2006. *Green Infrastructure: Linking Landscapes and Communities*. Island Press. Washington, DC.
- California Stormwater Quality Association (CASQA). 2003. *Municipal Stormwater Best Management Practice Handbook*. California Stormwater Quality Association. Menlo Park, CA. Available Online: <http://www.cabmphandbooks.com/Municipal.asp>.
- Center for Watershed Protection (CWP). 1998. *Better Site Design: A Handbook for Changing Development Rules in Your Community*. Center for Watershed Protection. Ellicott City, MD. Available Online: http://www.cwp.org/Resource_Library/Controlling_Runoff_and_Discharges/sm.htm.
- DeBusk, K. 2008. *Low Impact Development Using a Hydrologic Approach: An Analysis of Pre-Development Hydrology in North Carolina*. Unpublished Manuscript. North Carolina State University. Raleigh, NC.
- Faber-Taylor, A. and F.E. Kuo. 2006. "Is Contact With Nature Important for Healthy Child Development? State of the Evidence." *Children and Their Environments: Learning, Using and Designing Spaces*. C. Spencer and M. Blades (Eds.). Cambridge University Press. Cambridge, UK. Available Online: <http://www.lhhl.uiuc.edu/all.scientific.articles.htm>.
- Franzen, E., S. Wenger, L. Fowler, T. Myers and S. Glaze. 2006. *Protecting Riparian Buffers in Coastal Georgia: Management Options*. University of Georgia. River Basin Center. Athens, GA. Available Online: <http://www.rivercenter.uga.edu/research/coastal.htm>.
- Georgia Department of Natural Resources Wildlife Resources Division (WRD). 2005. *A Comprehensive Wildlife Conservation Strategy for Georgia*. Georgia Department of Natural Resources. Wildlife Resources Division. Social Circle, GA. Available Online: <http://www1.gadnr.org/cwcs/Documents/strategy.html>.
- Georgia Soil and Water Conservation Commission (GSWCC). 2000. *Manual for Erosion and Sediment Control in Georgia*. Georgia Soil and Water Conservation Commission. Athens, GA. Available Online: http://www.georgiaepd.org/Documents/esc_manual.html.
- Holland, F. and D. Sanger. 2008. *Tidal Creek Habitats: Sentinels of Coastal Health*. Hollings Marine Laboratory. Charleston, SC.
- Kuo, F.E. 2003. "The Role of Arboriculture in a Healthy Social Ecology: Invited Review Article for a Special Section." *Journal of Arboriculture*. 29(3): 148-155. Available Online: <http://www.lhhl.uiuc.edu/all.scientific.articles.htm>.
- Kuo, F.E. and W.C. Sullivan. 2001. "Environment and Crime in the Inner City: Does Vegetation Reduce Crime?" *Environment and Behavior*. 33(3): 343-367. Available Online: <http://www.lhhl.uiuc.edu/all.scientific.articles.htm>.

- MacMullan, E. and S. Reich. 2007. *The Economics of Low Impact Development: A Literature Review*. ECONorthwest. Eugene, OR. Available Online: http://www.econw.com/reports/ECONorthwest_Low-Impact-Development-Economics-Literature-Review.pdf.
- National Oceanic and Atmospheric Administration (NOAA). 2008. *Comparative Climatic Data for the United States Through 2007*. National Oceanic and Atmospheric Administration. National Climatic Data Center. Asheville, NC. Available Online: <http://www1.ncdc.noaa.gov/pub/data/ccd-data/CCD-2007.pdf>.
- Novotney, M. 2007. *Development of the Coastal Stormwater Supplement (CSS): Phase I*. Technical Memorandum. Center for Watershed Protection. Ellicott City, MD.
- Rowe, K., J. Spangler and E. Franzen. 2007. *Model Coastal Riparian Buffer Ordinance for Georgia's Local Governments*. University of Georgia. River Basin Center. Athens, GA. Available Online: <http://www.rivercenter.uga.edu/research/coastal.htm>.
- Schueler, T., C. Swann, T. Wright and S. Sprinkle. 2005. *Pollution Source Control Practices*. Urban Subwatershed Restoration Manual Series. Manual 8. Center for Watershed Protection. Ellicott City, MD. Available Online: <http://www.cwp.org/Store/usrm.htm>.
- Schueler, T. 1987. *Controlling Urban Runoff: A Practical Manual for Planning and Designing Urban BMPs*. Metropolitan Washington Council of Governments. Department of Environmental Programs. Washington, DC.
- Sullivan, W.C., F.E. Kuo and S.F. DePooter. 2003. "The Fruit of Urban Nature: Vital Neighborhood Spaces." *Environment and Behavior*. 36(5): 678-700. Available Online: <http://www.lhhl.uiuc.edu/all.scientific.articles.htm>.
- Taylor, A.F., A. Wiley, F.E. Kuo and W.C. Sullivan. 1998. "Growing Up in the Inner City: Green Spaces as Places to Grow." *Environment and Behavior*. 30(1): 3-27. Available Online: <http://www.lhhl.uiuc.edu/all.scientific.articles.htm>.
- U.S. Environmental Protection Agency (US EPA). 2008. "Environmental Benefits of Green Infrastructure." *Managing Wet Weather with Green Infrastructure*. <http://cfpub.epa.gov/npdes/greeninfrastructure/information.cfm#enviroben>. Accessed: June 27, 2008.
- U.S. Environmental Protection Agency (US EPA). 2007. *Developing Your Stormwater Pollution Prevention Plan: A Guide for Construction Sites*. EPA 833-R-06-004. U.S. Environmental Protection Agency. Washington, DC. Available Online: http://www.epa.gov/npdes/pubs/sw_swppp_guide.pdf.
- U.S. Environmental Protection Agency (US EPA). 1993. *Guidance Specifying Management Measures for Sources of Nonpoint Pollution in Coastal Waters*. EPA 840-B-92-002. U.S. Environmental Protection Agency. Office of Wetlands, Oceans and Watersheds. Washington, DC. Available Online: <http://www.epa.gov/nps/MMGI/>.
- Winer-Skonovd, R., D. Hirschman, H.Y. Kwon and C. Swann. 2006. *Synthesis of Existing Cost Information for LID vs. Conventional Practices*. Center for Watershed Protection. Ellicott City, MD.

THIS PAGE INTENTIONALLY LEFT BLANK

5.0 Calculating the Stormwater Runoff Volumes Associated with the Stormwater Management Criteria

5.1 Overview

Section 4.0 presented a set of post-construction stormwater management criteria (SWM Criteria) that can be applied to new development and redevelopment activities occurring within the Coastal Nonpoint Source Management Area and Area of Special Interest. These SWM Criteria help translate the integrated, green infrastructure-based approach to natural resource protection, stormwater management and site design detailed in this Coastal Stormwater Supplement (CSS) into a set of quantitative criteria that can be used to design a post-construction stormwater management system on a development site.

While Section 4.0 provided general information about each of these SWM Criteria, it did not provide guidance on calculating the stormwater runoff volumes associated with them. Therefore, this Section provides information about using accepted hydrologic methods to calculate the stormwater runoff volumes associated with the SWM Criteria that apply to a development site. These calculations can be used to plan and design a post-construction stormwater management system that will satisfy the stormwater management and site planning and design criteria presented in this CSS.

Although there are a number of hydrologic methods that can be used to evaluate site hydrology, the hydrologic methods presented in this Section were selected because of their accuracy in predicting stormwater runoff rates and volumes and because there are a variety of guidance materials and computer programs that support their use.

5.2 Calculating the Stormwater Runoff Volume Associated with the Stormwater Runoff Reduction Criteria (SWM Criteria #1)

The amount of stormwater runoff reduction needed to satisfy the stormwater runoff reduction criteria (SWM Criteria #1), known as the runoff reduction volume (RR_v), can be calculated by multiplying the depth of rainfall generated by the target runoff reduction rainfall event (e.g., 85th percentile storm event, 90th percentile storm event) by the site area and a volumetric runoff coefficient (R_v):

$$RR_v = (P)(R_v)(A) \div (12)$$

Where:

- RR_v = runoff reduction volume (acre-feet)
- P = target runoff reduction rainfall (inches)
- R_v = volumetric runoff coefficient
- A = site area (acres)
- 12 = unit conversion factor (in./ft.)

Schueler (1987) demonstrated that a site's volumetric runoff coefficient, R_v , is directly related to the amount of impervious cover found on the site:

$$R_v = 0.05 + 0.009(I)$$

Where:

- I = site imperviousness (%)

Except on development sites located within 1/2-mile of a shellfish harvesting area, the amount of rainfall generated by the target runoff reduction rainfall event (i.e., 85th percentile storm event) is 1.2 inches. Therefore, on most development sites located within coastal Georgia, RR_v can be calculated using the following equation:

$$RR_v = (1.2 \text{ in.})(R_v)(A) \div (12)$$

Where:

- RR_v = runoff reduction volume (acre-feet)
- R_v = volumetric runoff coefficient
- A = site area (acres)
- 12 = unit conversion factor (in./ft.)

On development sites located within 1/2-mile of a shellfish harvesting area (Section 4.5.1), the amount of rainfall generated by the target runoff reduction rainfall event (i.e., 90th percentile storm event) is 1.5 inches. On these development sites, RR_v can be calculated using the following equation:

$$RR_v = (1.5 \text{ in.})(R_v)(A) \div (12)$$

Where:

- RR_v = runoff reduction volume (acre-feet)
- R_v = volumetric runoff coefficient
- A = site area (acres)
- 12 = unit conversion factor (in./ft.)

Additional Information

Additional information about calculating the stormwater runoff volume associated with the stormwater runoff reduction criteria (SWM Criteria #1) is provided below:

- Measuring Impervious Area: The amount of impervious cover found on a development site can be read directly from a set of development plans or calculated using aerial photography and appropriate computer software.
- Multiple Drainage Areas: When a development site contains or is divided into multiple drainage areas, it is *recommended* that RR_v be calculated and addressed separately within each drainage area.
- Off-Site Drainage Areas: Stormwater runoff from off-site drainage areas may be diverted and conveyed around a development site and excluded from the RR_v calculations.

Example

Box 5.1 demonstrates how to calculate the stormwater runoff volume associated with the stormwater runoff reduction criteria (SWM Criteria #1) on a development site.

Box 5.1: Calculating the Runoff Reduction Volume

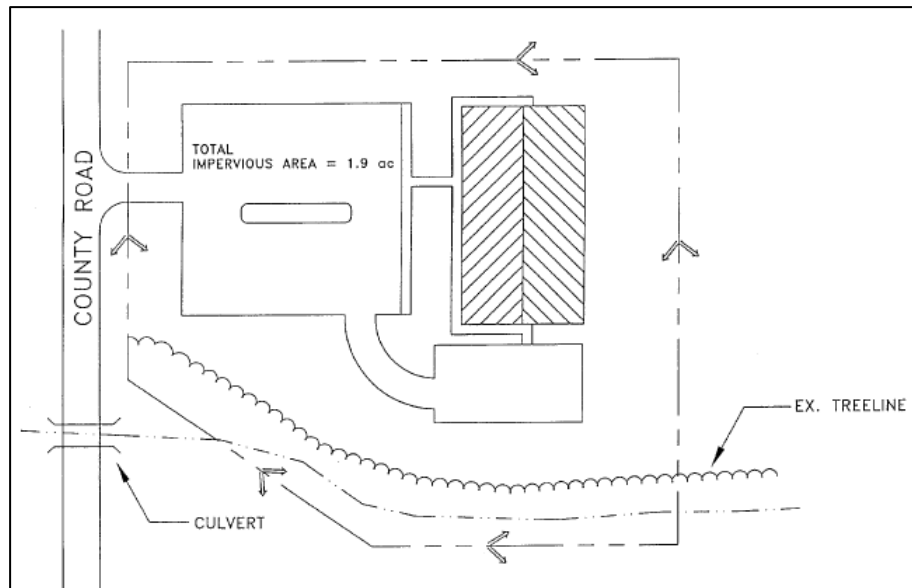

Figure 5.1: Bay Street Community Center, Savannah, GA
(Source: Atlanta Regional Commission, 2001)

Site Data

Site Area, A = 3.0 acres
 Pre-Development Impervious Area = 0.0 acres
 Post-Development Impervious Area = 1.9 acres
 Soils = Hydrologic Soil Group "B" Soils

Hydrologic Data

Target Runoff Reduction Rainfall Event = 1.2 inches
 Pre-Development Site Imperviousness, $I_{pre} = 0.0 \div 3.0 = 0.0\%$
 Post-Development Site Imperviousness, $I_{post} = 1.9 \div 3.0 = 63.3\%$

(1) Compute Volumetric Runoff Coefficient, Rv

$$Rv = 0.05 + 0.009(I)$$

$$Rv = 0.05 + 0.009(63.3) = 0.62$$

(2) Compute Runoff Reduction Volume, RRV

$$RRv = (1.2 \text{ in.})(Rv)(A) \div (12 \text{ in./ft.})$$

$$RRv = (1.2 \text{ in.})(0.62)(3.0 \text{ ac.}) \div (12 \text{ in./ft.})$$

$$RRv = 0.186 \text{ ac-ft}$$

5.3 Calculating the Stormwater Runoff Volume Associated with the Water Quality Protection Criteria (SWM Criteria #2)

The water quality protection criteria (SWM Criteria #2) states that if any of the stormwater runoff volume generated by the target runoff reduction rainfall event (e.g., 85th percentile storm event, 90th percentile storm event) cannot be *reduced* on a development site, due to site characteristics or constraints, it should be *intercepted and treated* in one or more stormwater

management practices that: (1) provide for at least an 80 percent reduction in TSS loads; and (2) reduce nitrogen and bacteria loads to the *maximum extent practical*. Consequently, the hydrologic methods used to calculate the stormwater runoff volume associated with this SWM Criteria are the same as those described in Section 5.2.

5.4 Calculating the Stormwater Runoff Volume Associated with the Aquatic Resource Protection Criteria (SWM Criteria #3)

An estimate of the amount of storage needed to provide 24 hours of extended detention for the stormwater runoff volume generated by the 1-year, 24-hour storm event, which is known as the aquatic resource protection volume (ARP_v), can be obtained using the nine-step procedure outlined below. This procedure, which was originally developed by Harrington (1987), is a modified version of the Graphical Peak Discharge and Storage Volume Estimation Methods presented in *Technical Release 55 (TR-55)* (NRCS, 1986). Although the procedure outlined below can be used to estimate the aquatic resource protection volume (ARP_v), standard storage routing procedures should be used to conduct the final design of any post-construction stormwater management system used on a development site.

5.4.1 Step 1: Determine the Amount of Rainfall Generated by the 1-Year, 24-Hour Storm Event

The amount of rainfall generated by the 1-year, 24-hour storm event varies depending on the location of the development site within the 24-county coastal region. It can be determined using the rainfall tables for Brunswick and Savannah provided in Appendix A of Volume 2 of the *Georgia Stormwater Management Manual* (ARC, 2001).

5.4.2 Step 2: Determine the Runoff Curve Number for the Development Site Under Post-Development Conditions

According to the Natural Resources Conservation Service (NRCS, 1986), the principal factors affecting the relationship between rainfall and runoff are soil type, land cover, land cover treatment, land cover hydrologic condition and antecedent moisture condition. The SCS Runoff Curve Number Method (NRCS, 1986) uses a combination of these factors to assign a runoff coefficient to an area, such as a development site. These runoff coefficients, known as runoff curve numbers (CNs), summarize the runoff potential of a particular area; the higher an area's CN, the higher its runoff potential. Each of the factors that influence an area's CN are discussed briefly below.

Soil Type

Since different soil types have different infiltration rates, soils have a significant influence on the relationship between rainfall and runoff on a development site. Based on their observed minimum infiltration rates, the SCS Runoff Curve Number Method (NRCS, 1986) places different soil types into one of four hydrologic soil groups (HSGs):

- **Group A:** Group A soils have low runoff potential and high infiltration rates even when thoroughly wetted. They consist chiefly of deep, well to excessively drained sand or gravel.
- **Group B:** Group B soils have moderate infiltration rates when thoroughly wetted and consist chiefly of moderately deep to deep, moderately well to well drained soils with moderately fine to moderately coarse textures.

- **Group C:** Group C soils have low infiltration rates when thoroughly wetted and consist chiefly of soils with a layer that impedes downward movement of water and soils with moderately fine to fine texture.
- **Group D:** Group D soils have high runoff potential. They have very low infiltration rates when thoroughly wetted and consist chiefly of clay soils with a high swelling potential, soils with a permanent high water table, soils with a claypan or clay layer at or near the surface and shallow soils over nearly impervious material.

Information about the different soil types that can be found in coastal Georgia, including information about their assigned HSGs, can be found in Appendix A of TR-55 (NRCS, 1986) and in Appendix B of Volume 2 of the *Georgia Stormwater Management Manual* (ARC, 2001). Natural Resources Conservation Service soil surveys also provide information about the different soil types that can be found throughout the 24-county coastal region.

It is important to note that the land development process may significantly alter the soils found on a development site. Native soils may be removed, fill materials from other development sites may be introduced and clearing, grading and other land disturbing activities (e.g., compaction) may reduce soil infiltration rates. Consequently, the HSGs originally assigned to the soil types found on a development site may no longer apply to those soils after the land development process has been completed. In these situations, it is recommended that new HSGs be assigned to the soils according to their texture (Table 5.1), provided that significant compaction of the soils has not occurred (Brakensiek and Rawls, 1983).

Table 5.1: Classifying Hydrologic Soil Groups According to Soil Texture
(Source: NRCS, 1986)

Hydrologic Soil Group	Soil Texture
A	Sand, loamy sand or sandy loam
B	Silt loam or loam
C	Sandy clay loam
D	Clay loam, silty clay loam, sandy clay, silty clay, or clay

The Ocean County, NJ Soil Conservation District (OCSCD, 2001), investigated the effects of soil compaction on soil infiltration rates and hydrologic soil group classifications. The study found that soil compaction leads to a significant reduction in soil infiltration rates and a significant increase in stormwater runoff volumes on development sites. The study found that, although the soils found on a particular development site could be classified as HSG A or B soils, based on soil survey data and soil texture information (Table 5.1), observations showed that the actual infiltration rates of the soils were less 0.15 in./hr, which is more characteristic of HSG Group C or D soils (OCSCD, 2001). Therefore, it is *recommended* that some effort be made to account for the effects of soil compaction when assigning new HSGs to the soil types found on a development site. Until more extensive guidance on this topic is available, it may be advisable to adjust a particular soil's HSG down by a group or two, depending on the extent of compaction that has occurred or will occur on the development site.

Land Cover

In the SCS Runoff Curve Number Method (NRCS, 1986), this parameter is used to represent the type of land cover found on a development site. Land cover types included in the SCS Runoff Curve Number Method (NRCS, 1986) include vegetation, litter, mulch, bare soil and impervious surfaces. There are a number of methods that can be used to determine the land cover found

on a development site, including field reconnaissance and interpretation from aerial photography and land use maps.

Land Cover Treatment

In the SCS Runoff Curve Number Method (NRCS, 1986), this parameter is used to further describe the land cover found on a development site. It applies mainly to cultivated agricultural lands and addresses land management practices, such as contouring, terracing, crop rotation, grazing control and reduced tillage.

Land Cover Hydrologic Condition

The land cover hydrologic condition factor is used to describe the effects of land cover type and land cover treatment on soil infiltration rates. The SCS Runoff Curve Number Method (NRCS, 1986) defines three possible hydrologic conditions for land covers:

- **Good**: Land covers in good hydrologic condition usually have the lowest runoff potential for a given hydrologic soil group, land cover and land cover treatment.
- **Fair**: Land covers in fair hydrologic condition usually have a moderate runoff potential for a given hydrologic soil group, land cover and land cover treatment.
- **Poor**: Land covers in poor hydrologic condition usually have the highest runoff potential for a given hydrologic soil group, land cover and land cover treatment.

Some of the factors that play a role in defining the hydrologic condition of a given land cover include: (1) density of canopy or vegetation on lawns, croplands and other vegetated areas; (2) amount of year-round vegetative cover; (3) amount of grass or close-seeded legumes in crop rotations; (4) percent of residue cover; and (5) degree of surface roughness.

Antecedent Moisture Condition

The antecedent moisture condition (AMC) (also known as the *antecedent runoff condition*), is used to describe the runoff potential of a particular area prior to a storm event. The AMC is an attempt to account for the variation in observed CNs that occurs at a site from one storm event to the next. This variation in CNs is a result of the change in soil infiltration rates and soil water storage capacities that occur within the soil profile in between storm events, due to evapotranspiration, infiltration and drainage (NRCS, 1985).

In the SCS Runoff Curve Number Method (NRCS, 1986), three different AMCs can be used to describe the runoff potential of a particular hydrologic soil group, land cover, land cover treatment and land cover hydrologic condition prior to a storm event:

- **AMC-I**: AMC-I represents relatively dry antecedent moisture conditions. It represents the upper limit of the soil infiltration rates and soil water storage capacities that can be measured on a development site.
- **AMC-II**: AMC-II represents average antecedent moisture conditions and is the AMC most commonly used in stormwater design. It represents the average value of the soil infiltration rates and soil water storage capacities that can be measured on a development site.

- **AMC-III:** AMC-III represents relatively wet antecedent moisture conditions. It represents the lower limit of the soil infiltration rates and soil water storage capacities that can be measured on a development site.

Although correctly describing the runoff potential of a particular area prior to a storm event is essential to the application of the SCS Runoff Curve Number Method (NRCS, 1986), there is limited guidance on how to accomplish this task. Previous versions of Section 4 of the National Engineering Handbook (NEH-4) (NRCS, 1964), stated that the AMC of a particular hydrologic soil group, land cover, land cover treatment and land cover hydrologic condition can be determined by evaluating the total amount of rainfall that has fallen on a site in a five-day period leading up to the design storm event (i.e., total 5-day antecedent rainfall) and comparing them to the seasonal rainfall limits listed in Table 5.2.

Table 5.2: Antecedent Moisture Conditions and Seasonal Rainfall Limits
(Source: NRCS, 1964)

Antecedent Moisture Condition	Total 5-Day Antecedent Rainfall (in.)	
	Dormant Season	Growing Season
AMC-I	Less than 0.5	Less than 1.4
AMC-II	0.5 to 1.1	1.4 to 2.1
AMC-III	More than 1.1	More than 2.1

5.4.2.1 Runoff Curve Numbers

Tables 5.3-5.5 list the runoff curve numbers associated with the average antecedent moisture conditions (i.e., AMC-II) for urban, cultivated agricultural and other agricultural lands.

Table 5.3: Runoff Curve Numbers for Urban Lands¹
(Source: NRCS, 1986)

Land Cover and Hydrologic Condition	Average Percent Impervious Area ²	Curve Numbers for Hydrologic Soil Group			
		A	B	C	D
Open space (lawns, parks, golf courses, cemeteries, etc.) ³ :					
Poor condition (grass cover < 50%)		68	79	86	89
Fair condition (grass cover 50% to 75%)		49	59	79	84
Good condition (grass cover > 75%)		39	61	74	80
Impervious areas:					
Paved parking lots, roofs, driveways, etc. (excluding right-of-way)		98	98	98	98
Streets and roads:					
Paved; curbs and storm sewers (excluding right-of-way)		98	98	98	98
Paved; open ditches (including right-of-way)		83	89	92	93
Gravel (including right-of-way)		76	85	89	91
Dirt (including right-of-way)		72	82	87	89
Western desert urban areas:					
Natural desert landscaping (pervious areas only) ⁴		63	77	85	88
Artificial desert landscaping (impervious weed barrier, desert shrub with 1- to 2-inch sand or gravel mulch, and basin borders)		96	96	96	96
Urban districts:					
Commercial and business	85	89	92	94	95
Industrial	72	81	88	91	93
Residential districts by average lot size:					
1/8 acre or less (town houses)	65	77	85	90	92
1/4 acre	38	61	75	83	87
1/3 acre	30	57	72	81	86
1/2 acre	25	54	70	80	85
1 acre	20	51	68	79	84
2 acres	12	46	65	77	82
Developing urban areas					
Newly graded areas (pervious areas only, no vegetation) ⁵		77	86	91	94
Idle lands (CNs are determined using cover types similar to those in Table 5.5)					
Notes:					
1 Average moisture condition and $I_a = 0.2S$					
2 The average percent impervious area shown was used to develop the composite CNs. Other assumptions are as follows: impervious areas are directly connected to the drainage system, impervious areas have a CN of 98, and pervious areas are considered equivalent to open space in good hydrologic condition. CNs for other combinations of conditions may be computed using Figure 2-3 or 2-4 in TR-55 (NRCS, 1986).					
3 CNs shown are equivalent to those of pasture. Composite CNs may be computed for other combinations of open space cover type.					
4 Composite CNs for natural desert landscaping should be computed using Figures 2-3 or 2-4 in TR-55 (NRCS, 1986) based on the impervious area percentage (CN = 98) and the pervious area CN. The pervious area CNs are assumed equivalent to desert shrub in poor hydrologic condition.					
5 Composite CNs to use for the design of temporary measures during grading and construction should be computed using Figures 2-3 or 2-4 in TR-55 (NRCS, 1986) based on the degree of development (impervious area percentage) and the CNs for the newly graded pervious areas.					

Table 5.4: Runoff Curve Numbers for Cultivated Agricultural Lands¹
(Source: NRCS, 1986)

Land Cover Description			Curve Numbers for Hydrologic Soil Group			
Cover Type	Treatment ²	Hydrologic Condition ³	A	B	C	D
Fallow	Bare soil		77	86	91	94
	Crop residue cover (CR)	Poor	76	85	90	93
		Good	74	83	88	90
Row crops	Straight row (SR)	Poor	72	81	88	91
		Good	67	78	85	89
	SR + CR	Poor	71	80	87	90
		Good	64	75	82	85
	Contoured (C)	Poor	70	79	84	88
		Good	65	75	82	86
	C + CR	Poor	69	78	83	87
		Good	64	74	81	85
	Contoured & terraced (C&T)	Poor	66	74	80	82
		Good	62	71	78	81
	C&T + CR	Poor	65	73	79	81
		Good	61	70	77	80
Small grain	SR	Poor	65	76	84	88
		Good	63	75	83	87
	SR + CR	Poor	64	75	83	86
		Good	60	72	80	84
	C	Poor	63	74	82	85
		Good	61	73	81	84
	C + CR	Poor	62	73	81	84
		Good	60	72	80	83
	C&T	Poor	61	72	79	82
		Good	59	70	78	81
	C&T + CR	Poor	60	71	78	81
		Good	58	69	77	80
Close-seeded or broadcast legumes or rotation meadow	SR	Poor	66	77	85	89
		Good	58	72	81	85
	C	Poor	64	75	83	85
		Good	55	69	78	83
	C&T	Poor	63	73	80	83
		Good	51	67	76	80

Notes:

1 Average moisture condition and $I_a = 0.2S$

2 Crop residue cover applies only if residue is on at least 5% of the surface throughout the year.

3 Hydrologic condition is based on combination of factors that affect infiltration and runoff, including (a) density and canopy of vegetative areas, (b) amount of year-round cover, (c) amount of grass or close-seeded legumes, (d) percent of residue cover on the land surface (good $\geq 20\%$), and (e) degree of surface roughness.

Poor: Factors impair infiltration and tend to increase runoff.

Good: Factors encourage average and better than average infiltration and tend to decrease runoff.

Table 5.5: Runoff Curve Numbers for Other Agricultural Lands¹
(Source: NRCS, 1986)

Land Cover Description		Curve Numbers for Hydrologic Soil Group			
Cover Type	Hydrologic Condition	A	B	C	D
Pasture, grassland, or range—continuous forage for grazing ²	Poor	68	79	86	89
	Fair	49	69	79	84
	Good	39	61	74	80
Meadow—continuous grass, protected from grazing and generally mowed for hay		30	58	71	78
Brush—brush-weed-grass mixture with brush the major element ³	Poor	48	67	77	83
	Fair	35	56	70	77
	Good	30 ⁴	48	65	73
Woods—grass combination (orchard or tree farm) ⁵	Poor	57	73	82	86
	Fair	43	65	76	82
	Good	32	58	72	79
Woods ⁶	Poor	45	66	77	83
	Fair	36	60	73	79
	Good	30 ⁴	55	70	77
Farmsteads—buildings, lanes, driveways, and surrounding lots		59	74	82	86
<p>Notes:</p> <p>1 Average moisture condition and $I_a = 0.2S$</p> <p>2 Poor: < 50% ground cover or heavily grazed with no mulch. Fair: 50% to 75% ground cover and not heavily grazed. Good: > 75% ground cover and lightly or only occasionally grazed.</p> <p>3 Poor: < 50% ground cover. Fair: 50% to 75% ground cover. Good: > 75% ground cover.</p> <p>4 Actual curve number is less than 30; use CN = 30 for runoff computations.</p> <p>5 CNs shown were computed for areas with 50% woods and 50% grass (pasture) cover. Other combinations of conditions may be computed from the CNs for woods and pasture.</p> <p>6 Poor: Forest litter, small trees, and brush are destroyed by heavy grazing or regular burning. Fair: Woods are grazed but not burned, and some forest litter covers the soil. Good: Woods are protected from grazing, and litter and brush adequately cover the soil.</p>					

5.4.3 Step 3: Compute the Stormwater Runoff Volume Generated by the 1-Year, 24-Hour Storm Event Under Post-Development Conditions

The stormwater runoff volume generated by the 1-year, 24-hour storm event can be calculated using the SCS Runoff Equation (NRCS, 1986):

$$Q = \frac{P - (0.2)\left(\frac{1000}{CN} - 10\right)}{P + (0.8)\left(\frac{1000}{CN} - 10\right)} \times A \div 12$$

Where:

- Q = stormwater runoff volume (acre-feet)
- P = rainfall (inches)
- CN = runoff curve number
- A = site area (acres)
- 12 = unit conversion factor (in./ft.)

5.4.4 Step 4: Determine the Initial Abstraction and Initial Abstraction Ratio Under Post-Development Conditions

Through the study of many small agricultural watersheds, the Natural Resource Conservation Service (NRCS, 1986) found that the following equation can be used to relate the initial abstraction (I_a) to a site's CN:

$$I_a = (0.2)\left(\frac{1000}{CN} - 10\right)$$

Where:

- I_a = initial abstraction (inches)
- CN = runoff curve number

The initial abstraction (I_a) represents the fraction of the rainfall that is retained in surface depressions, intercepted by vegetation or lost to evaporation and infiltration before runoff begins. Table 5.6 summarizes the values of I_a for a range of CNs.

CN	I_a	CN	I_a	CN	I_a
40	3.000	60	1.333	80	0.500
41	2.878	61	1.279	81	0.469
42	2.762	62	1.226	82	0.439
43	2.651	63	1.175	83	0.410
44	2.545	64	1.125	84	0.381
45	2.444	65	1.077	85	0.353
46	2.348	66	1.030	86	0.326
47	2.255	67	0.985	87	0.299
48	2.167	68	0.941	88	0.273
49	2.082	69	0.899	89	0.247

Table 5.6: Initial Abstraction Values for Runoff Curve Numbers
(Source: NRCS, 1986)

CN	I _a	CN	I _a	CN	I _a
50	2.000	70	0.857	90	0.222
51	1.922	71	0.817	91	0.198
52	1.846	72	0.778	92	0.174
53	1.774	73	0.740	93	0.151
54	1.704	74	0.703	94	0.128
55	1.636	75	0.667	95	0.105
56	1.571	76	0.632	96	0.083
57	1.509	77	0.597	97	0.062
58	1.448	78	0.564	98	0.041
59	1.390	79	0.532		

Once the I_a has been determined, the initial abstraction ratio (I_a/P) can be determined simply by dividing the initial abstraction (I_a) by the amount of rainfall generated by the target (i.e., 1-year, 24-hour) storm event (P).

5.4.5 Step 5: Determine the Time of Concentration for the Development Site Under Post-Development Conditions

Travel time (T_t) is the time that it takes for stormwater runoff to travel from one point to the next on a development site. It can be computed using the following equation:

$$T_t = \frac{L}{(3600)(V)}$$

Where:

- T_t = travel time (hours)
- L = length of flow path (feet)
- V = average flow velocity (feet per second)
- 3600 = unit conversion factor (sec./hr.)

The time of concentration (T_c) is the time that it takes for stormwater runoff to travel from the most hydraulically distant point on a development site to a point of interest, such as stormwater pond or stormwater outfall. It is computed by determining the flow path that stormwater runoff will follow on the development site and summing the T_t values for the various flow segments found on that flow path:

$$T_c = T_{t1} + T_{t2} + \dots + T_{tm}$$

Where:

- T_c = time of concentration (hours)
- m = number of flow segments

Stormwater runoff can move across a development site as sheet flow, shallow concentrated flow, open channel flow or some combination of the three. Each of these flow types is described briefly below.

Sheet Flow

Sheet flow is flow over a planar surface. It usually occurs in the most upstream reaches of a flow path or stream. It is affected by surface roughness and land slope.

The travel time within a sheet flow segment can be computed using Manning's kinematic solution (Overton and Meadows, 1976):

$$T_t = \frac{(0.007)(nL)^{0.8}}{(P_2)^{0.5} (s)^{0.4}}$$

Where:

- T_t = travel time (hours)
- n = Manning's roughness coefficient for sheet flow
- L = length of sheet flow segment (feet)
- P₂ = amount rainfall generated by 2-year, 24-hour rainfall event (inches)
- s = slope of hydraulic grade line or land slope (ft./ft.)

This simplified form of the Manning's kinematic solution is based on the following assumptions: (1) shallow, steady, uniform flow; (2) constant intensity of rainfall excess (the portion of rainfall available for runoff); (3) rainfall duration of 24 hours; and (4) infiltration has minor effects on travel time.

The amount of rainfall generated by the 2-year, 24-hour rainfall event can be determined using the rainfall tables for Brunswick and Savannah provided in Appendix A of Volume 2 of the *Georgia Stormwater Management Manual* (ARC, 2001). Values for Manning's roughness coefficient for sheet flow (n) can be obtained from Table 5.7.

Surface Description	n ¹
Smooth surfaces (concrete, asphalt, gravel, or bare soil)	0.011
Fallow (no residue)	0.05
Cultivated soils:	
Residue cover ≤ 20%	0.06
Residue cover > 20%	0.17
Grass:	
Short grass prairie	0.15
Dense grasses ²	0.24
Bermuda grass	0.41
Range (natural)	0.13
Woods: ³	
Light underbrush	0.40
Dense underbrush	0.80
Notes:	
1 The n values are a composite of information compiled by Engman (1986).	
2 Includes species such as weeping lovegrass, bluegrass, buffalo grass, blue grama grass and native grass mixtures.	
3 When selecting n, consider cover to a height of about 0.1 ft. This is the only part of the plant cover that will obstruct sheet flow.	

Shallow Concentrated Flow

After a maximum of 75 to 150 feet, sheet flow typically becomes shallow concentrated flow. The average velocity for this type of flow can be determined by using Figure 5.2, in which average velocity is provided as a function of watercourse slope and channel type.

The average velocity of shallow concentrated flow can also be computed using the following equations, which can also be used to compute the velocity of shallow concentrated flow on watercourse slopes less than 0.005 ft./ft. (NRCS, 1986):

Unpaved Surface

$$V = 16.1345(s)^{0.5}$$

Where:

V = average velocity (ft./sec.)

S = slope of hydraulic grade line or watercourse slope (ft./ft.)

Paved Surface

$$V = 20.3282(s)^{0.5}$$

Where:

V = average velocity (ft./sec.)

s = slope of hydraulic grade line or watercourse slope (ft./ft.)

After determining the average velocity of shallow concentrated flow, use the following equation to estimate the travel time within the shallow concentrated flow segment:

$$T_t = \frac{L}{(3600)(V)}$$

Where:

T_t = travel time (hours)

L = length of shallow concentrated flow segment (feet)

V = average velocity of shallow concentrated flow (feet per second)

3600 = unit conversion factor (sec./hr.)

Open Channel Flow

Open channel flow is assumed to begin where surveyed cross section information has been obtained, where channels are visible on aerial photographs, where channels have been identified by the local development review authority or where blue lines, which indicate streams, appear on U.S. Geological Survey (USGS) quadrangle maps. Manning's equation or water surface profile information can be used to estimate the average flow velocity within an open channel segment. The average flow velocity within an open channel segment is usually determined at bankfull conditions within the channel of interest.

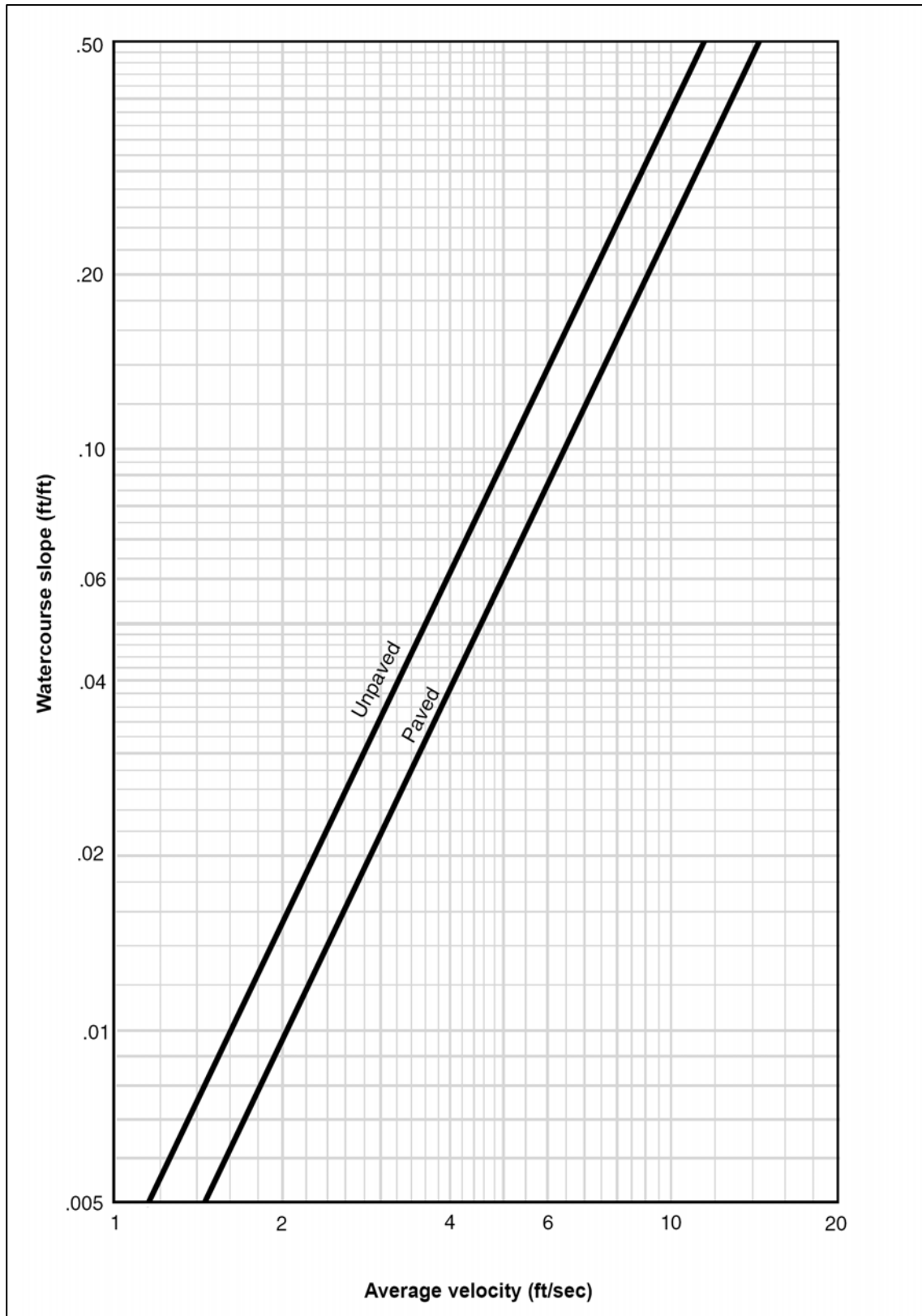

Figure 5.2: Average Velocities for Estimating Travel Time for Shallow Concentrated Flow
 (Source: Natural Resources Conservation Service, 1986)

Manning's equation is:

$$V = \frac{(1.49)(R_h)^{2/3}(s)^{1/2}}{n}$$

Where:

- V = average velocity of open channel flow (feet per second)
- R_h = hydraulic radius (feet)
- s = slope of hydraulic grade line or channel slope (ft./ft.)
- n = Manning's roughness coefficient for open channel flow

Values for Manning's roughness coefficient for open channel flow (n) can be obtained from standard hydrology textbooks. The hydraulic radius (R_h) of an open channel cross section can be computed using the following equation:

$$R_h = \frac{A}{P_w}$$

Where:

- R_h = hydraulic radius (feet)
- A = flow area of open channel cross section (square feet)
- P_w = wetted perimeter of open channel cross section (feet)

After determining the average velocity of open channel flow, use the following equation to estimate the travel time within the open channel flow segment:

$$T_t = \frac{L}{(3600)(V)}$$

Where:

- T_t = travel time (hours)
- L = length of open channel flow segment (feet)
- V = average velocity of open channel flow (feet per second)
- 3600 = unit conversion factor (sec./hr.)

5.4.6 Step 6: Compute the Uncontrolled Peak Discharge Under Post-Development Conditions

The next step in the procedure is to compute the uncontrolled peak discharge generated on the development site by the 1-year, 24-hour storm event under post-development conditions. This requires the unit peak discharge (q_u) to be determined.

The unit peak discharge (q_u) can be determined using the previously obtained values of I_a/P (Section 5.4.4) and T_c (Section 5.4.5), knowledge about the rainfall distribution on the development site (e.g., Type II, Type III) (Figure 5.3) and Figure 5.4 or Figure 5.5, whichever is appropriate. If the initial abstraction ratio (I_a/P) is outside the range of values provided in the figures, then the appropriate boundary value of q_u should be used. Linear interpolation can be used to estimate q_u when the value of I_a/P falls between the values provided in the figures.

The uncontrolled peak discharge (q_i) generated on the development site by the 1-year, 24-hour storm event can be determined using the unit peak discharge (q_u) and the following equation:

$$q_i = (q_u)(A)(Q)(F_p)$$

Where:

- q_i = uncontrolled peak discharge (cubic feet per second)
- q_u = unit peak discharge (cubic feet per second per square mile per inch)
- Q = stormwater runoff volume (inches)
- A = site area (square miles)
- F_p = pond and swamp adjustment factor

The pond and swamp adjustment factor (F_p) is used to account for pond and swamp areas that are spread across a development site and are not accounted for in the time of concentration (T_c) calculations (Section 5.4.5). Values for the pond and swamp adjustment factor (F_p) can be obtained from Table 5.8.

% of Site in Pond and Swamp Areas	F_p	% of Site in Pond and Swamp Areas	F_p
0.0	1.00	3.0	0.75
0.2	0.97	5.0	0.72
1.0	0.87		

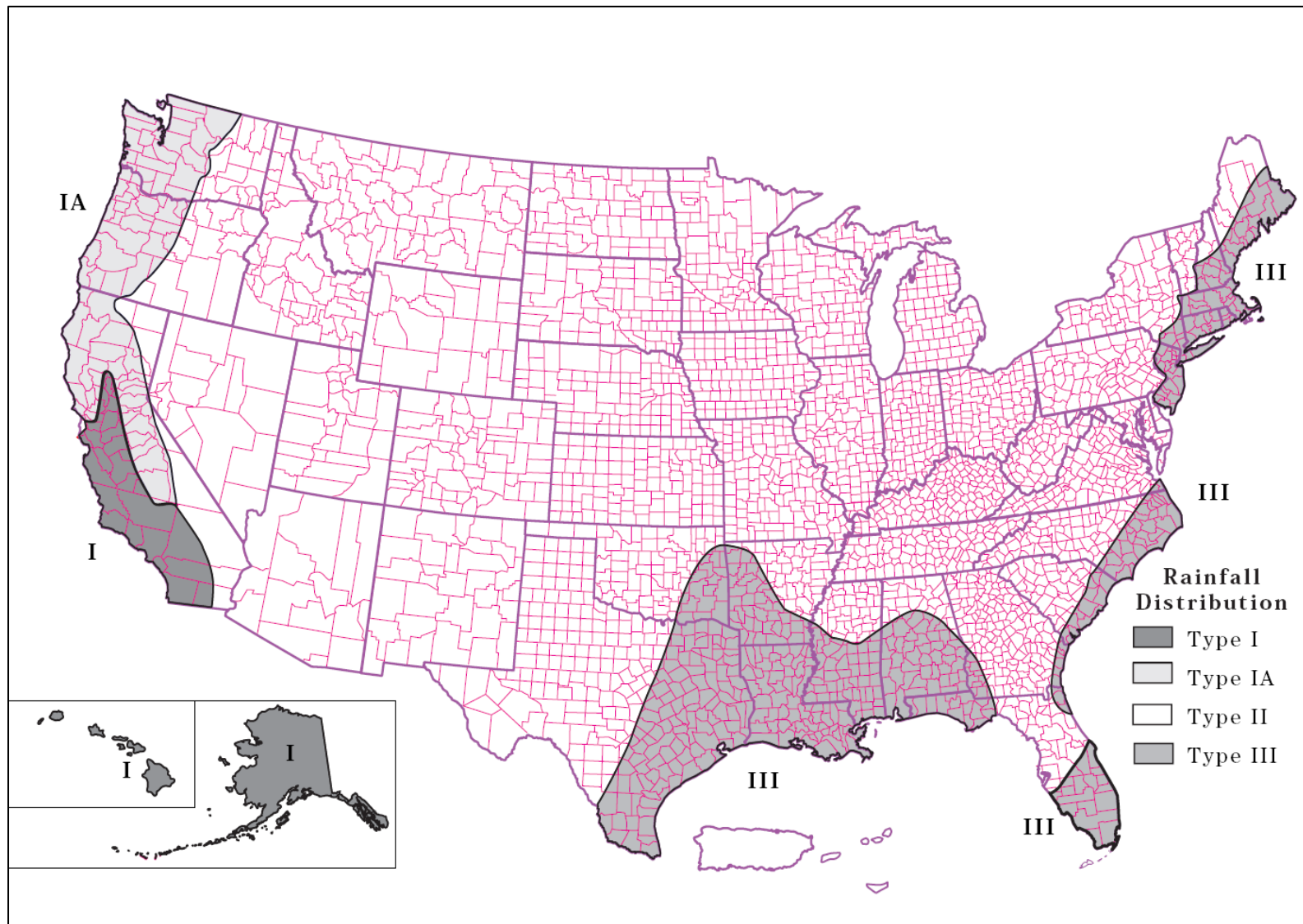

Figure 5.3: Approximate Geographic Boundaries for NRCS (SCS) Rainfall Distributions
(Source: Natural Resources Conservation Service, 1986)

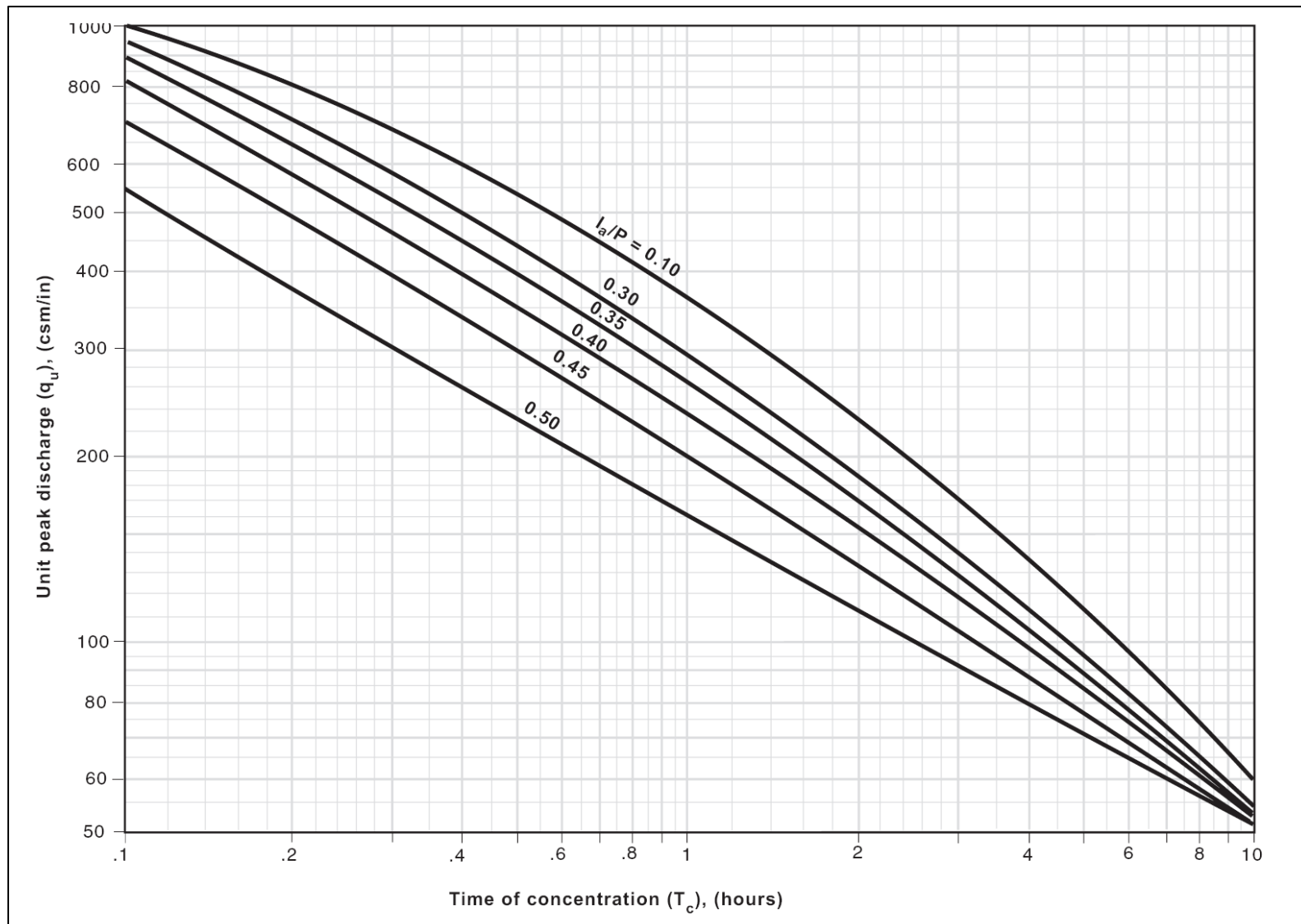

Figure 5.4: Unit Peak Discharge for NRCS (SCS) Type II Rainfall Distribution
 (Source: Natural Resources Conservation Service, 1986)

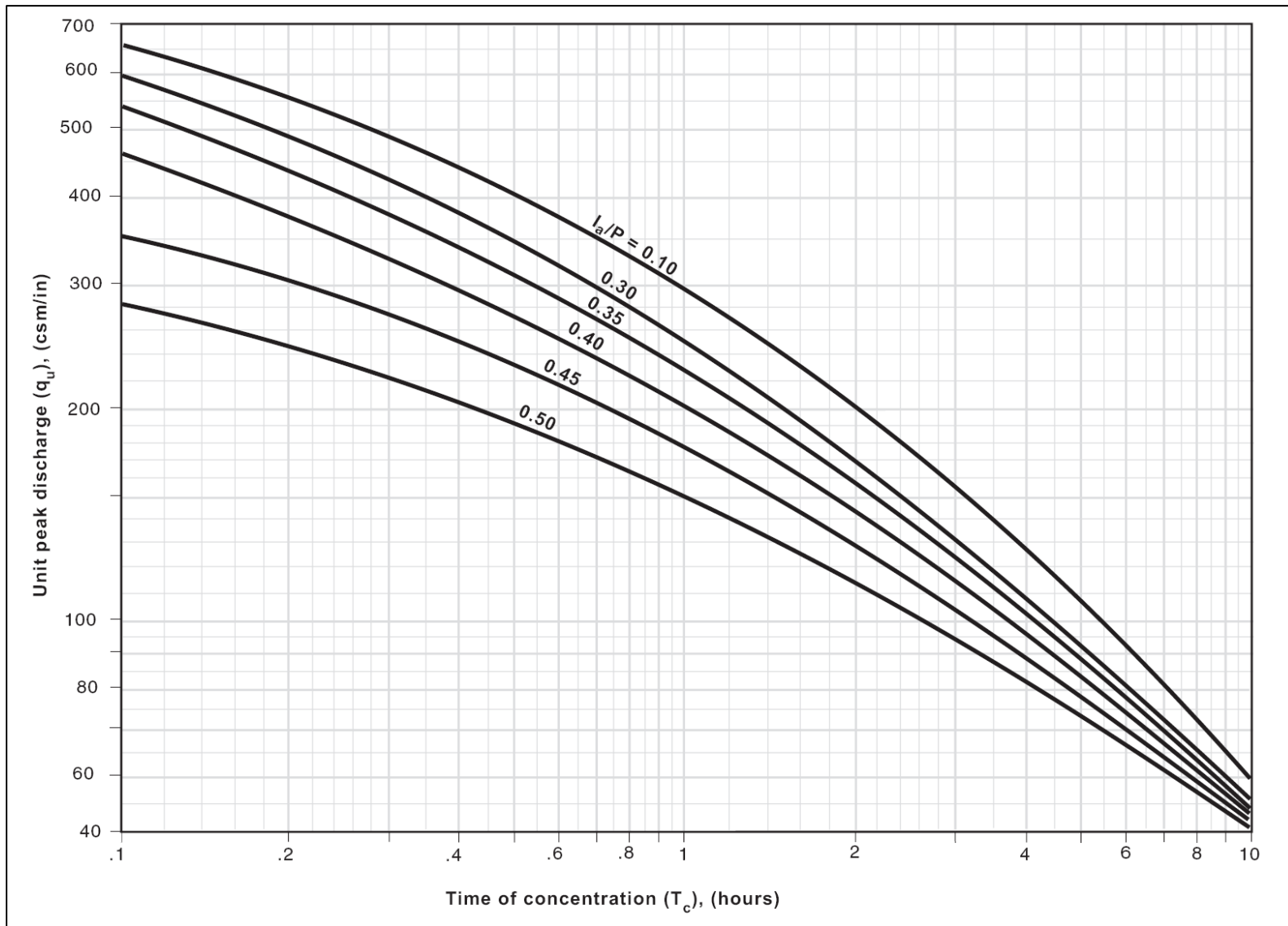

Figure 5.5: Unit Peak Discharge for NRCS (SCS) Type III Rainfall Distribution
 (Source: Natural Resources Conservation Service, 1986)

5.4.7 Step 7: Determine the Ratio of the Controlled Peak Discharge to the Uncontrolled Peak Discharge

The value of the ratio of the controlled peak discharge to the uncontrolled peak discharge (q_o/q_i) can be determined using the previously obtained value of the unit peak discharge (q_u) (Section 5.4.6), the required extended detention time (T) (i.e., 24 hours) and Figure 5.6.

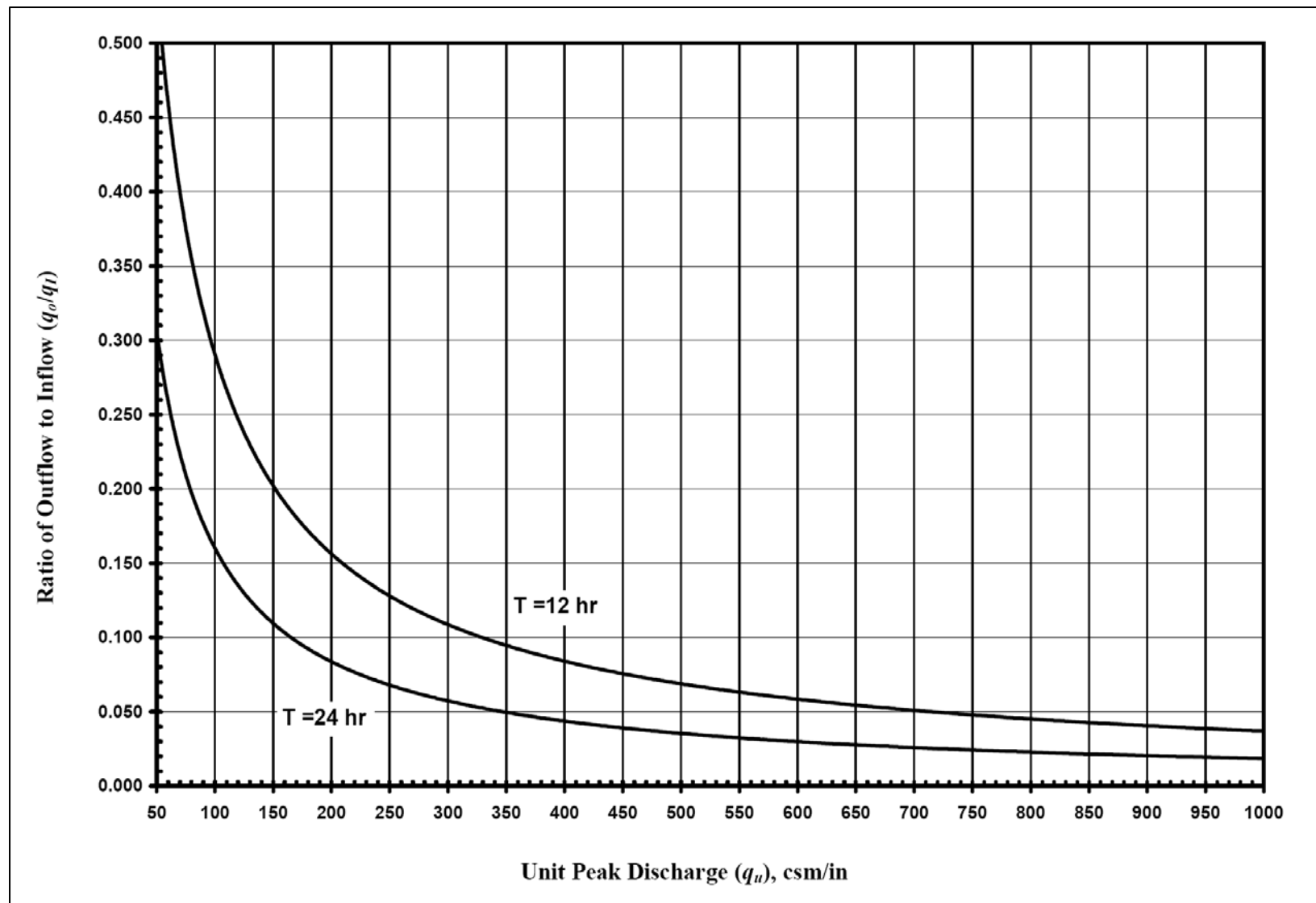

Figure 5.6: Ratio of Uncontrolled Peak Discharge to Controlled Peak Discharge

(Source: Atlanta Regional Commission, 2001)

5.4.8 Step 8: Calculate the Ratio of the Required Storage Volume to the Stormwater Runoff Volume

The value of the ratio of the required storage volume to the stormwater runoff volume (V_s/V_r) can be determined using knowledge about the rainfall distribution on the development site (e.g., Type II, Type III) (Figure 5.5) and Figure 5.7.

When determining the amount of storage needed to provide 24 hours of extended detention for the stormwater runoff volume generated by the 1-year, 24-hour storm event, the ratio of the required storage volume to the stormwater runoff volume (V_s/V_r) can also be calculated numerically for a Type II or Type III rainfall distribution (Harrington, 1987):

$$V_s/V_r = 0.683 - (1.43)(q_o/q_i) + (1.64)(q_o/q_i)^2 - (0.804)(q_o/q_i)^3$$

Where:

V_s = required storage volume (acre-feet)

V_r = stormwater runoff volume (acre-feet)

q_o = controlled peak discharge (cubic feet per second)

q_i = uncontrolled peak discharge (cubic feet per second)

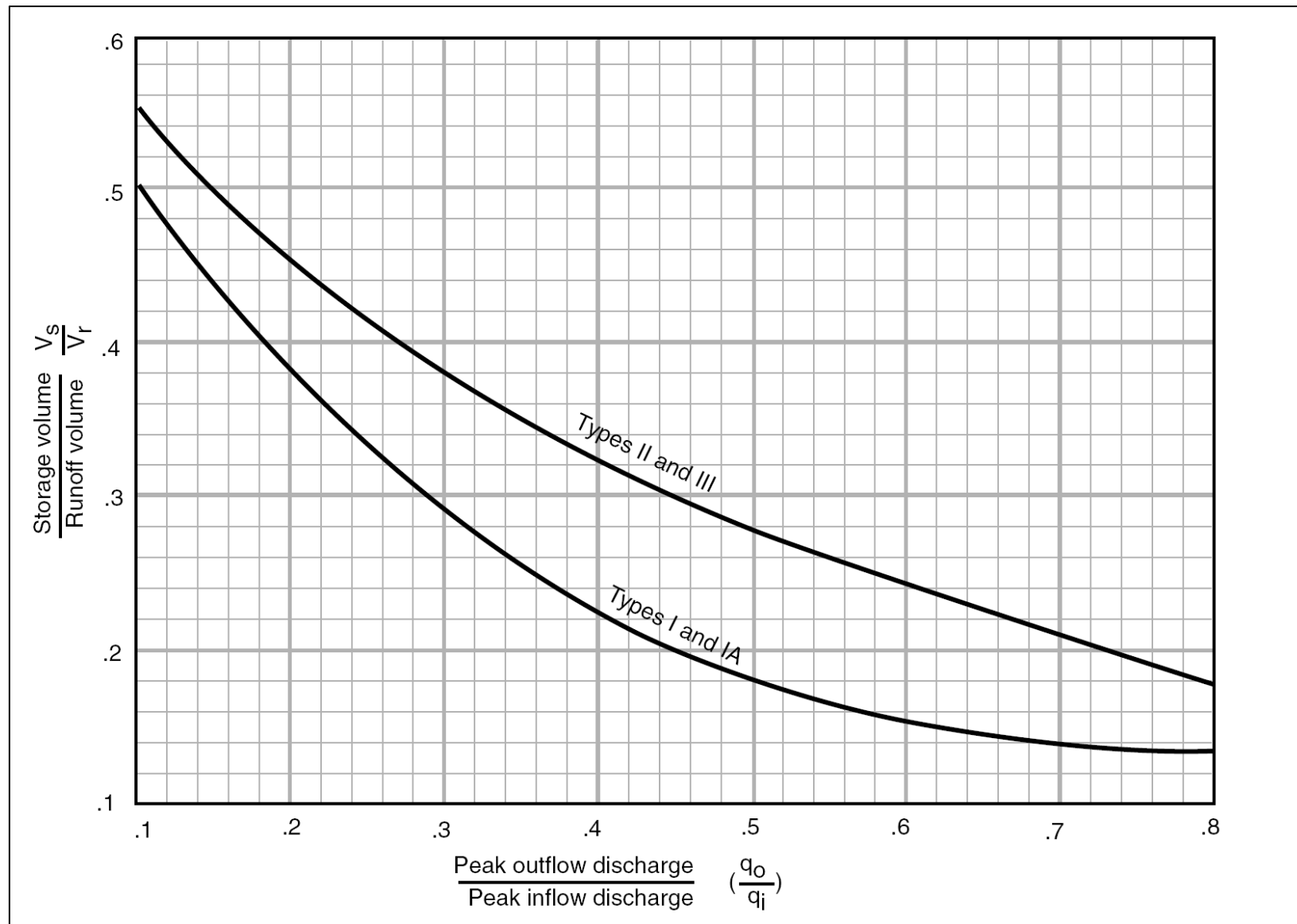

Figure 5.7: Approximate Detention Basin Routing for NRCS (SCS) Type I, IA, III and III Rainfall Distributions
 (Source: Natural Resources Conservation Service, 1986)

5.4.9 Step 9: Determine the Required Storage Volume

The final step in the procedure is to determine the amount of storage needed to provide 24 hours of extended detention for the stormwater runoff volume generated by the 1-year, 24-hour storm event. The required storage volume can be determined using the previously obtained value of V_s/V_r (Section 5.4.8) and the following equation:

$$V_s = (V_s/V_r)(V_r)$$

Where:

- V_s = required storage volume (acre-feet)
- V_r = stormwater runoff volume (acre-feet)

The stormwater runoff volume generated by the 1-year, 24-hour storm event under post development conditions (V_r) can be computed using the following equation:

$$V_r = \frac{(Q)(A)}{12}$$

Where:

- Q = stormwater runoff volume (inches)
- A = site area (acres)
- 12 = unit conversion factor (in./ft.)

Additional Information

Additional information about calculating the stormwater runoff volume associated with the aquatic resource protection criteria (SWM Criteria #3) is provided below:

- Hydrograph Generation: SCS hydrograph generation methods (NRCS, 1986) can be used to develop hydrographs for the stormwater runoff generated by the 1-year, 24-hour storm event on a development site. These methods are described in TR-55 (NRCS, 1986) and Section 2.1 of Volume 2 of the *Georgia Stormwater Management Manual* (ARC, 2001).
- Multiple Drainage Areas: When a development site contains or is divided into multiple drainage areas, it is *recommended* that ARP_v be calculated and addressed separately within each drainage area.
- Off-Site Drainage Areas: Stormwater runoff from off-site drainage areas may be diverted and conveyed around a development site and excluded from the ARP_v calculations. Alternatively, off-site stormwater runoff may be routed through the on-site post-construction stormwater management system. Off-site stormwater runoff that is routed through an on-site post-construction stormwater management system should be modeled according to "existing conditions."

5.5 Calculating the Stormwater Runoff Volume Associated with the Overbank Flood Protection Criteria (SWM Criteria #4)

An estimate of the amount of storage needed to ensure that the peak discharge generated by the 25-year, 24-hour storm event under post-development conditions, which is known as the overbank peak discharge (Q_{p25}), does not exceed the peak discharge generated by the same

storm event under pre-development conditions, can be obtained using the fourteen-step procedure outlined in Table 5.9. This procedure involves using the Graphical Peak Discharge and Storage Volume Estimation Methods presented in *Technical Release 55 (TR-55)* (NRCS, 1986). Although the procedure outlined below can be used to estimate the amount of storage needed to attenuate the overbank peak discharge (Q_{p25}), standard storage routing procedures should be used to conduct the final design of any post-construction stormwater management system used on a development site.

Table 5.9: Calculating the Stormwater Runoff Volume Associated with the Overbank Flood Protection Criteria	
Step	Description
Step 1	Determine the Amount of Rainfall Generated by the 25-Year, 24-Hour Storm Event The amount of rainfall generated by the 25-year, 24-hour storm event varies depending on the location of the development site within the 24-county coastal region. It can be determined using the rainfall tables for Brunswick and Savannah provided in Appendix A of Volume 2 of the <i>Georgia Stormwater Management Manual</i> (ARC, 2001).
Pre-Development Hydrologic Conditions	
Step 2	Determine the Runoff Curve Number for the Development Site Under Pre-Development Conditions The procedures used to determine the runoff curve number (CN) for a development site under pre-development conditions are described in Section 5.4.2.
Step 3	Compute the Stormwater Runoff Volume Generated by the 25-Year, 24-Hour Storm Event Under Pre-Development Conditions The procedures used to compute the stormwater runoff volume generated by the 25-year, 24-hour storm event under pre-development conditions are described in Section 5.4.3.
Step 4	Determine the Initial Abstraction and Initial Abstraction Ratio Under Pre-Development Conditions The procedures used to determine the initial abstraction (I_a) and initial abstraction ratio (I_a/P) under pre-development conditions are described in Section 5.4.4.
Step 5	Determine the Time of Concentration for the Development Site Under Pre-Development Conditions The procedures used to determine the time of concentration (T_c) for a development site under pre-development conditions are described in Section 5.4.5.
Step 6	Compute the Peak Discharge Under Pre-Development Conditions The procedures used to compute the peak discharge (q_o) for a development site under pre-development conditions are described in Section 5.4.6.
Post-Development Hydrologic Conditions	
Step 7	Determine the Runoff Curve Number for the Development Site Under Post-Development Conditions The procedures used to determine the runoff curve number (CN) for a development site under post-development conditions are described in Section 5.4.2.
Step 8	Compute the Stormwater Runoff Volume Generated by the 25-Year, 24-Hour Storm Event Under Post-Development Conditions The procedures used to compute the stormwater runoff volume generated by the 25-year, 24-hour storm event under post-development conditions are described in Section 5.4.3.
Step 9	Determine the Initial Abstraction and Initial Abstraction Ratio Under Post-Development Conditions The procedures used to determine the initial abstraction (I_a) and initial abstraction ratio (I_a/P) under post-development conditions are described in Section 5.4.4.
Step 10	Determine the Time of Concentration for the Development Site Under Post-Development Conditions The procedures used to determine the time of concentration (T_c) for a development site under post-development conditions are described in Section 5.4.5.
Step 11	Compute the Uncontrolled Peak Discharge Under Post-Development Conditions The procedures used to compute the uncontrolled peak discharge (q_i) for a development site under post-development conditions are described in Section 5.4.6.
Storage Volume Estimation	
Step 12	Determine the Ratio of the Pre-Development Peak Discharge to the Post-Development Peak Discharge The value of the ratio of the pre-development peak discharge to the post-development peak discharge (q_o/q_i) can be determined simply by dividing the pre-development peak discharge (q_o) (Step 6) by the uncontrolled post-development peak discharge (q_i) (Step 11).
Step 13	Calculate the Ratio of the Required Storage Volume to the Stormwater Runoff Volume The value of the ratio of required storage volume to the stormwater runoff volume (V_s/V_r) can be determined by using the ratio of the pre-development peak discharge to the uncontrolled post-development peak discharge (q_o/q_i) (Step 12) and Figure 5.7.

Table 5.9: Calculating the Stormwater Runoff Volume Associated with the Overbank Flood Protection Criteria	
Step	Description
Step 14	<p>Determine the Required Storage Volume</p> <p>The final step in the procedure is to determine the amount of storage needed to ensure that the peak discharge generated by the 25-year, 24-hour storm event under post-development conditions does not exceed the peak discharge generated by the same storm event under pre-development conditions. The required storage volume can be determined using the previously obtained value of V_s/V_r (Step 13) and the following equation:</p> $V_s = (V_s/V_r)(V_r)$ <p>Where:</p> <ul style="list-style-type: none"> V_s = required storage volume (acre-feet) V_r = stormwater runoff volume (acre-feet) <p>The stormwater runoff volume generated by the 25-year, 24-hour storm event under post development conditions (V_r) can be computed using the following equation:</p> $V_r = (Q)(A) \div 12$ <p>Where:</p> <ul style="list-style-type: none"> Q = stormwater runoff volume (inches) A = site area (acres) 12 = unit conversion factor (in./ft.)

Additional Information

Additional information about calculating the stormwater runoff volume associated with the overbank flood protection criteria (SWM Criteria #4) is provided below:

- **Hydrograph Generation:** SCS hydrograph generation methods (NRCS, 1986) can be used to develop hydrographs for the stormwater runoff generated by the 25-year, 24-hour storm event on a development site. These methods are described in TR-55 (NRCS, 1986) and Section 2.1 of Volume 2 of the *Georgia Stormwater Management Manual* (ARC, 2001).
- **Multiple Drainage Areas:** When a development site contains or is divided into multiple drainage areas, it is *recommended* that Q_{p25} be calculated and addressed separately within each drainage area.
- **Off-Site Drainage Areas:** Stormwater runoff from off-site drainage areas may be diverted and conveyed around a development site and excluded from the Q_{p25} calculations. Alternatively, off-site stormwater runoff may be routed through the on-site post-construction stormwater management system. Off-site stormwater runoff that is routed through an on-site post-construction stormwater management system should be modeled according to "existing conditions."

5.6 Calculating the Stormwater Runoff Volume Associated with the Extreme Flood Protection Criteria (SWM Criteria #5)

An estimate of the amount of storage needed to ensure that the peak discharge generated by the 100-year, 24-hour storm event under post-development conditions, which is known as the extreme peak discharge (Q_{p100}), does not exceed the peak discharge generated by the same storm event under pre-development conditions, can be obtained using the fourteen-step procedure outlined in Table 5.10. This procedure involves using the Graphical Peak Discharge and Storage Volume Estimation Methods presented in *Technical Release 55* (TR-55) (NRCS, 1986). Although the procedure outlined below can be used to estimate the amount of storage

needed to attenuate the extreme peak discharge (Q_{p100}), standard storage routing procedures should be used to conduct the final design of any post-construction stormwater management system on a development site.

Table 5.10: Calculating the Stormwater Runoff Volume Associated with the Extreme Flood Protection Criteria	
Step	Description
Step 1	Determine the Amount of Rainfall Generated by the 25-Year, 24-Hour Storm Event The amount of rainfall generated by the 100-year, 24-hour storm event varies depending on the location of the development site within the 24-county coastal region. It can be determined using the rainfall tables for Brunswick and Savannah provided in Appendix A of Volume 2 of the <i>Georgia Stormwater Management Manual</i> (ARC, 2001).
Pre-Development Hydrologic Conditions	
Step 2	Determine the Runoff Curve Number for the Development Site Under Pre-Development Conditions The procedures used to determine the runoff curve number (CN) for a development site under pre-development conditions are described in Section 5.4.2.
Step 3	Compute the Stormwater Runoff Volume Generated by the 100-Year, 24-Hour Storm Event Under Pre-Development Conditions The procedures used to compute the stormwater runoff volume generated by the 100-year, 24-hour storm event under pre-development conditions are described in Section 5.4.3.
Step 4	Determine the Initial Abstraction and Initial Abstraction Ratio Under Pre-Development Conditions The procedures used to determine the initial abstraction (I_a) and initial abstraction ratio (I_a/P) under pre-development conditions are described in Section 5.4.4.
Step 5	Determine the Time of Concentration for the Development Site Under Pre-Development Conditions The procedures used to determine the time of concentration (T_c) for a development site under pre-development conditions are described in Section 5.4.5.
Step 6	Compute the Peak Discharge Under Pre-Development Conditions The procedures used to compute the peak discharge (q_o) for a development site under pre-development conditions are described in Section 5.4.6.
Post-Development Hydrologic Conditions	
Step 7	Determine the Runoff Curve Number for the Development Site Under Post-Development Conditions The procedures used to determine the runoff curve number (CN) for a development site under post-development conditions are described in Section 5.4.2.
Step 8	Compute the Stormwater Runoff Volume Generated by the 100-Year, 24-Hour Storm Event Under Post-Development Conditions The procedures used to compute the stormwater runoff volume generated by the 100-year, 24-hour storm event under post-development conditions are described in Section 5.4.3.
Step 9	Determine the Initial Abstraction and Initial Abstraction Ratio Under Post-Development Conditions The procedures used to determine the initial abstraction (I_a) and initial abstraction ratio (I_a/P) under post-development conditions are described in Section 5.4.4.
Step 10	Determine the Time of Concentration for the Development Site Under Post Development Conditions The procedures used to determine the time of concentration (T_c) for a development site under post-development conditions are described in Section 5.4.5.
Step 11	Compute the Uncontrolled Peak Discharge Under Post-Development Conditions The procedures used to compute the uncontrolled peak discharge (q_i) for a development site under post-development conditions are described in Section 5.4.6.
Storage Volume Estimation	
Step 12	Determine the Ratio of the Pre-Development Peak Discharge to the Post-Development Peak Discharge The value of the ratio of the pre-development peak discharge to the post-development peak discharge (q_o/q_i) can be determined simply by dividing the pre-development peak discharge (q_o) (Step 6) by the uncontrolled post-development peak discharge (q_i) (Step 11).
Step 13	Calculate the Ratio of the Required Storage Volume to the Stormwater Runoff Volume The value of the ratio of required storage volume to the stormwater runoff volume (V_s/V_r) can be determined by using the ratio of the pre-development peak discharge to the uncontrolled post-development peak discharge (q_o/q_i) (Step 12) and Figure 5.7.

Table 5.10: Calculating the Stormwater Runoff Volume Associated with the Extreme Flood Protection Criteria	
Step	Description
Step 14	<p>Determine the Required Storage Volume</p> <p>The final step in the procedure is to determine the amount of storage needed to ensure that the peak discharge generated by the 100-year, 24-hour storm event under post-development conditions does not exceed the peak discharge generated by the same storm event under pre-development conditions. The required storage volume can be determined using the previously obtained value of V_s/V_r (Step 13) and the following equation:</p> $V_s = (V_s/V_r)(V_r)$ <p>Where:</p> <ul style="list-style-type: none"> V_s = required storage volume (acre-feet) V_r = stormwater runoff volume (acre-feet) <p>The stormwater runoff volume generated by the 100-year, 24-hour storm event under post development conditions (V_r) can be computed using the following equation:</p> $V_r = (Q)(A) \div 12$ <p>Where:</p> <ul style="list-style-type: none"> Q = stormwater runoff volume (inches) A = site area (acres) 12 = unit conversion factor (in./ft.)

Additional Information

Additional information about calculating the stormwater runoff volume associated with the extreme flood protection criteria (SWM Criteria #5) is provided below:

- **Hydrograph Generation:** SCS hydrograph generation methods (NRCS, 1986) can be used to develop hydrographs for the stormwater runoff generated by the 100-year, 24-hour storm event on a development site. These methods are described in TR-55 (NRCS, 1986) and Section 2.1 of Volume 2 of the *Georgia Stormwater Management Manual* (ARC, 2001).
- **Multiple Drainage Areas:** When a development site contains or is divided into multiple drainage areas, it is *recommended* that Q_{p100} be calculated and addressed separately within each drainage area.
- **Off-Site Drainage Areas:** Stormwater runoff from off-site drainage areas may be diverted and conveyed around a development site and excluded from the Q_{p100} calculations. Alternatively, off-site stormwater runoff may be routed through the on-site post-construction stormwater management system. Off-site stormwater runoff that is routed through an on-site post-construction stormwater management system should be modeled according to "existing conditions."

References

- Atlanta Regional Commission (ARC). 2001. *Georgia Stormwater Management Manual*. Volume 2. Technical Handbook. Atlanta Regional Commission. Atlanta, GA. Available Online: <http://www.georgiastormwater.com/>.
- Brakensiek, D.L. and W.J. Rawls. 1983. "Green-Ampt Infiltration Model Parameters for Hydrologic Classification of Soils." *Advances in Irrigation and Drainage Surviving External Pressures*. J. Borrelli, V.R. Hasfurther and R.D. Burman (Eds.). Proceedings of the American Society of Civil Engineers Engineering Specialty Conference. New York, NY.
- Engman, E.T. 1986. "Roughness Coefficients for Routing Surface Runoff." *Journal of Irrigation and Drainage Engineering*. 112(1): 39-53.
- Harrington, B. 1987. *Design Procedures for Stormwater Management Extended Detention Structures*. Prepared for: Maryland Department of Natural Resources. Water Resources Administration. Annapolis, MD.
- Natural Resources Conservation Service (NRCS). 1986. *Urban Hydrology for Small Watersheds*. Technical Release 55. U.S. Department of Agriculture. Natural Resources Conservation Service. Conservation Engineering Division. Washington, DC.
- Natural Resources Conservation Service (NRCS). 1985. "Section 4: Hydrology." *National Engineering Handbook*. U.S. Department of Agriculture. Natural Resources Conservation Service. Washington, DC.
- Natural Resources Conservation Service (NRCS). 1964. "Section 4: Hydrology." *National Engineering Handbook*. U.S. Department of Agriculture. Natural Resources Conservation Service. Washington, DC.
- Ocean County Soil Conservation District (OCSCD). 2001. *Impact of Soil Disturbance During Construction on Bulk Density and Infiltration in Ocean County, New Jersey*. Ocean County Soil Conservation District. Forked River, NJ. Available Online: <http://www.ocscd.org/soil.pdf>.
- Overton, D.E. and M.E. Meadows. 1976. *Storm Water Modeling*. Academic Press. New York, NY.
- Schueler, T. 1987. *Controlling Urban Runoff: A Practical Manual for Planning and Designing Urban BMPs*. Metropolitan Washington Council of Governments. Department of Environmental Programs. Washington, DC.

6.0 Satisfying the Stormwater Management and Site Planning and Design Criteria

6.1 Overview

Section 4.0 presented a comprehensive set of post-construction stormwater management and site planning and design criteria that can be applied to new development and redevelopment activities occurring within the Coastal Nonpoint Source Management Area and Area of Special Interest. Satisfying these criteria requires the successful *integration* of natural resource protection and stormwater management with the site planning and design process (Figure 6.1).

This *integration* can be accomplished through the use of an approach to the site planning and design process that: (1) identifies and protects valuable natural resources; (2) limits land disturbance and the creation of new impervious and disturbed pervious cover; and (3) reduces and manages post-construction stormwater runoff rates, volumes and pollutant loads. This approach involves the use of two distinct, but complementary groups of natural resource protection and stormwater management techniques:

- Green Infrastructure Practices: Natural resource protection and stormwater management practices and techniques (i.e., better site planning and design techniques, low impact development practices) that can be used to help *prevent* increases in post-construction stormwater runoff rates, volumes and pollutant loads.
- Stormwater Management Practices: Stormwater management practices (e.g., wet ponds, swales) that can be used to *manage* post-construction stormwater runoff rates, volumes and pollutant loads.

The use of these natural resource protection and stormwater management techniques helps control and minimize the negative impacts of the land development process while retaining and, perhaps, even enhancing a developer's vision for a development site. When applied during the site planning and design process, they can be used to create more natural and aesthetically pleasing development projects and create more cost-effective post-construction stormwater management systems (ARC, 2001). The use of these techniques, particularly the green infrastructure practices, can even reduce overall development costs while maintaining or increasing the resale value of a development project (MacMullan and Reich, 2007, US EPA, 2007, Winer-Skonovd et al., 2006).

This Section of the Coastal Stormwater Supplement (CSS) provides information about using these natural resource protection and stormwater management techniques during the site planning and design process (Figure 6.1). In doing so, it provides guidance on an integrated, green infrastructure-based

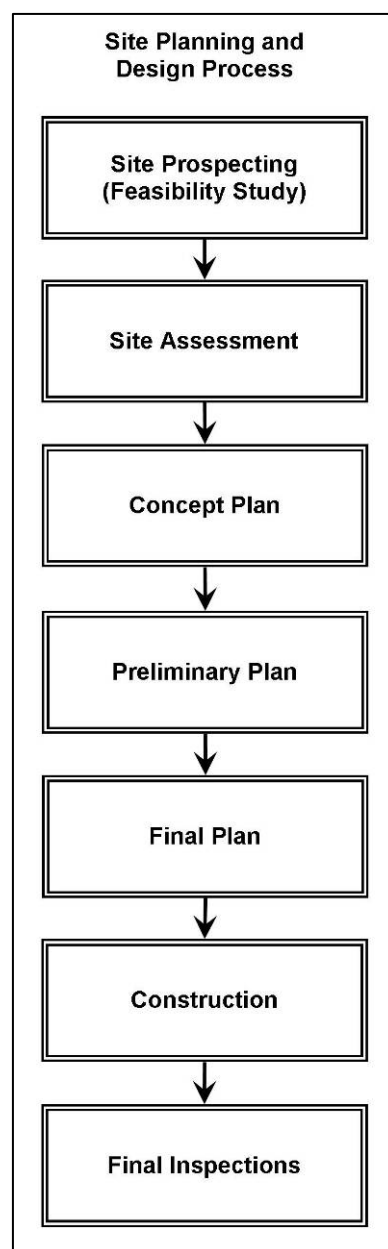

Figure 6.1: Site Planning and Design Process
(Source: Center for Watershed Protection)

approach to natural resource protection, stormwater management and site design that can be used to satisfy the stormwater management and site planning and design criteria presented in this CSS.

6.2 Site Planning and Design Process

Figure 6.1 depicts the site planning and design process that is typically used throughout coastal Georgia. Each phase of this process is briefly described below:

- **Site Prospecting:** During the site prospecting phase, some basic information is used to evaluate the feasibility of completing a development or redevelopment project. A *feasibility study* is typically used to evaluate the many factors that influence a developer's decision about whether or not to move forward with a potential development project. Factors that are typically evaluated during a *feasibility study* include information about site characteristics and constraints, applicable local, state and federal stormwater management and site planning and design requirements, adjacent land uses and access to local infrastructure (e.g., water, sanitary sewer).
- **Site Assessment:** Once a potential development or redevelopment project has been deemed feasible, a more thorough assessment of the development site is completed. The site assessment, which is typically completed using acceptable site reconnaissance and surveying techniques, provides additional information about a development site's characteristics and constraints. Once the assessment is complete, a developer can identify and analyze the natural, man-made, economic and social aspects of a potential development project, define the actual buildable area available on the development site and begin making some preliminary decisions about the layout of the proposed development project.
- **Concept Plan:** The results of the site assessment are typically used to create a concept plan (also known as a *sketch plan*) for the proposed development project. A concept plan is used to illustrate the basic layout of the proposed development project, including lots and roadways, and is usually reviewed with the local development review authority before additional resources are used to create a more detailed plan of development. During this phase, several alternative concept plans can be created and compared with one another to craft a plan of development that best "fits" the character of the development site (Figures 6.2-6.4).
- **Preliminary Plan:** A preliminary plan presents a more detailed layout of a proposed development project. It typically includes information about lots, buildings, roadways, parking areas, sidewalks, conservation areas, utilities and other infrastructure, including the post-construction stormwater management system. After the preliminary plan has been reviewed and approved by the local development review authority, a final plan may be prepared. There may be several iterations of the preliminary plan between the time that it is submitted and the time that it is approved by the local development review authority.
- **Final Plan:** The final plan adds further detail to the preliminary plan and reflects any changes to the plan of development that were requested or required by the local development review authority. The final plan typically includes all of the information that was included in the preliminary plan, as well as information about landscaping, pollution prevention, erosion and sediment control and long-term operation and maintenance of the site's post-construction stormwater management system. There may be several

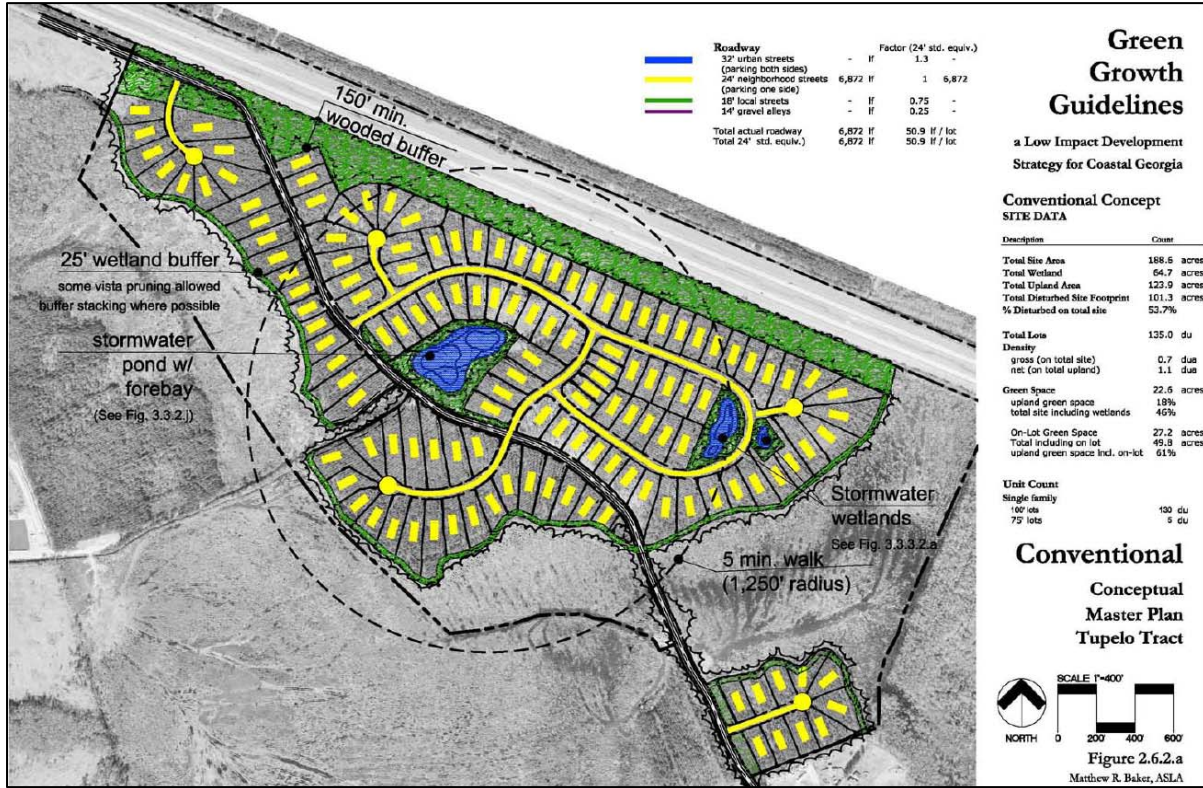

Figure 6.2: Conventional Site Design
(Source: Merrill et al., 2006)

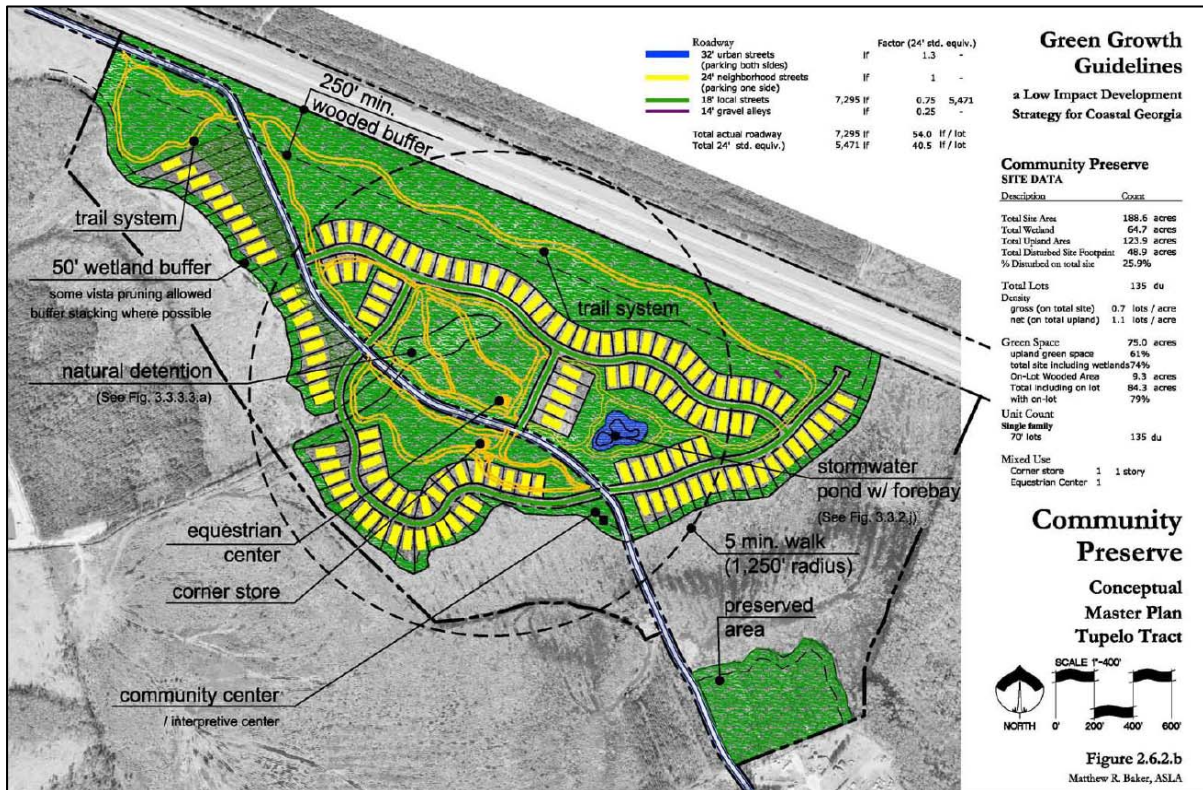

Figure 6.3: Conservation Site Design
(Source: Merrill et al., 2006)

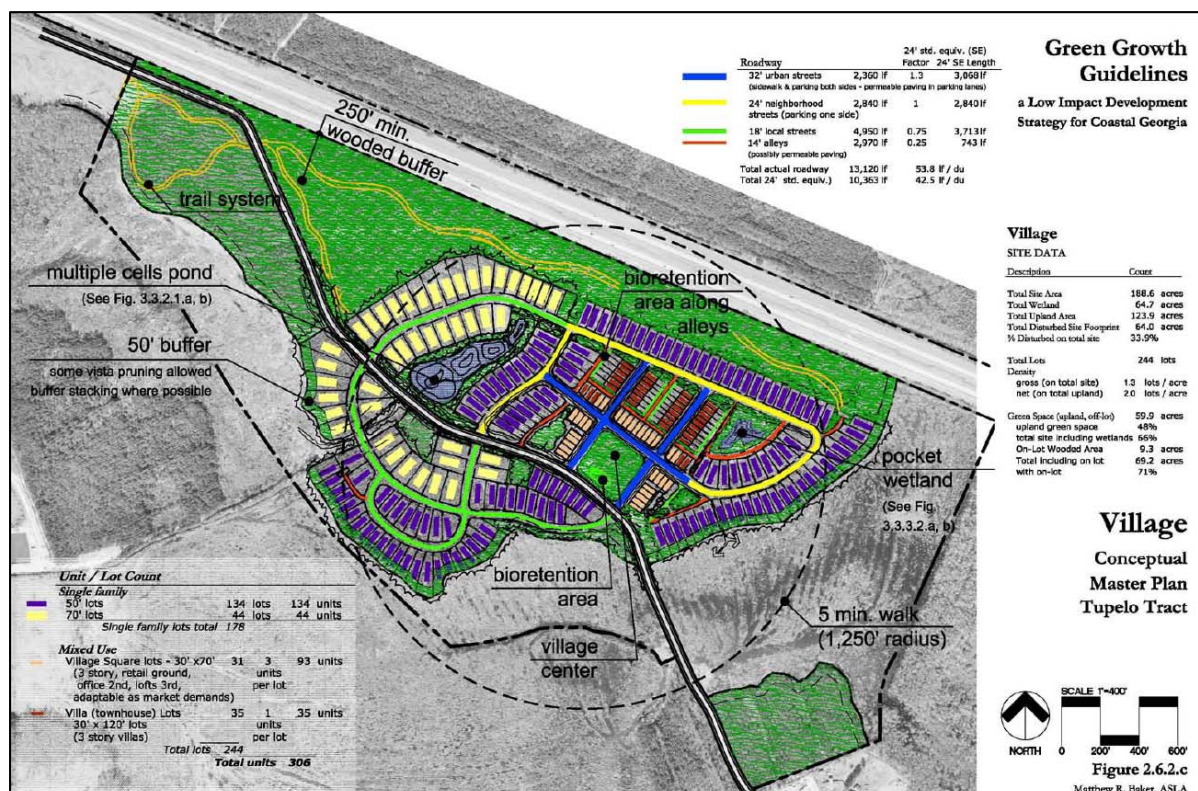

Figure 6.4: New Urbanist Site Design

(Source: Merrill et al., 2006)

iterations of the final plan between the time that it is submitted and the time that it is approved by the local development review authority.

- **Construction:** Once the final plan has been reviewed and approved, performance bonds are set and placed, contractors are retained and construction begins. During the construction phase, a development project may be inspected on a regular basis by the local development review authority to ensure that all roadways, parking areas, buildings, utilities and other infrastructure, including the post-construction stormwater management system, are being built in accordance with the approved final plan and that all primary and secondary conservation areas have been protected from any land disturbing activities.
- **Final Inspections:** Once construction is complete, final inspections take place to ensure that all roadways, parking areas, buildings, utilities and other infrastructure, including the post-construction stormwater management system, were built according to the approved final plan. As-built plans are also typically prepared and executed during this phase. If a development project passes all final inspections, an occupancy permit may be issued for the project.

6.3 Integrating Natural Resource Protection and Stormwater Management with the Site Planning and Design Process

In order to successfully *integrate* natural resource protection and stormwater management with the site planning and design process, site planning and design teams are encouraged to consider following questions at the beginning of the process:

- What valuable natural resources, both terrestrial and aquatic, can be found on the development site?
- How can better site planning techniques be used to protect these valuable natural resources from the direct impacts of the land development process?
- How can better site design techniques be used to minimize land disturbance and the creation of new impervious and disturbed pervious cover?
- What low impact development practices can be used to help preserve pre-development site hydrology and *reduce* post-construction stormwater runoff rates, volumes and pollutant loads?
- What stormwater management practices can be used to *manage* post-construction stormwater runoff rates, volumes and pollutant loads?
- Are there any site characteristics or constraints that prevent the use of any particular low impact development or stormwater management practices on the development site?

Although answering these questions is no easy task (i.e., answering these questions typically requires a solid understanding a development site's characteristics and constraints), answers to all of these questions can be readily obtained within the context of the six-step *stormwater management planning and design process* outlined below:

- Step 1: Pre-Application Meeting
- Step 2: Review of Local, State and Federal Stormwater Management and Site Planning and Design Requirements
- Step 3: Natural Resources Inventory
- Step 4: Prepare Stormwater Management Concept Plan
 - Step 4.1: Use Better Site Planning Techniques
 - Step 4.2: Use Better Site Design Techniques
 - Step 4.3: Calculate Stormwater Management Criteria
 - Step 4.4: Apply Low Impact Development Practices
 - Step 4.5: Check To See If Stormwater Management Criteria Have Been Met
 - Step 4.6: Apply Stormwater Management Practices
 - Step 4.7: Check To See If Stormwater Management Criteria Have Been Met
 - Step 4.8: Finalize Stormwater Management Concept Plan
- Step 5: Consultation Meeting
- Step 6: Prepare Stormwater Management Design Plan

Each step in this *stormwater management planning and design process* corresponds to a particular phase of the overall site planning and design process (Figure 6.5). Consequently, it can be used to *integrate* natural resource protection and stormwater management with the site planning and design process and to satisfy the stormwater management and site planning and design criteria presented in this CSS.

Each step in the *stormwater management planning and design process* is described in more detail below.

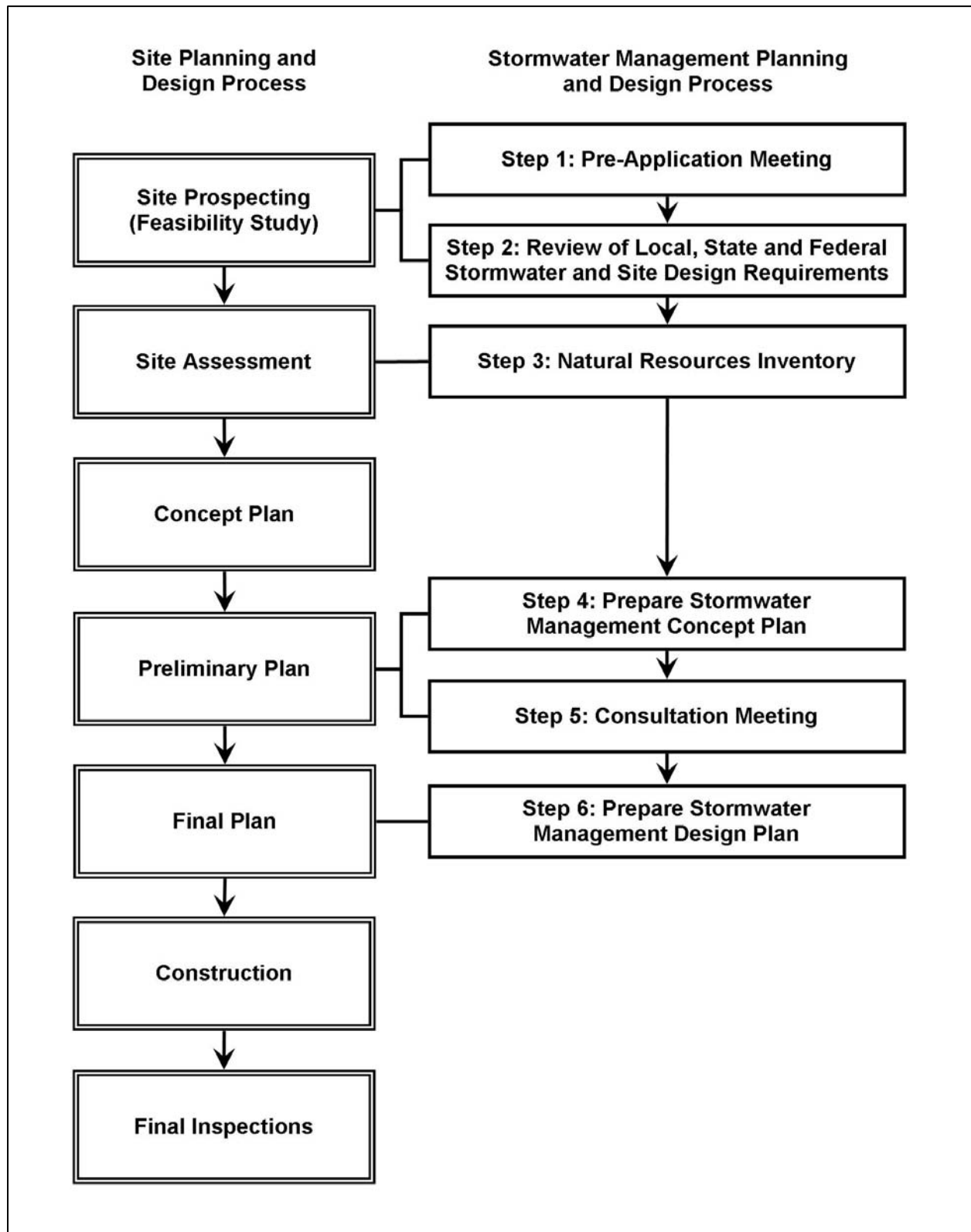

Figure 6.5: Integrating Natural Resource Protection and Stormwater Management with the Site Planning and Design Process

(Source: Center for Watershed Protection)

6.3.1 Step 1: Pre-Application Meeting

It is *recommended* that a pre-application meeting between the site planning and design team and the local development review authority occur at the very beginning of the *stormwater management planning and design process*. This meeting, which should occur during the site prospecting phase of the overall site planning and design process (Figure 6.5), helps establish a relationship between the site planning and design team and the local development review authority. The pre-application meeting also provides an opportunity to discuss the local stormwater management and site planning and design criteria that will apply to the proposed development project, which increases the likelihood that the remainder of the site planning and design process will proceed both quickly and smoothly. If representatives from the appropriate state and federal agencies are able to attend the meeting, it can also be used to discuss the state and federal regulations (e.g., Coastal Marshlands Protection Act, Georgia Erosion and Sediment Control Act, Clean Water Act, Endangered Species Act) that will apply to the development project.

If a joint site visit can be conducted as part of the meeting, the pre-application meeting can also be used to identify and discuss potential natural resource protection and stormwater management strategies. By walking the site together, the site planning and design team and representatives of the local development review authority can identify potential site constraints, delineate potential primary and secondary conservation areas and define general expectations for the rest of the site planning and design process.

6.3.2 Step 2: Review of Local, State and Federal Stormwater Management and Site Planning and Design Requirements

Once a pre-application meeting has been completed, it is *recommended* that the site planning and design team review the local, state and federal stormwater management and site planning and design requirements that will apply to the proposed development project. This review should occur during the site prospecting phase of the overall site planning and design process (Figure 6.5), while the *feasibility study* is still being completed.

The stormwater management and site planning and design requirements that apply to a particular development project may include the stormwater management and site planning and design criteria presented in this CSS, as well as the requirements spelled out in other local, state and federal regulations (e.g., local zoning ordinances, local subdivision ordinances, Coastal Marshlands Protection Act, Georgia Erosion and Sediment Control Act). Typically, information about the local stormwater management and site planning and design requirements that will apply to a particular development project can be obtained directly from a review of local codes and ordinances or from discussions with representatives of the local development review authority. These discussions can be held during the pre-application meeting (Section 6.3.1). Information about the state and federal requirements that apply to a proposed development project can be obtained from agency websites or from discussions with representatives of the appropriate state and federal agencies.

During their review of stormwater management and site planning and design requirements, site planning and design teams should also investigate opportunities and incentives for land conservation, such as those offered through the Georgia Land Conservation Program (i.e., tax incentives for donations of conserved lands or conservation easements), and opportunities and incentives for *conservation development* (Box 6.1).

Box 6.1: Conservation Development

Conservation development, also known as *open space development* or *cluster development*, is a site planning and design technique used to concentrate structures and impervious surfaces in a small portion of a development site, leaving room for larger conservation areas and managed open spaces elsewhere on the site (Figure 6.6). Smaller lot sizes and alternative lot designs (Section 7.7.9) are typically used to “cluster” structures and other impervious surfaces within these conservation developments.

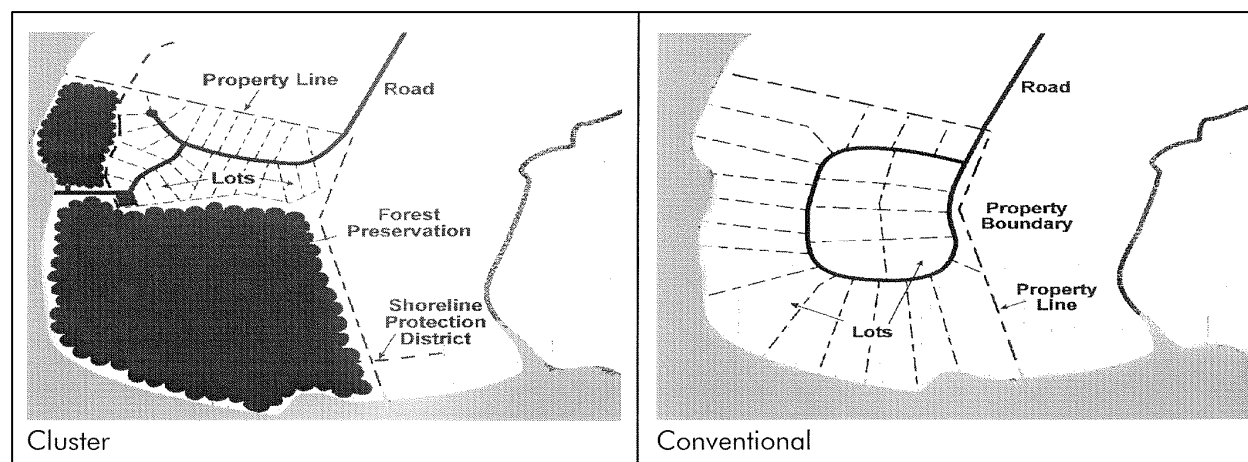

Figure 6.6: Conservation (Cluster) Development Versus Conventional Development

(Source: Center for Watershed Protection, 1998)

Conservation development projects provide a host of environmental benefits that are typically more difficult to achieve with conventional site design techniques. They provide for better natural resource protection on development sites and inherently limit increases in site imperviousness, sometimes by as much as 40 to 60 percent (CWP, 1998). Reduced site imperviousness results in reduced post-construction stormwater runoff rates, volumes and pollutant loads, which helps better protect both on-site and downstream aquatic resources from the negative impacts of the land development process. Reduced stormwater runoff rates, volumes and pollutant loads also help reduce the size of and need for storm drain systems and stormwater management practices on development sites.

As a number of recent studies have shown (MacMullan and Reich, 2007, US EPA, 2007, Winer-Skonovd et al., 2006), conservation development projects can also be significantly less expensive to build than more conventional development projects. Most of the cost savings can be attributed to the reduced amount of infrastructure (e.g., roads, sidewalks, post-construction stormwater management practices) needed on these development projects. And while these projects are frequently less expensive to build, developers often find that the lots located within conservation developments command higher prices and sell more quickly than those located within more conventional developments (ARC, 2001).

6.3.3 Step 3: Natural Resources Inventory

Once the potential development or redevelopment project has been deemed feasible, it is *recommended* that acceptable site reconnaissance and surveying techniques be used to complete a thorough assessment of the natural resources, both terrestrial and aquatic, found on the development site. The identification and subsequent preservation and/or restoration of

these natural resources helps reduce the negative impacts of the land development process “by design.” The natural resources inventory should be completed during the site assessment phase of the overall site planning and design process (Figure 6.5), in accordance with site planning and design criteria #1 (SP&D Criteria #1) (Section 4.3.1).

Once the natural resources inventory has been completed and a *site fingerprint* has been created, the site planning and design team should have a better understanding of a development site’s characteristics and constraints. This information can be used to identify primary and secondary conservation areas and define the actual buildable area available on the development site (Figure 6.7). Along with information about adjacent land uses and available infrastructure (e.g., roads, utilities), the *site fingerprint* can also be used to make some preliminary decisions about the layout of the proposed development project and to guide the creation of the stormwater management concept plan (Section 6.3.4).

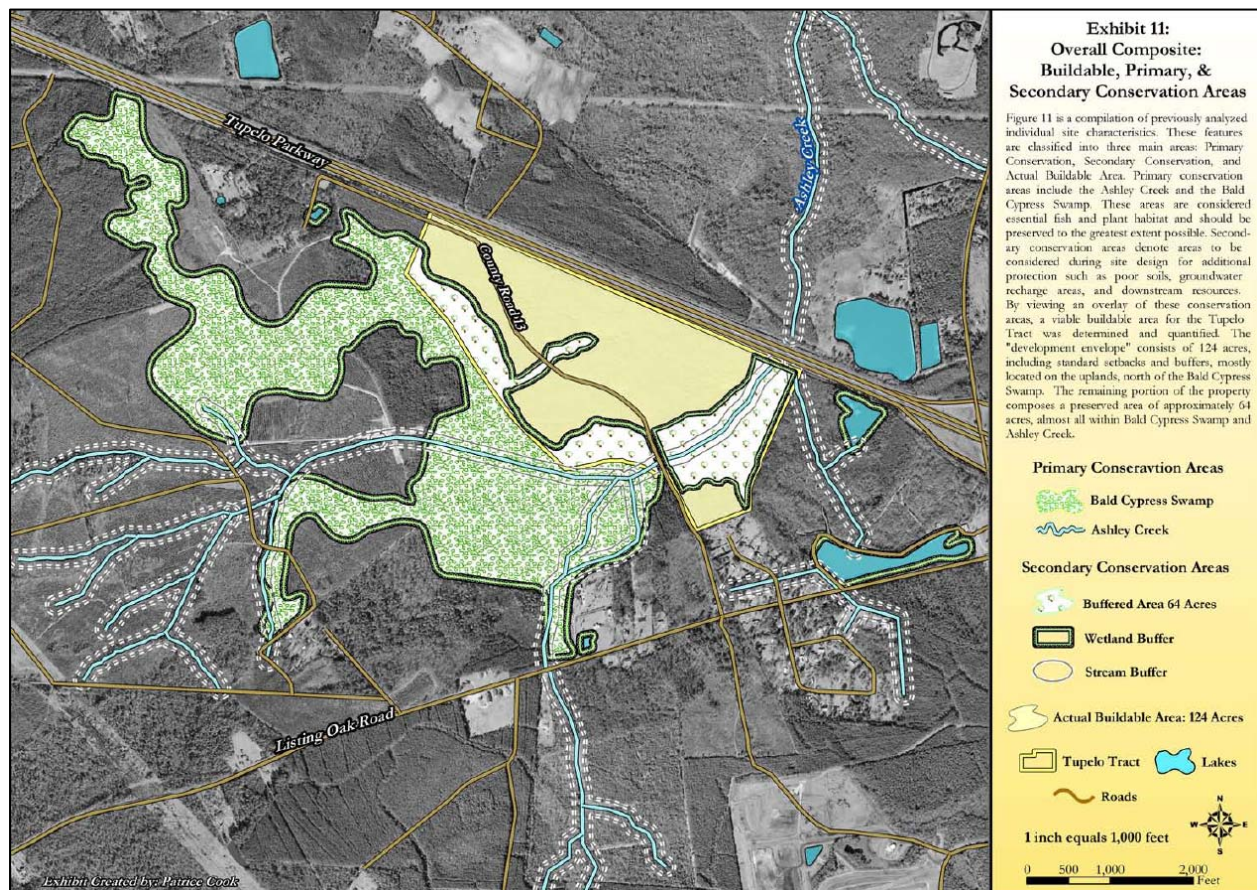

Figure 6.7: Buildable Area and Primary and Secondary Conservation Areas

(Source: Merrill et al., 2006)

Although a lot of the information needed to complete the natural resources inventory may need to be gathered through site reconnaissance and surveying, some of it may be available directly from the local development review authority, other state and federal agencies or from the internet. A comprehensive list of internet sites that act as clearinghouses for Geographic Information System (GIS) data and other spatial data, along with additional information about completing a site assessment and natural resources inventory, is provided in the *Green Growth Guidelines* (Merrill et al., 2006).

6.3.4 Step 4: Prepare Stormwater Management Concept Plan

After the natural resources inventory has been completed, it is *recommended* that the *site fingerprint* be used to develop a stormwater management concept plan for the proposed development project. In accordance with SP&D Criteria #3 (Section 4.3.3), the stormwater management concept plan should illustrate the layout of the proposed development project and should show, in general, how post-construction stormwater runoff will be managed on the development site.

The creation of a stormwater management concept plan allows the site planning and design team make to some preliminary decisions about the layout of the proposed development project. If it is submitted to the local development review authority prior to the preparation and submittal of the stormwater management design plan (Section 6.3.5), it can also be used to solicit early feedback on the project and on the green infrastructure and stormwater management practices that will be used to manage post-construction stormwater runoff on the development site.

During the creation of the stormwater management concept plan, most of the site layout, including the layout of lots, buildings, roadways, parking areas, sidewalks and green infrastructure and stormwater management practices, will be completed. Consequently, it is very important that natural resource protection and stormwater management be considered throughout this part of the *stormwater management planning and design process*. If they are not, it will be very difficult to meet the stormwater management and site planning and design criteria presented in this CSS.

To help ensure that natural resource protection and stormwater management are considered throughout this part of the *stormwater management planning and design process*, it is *recommended* that an iterative, eight-step process (Figure 6.8) be used to create a stormwater management concept plan:

- Step 4.1: Use Better Site Planning Techniques
- Step 4.2: Use Better Site Design Techniques
- Step 4.3: Calculate Stormwater Management Criteria
- Step 4.4: Apply Low Impact Development Practices
- Step 4.5: Check To See If Stormwater Management Criteria Have Been Met
- Step 4.6: Apply Stormwater Management Practices
- Step 4.7: Check To See If Stormwater Management Criteria Have Been Met
- Step 4.8: Finalize Stormwater Management Concept Plan

Each step in this iterative, eight-step process for creating a stormwater management concept plan is described in more detail below. It is important to note that this iterative site planning and design process can be completed in conjunction with the *Coastal Stormwater Supplement Site Planning and Design Worksheet*, which is available for free download from the following websites:

<http://www.gaepd.org>

<http://www.mpcnaturalresources.org>

<http://www.coastalgeorgiardc.org>.

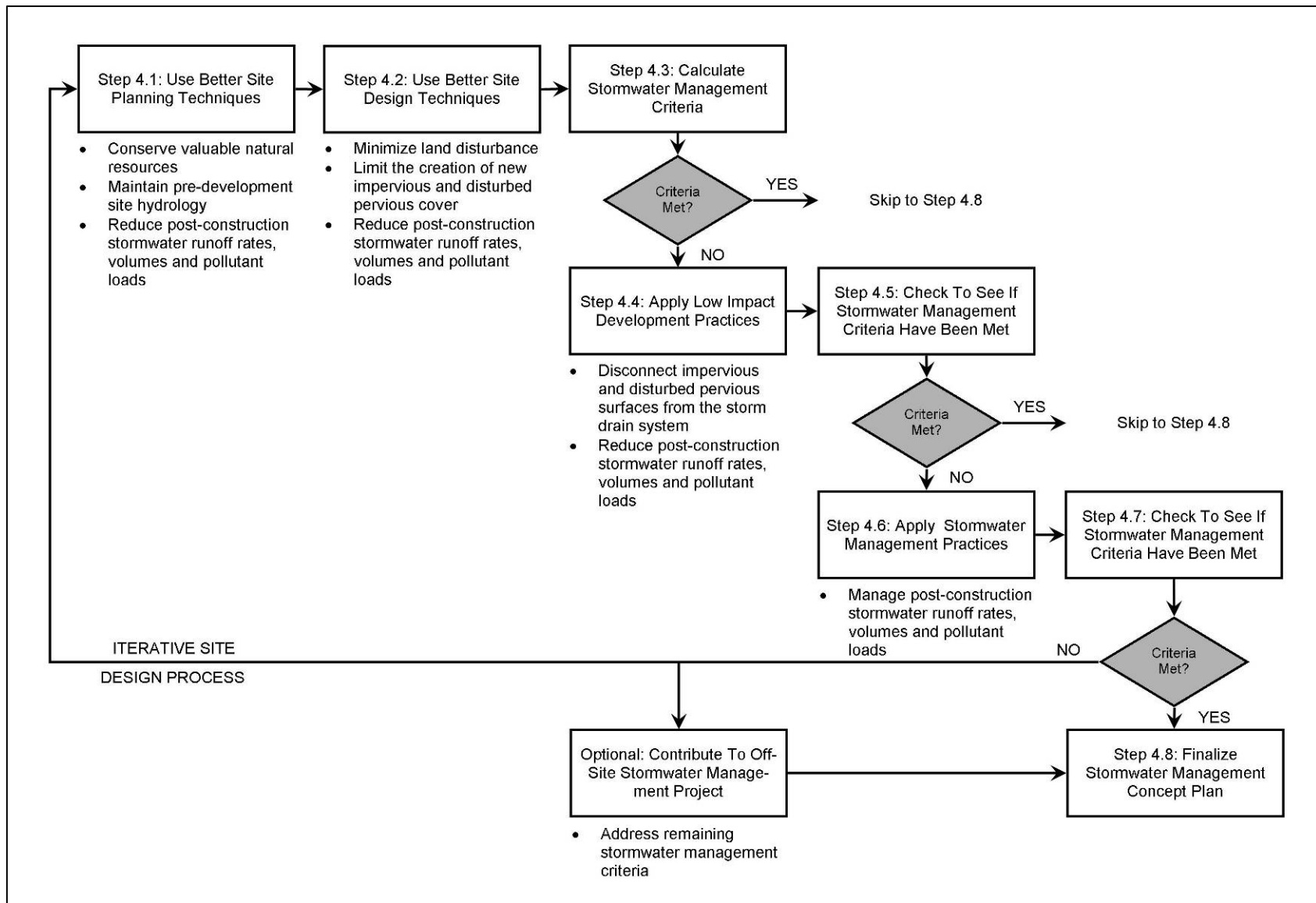

Figure 6.8: Developing a Stormwater Management Concept Plan
 (Source: Center for Watershed Protection)

6.3.4.1 Step 4.1: Use Better Site Planning Techniques

The first and, perhaps, most important step in the process of developing a stormwater management concept plan is to use better site planning techniques during the layout of the proposed development project. The better site planning techniques *recommended* for use in coastal Georgia include:

Better Site Planning Techniques

- Protect Primary Conservation Areas
- Protect Secondary Conservation Areas

The use of these better site planning techniques not only helps protect important primary and secondary conservation areas from the direct impacts of the land development process, but also helps preserve pre-development site hydrology and reduce post-construction stormwater runoff rates, volumes and pollutant loads. These better site planning techniques also provide a number of other environmental and economic benefits, including reduced land disturbance and soil erosion, improved air quality, increased carbon sequestration, improved aesthetics and improved human health (US EPA, 2008).

Applying Better Site Planning Techniques During the Site Planning & Design Process

After completing the natural resources inventory (Section 6.3.3), the site planning and design team should be able to identify the primary and secondary conservation areas found on the development site. In accordance with SP&D Criteria #2 (Section 4.3.2), it is *recommended* that:

- (1) The following primary conservation areas, which provide habitat for high priority plant and animal species (Appendix A) and are considered to be high priority habitat areas (WRD, 2005), be protected from the direct impacts of the land development process:
 - Aquatic Resources
 - Rivers
 - Perennial and Intermittent Streams
 - Freshwater Wetlands
 - Tidal Rivers and Streams
 - Tidal Creeks
 - Coastal Marshlands
 - Tidal Flats
 - Scrub-Shrub Wetlands
 - Near Coastal Waters
 - Beaches
 - Terrestrial Resources
 - Dunes
 - Maritime Forests
 - Marsh Hammocks
 - Evergreen Hammocks
 - Canebrakes
 - Bottomland Hardwood Forests
 - Beech-Magnolia Forests
 - Pine Flatwoods
 - Longleaf Pine-Wiregrass Savannas
 - Longleaf Pine-Scrub Oak Woodlands

- Other Resources
 - Aquatic Buffers
 - Shellfish Harvesting Areas
 - Other High Priority Habitat Areas
- (2) Consideration be given to protecting the following secondary conservation areas from the direct impacts of the land development process:
- General Resources
 - Natural Drainage Features (e.g., Swales, Basins, Depressional Areas)
 - Erodible Soils
 - Steep Slopes (i.e., Areas with Slopes Greater Than 15%)
 - Trees and Other Existing Vegetation
 - Aquatic Resources
 - Groundwater Recharge Areas
 - Wellhead Protection Areas
 - Other Resources
 - Floodplains

All primary and secondary conservation areas that will be protected from the direct impacts of the land development process should be clearly identified on the stormwater management concept plan (Figure 6.9). They should be maintained in an undisturbed, natural state before, during and after construction, and should be protected in perpetuity through a legally-enforceable conservation instrument (e.g., conservation easement, deed restriction). Additional information about how to apply these better site planning techniques on a development site can be found in Section 7.6.

Using Better Site Planning Techniques to Help Satisfy the Stormwater Management Criteria

Although protecting primary and secondary conservation areas can be thought of as a “self-crediting” stormwater management technique (i.e., protecting them *implicitly* reduces post-construction stormwater runoff rates, volumes and pollutant loads), it is important not to overlook the stormwater management and other environmental benefits that these better site planning techniques provide. Consequently, they have been assigned quantifiable stormwater management “credits” that can be used when calculating the stormwater runoff volumes associated with the post-construction stormwater management criteria (SWM Criteria) presented in this CSS. While Table 6.1 summarizes these “credits,” additional information about them, including information about how they can be used to help satisfy the SWM Criteria presented in this CSS, is provided in Section 7.6.

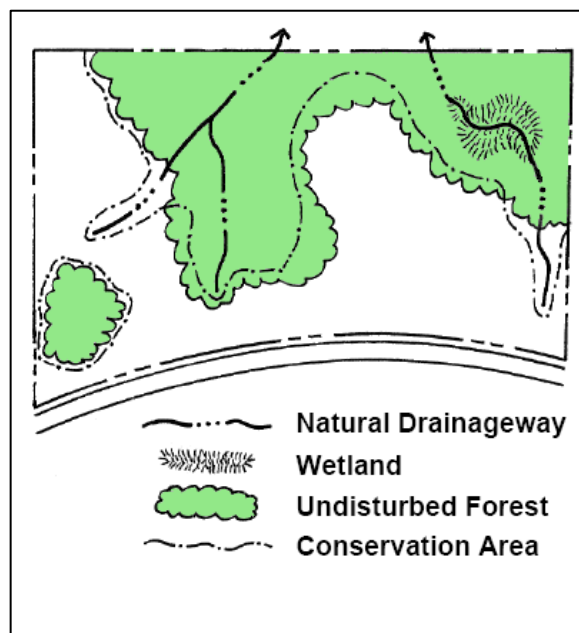

Figure 6.9: Delineation of Primary and Secondary Conservation Areas

(Source: Atlanta Regional Commission, 2001)

Table 6.1: How Better Site Planning Techniques Can Be Used To Help Satisfy the Stormwater Management Criteria

Better Site Planning Technique	Stormwater Runoff Reduction	Water Quality Protection	Aquatic Resource Protection	Overbank Flood Protection	Extreme Flood Protection
Protect Primary Conservation Areas	<p>"Credit": Subtract any <i>primary and secondary conservation areas</i> from the total site area when calculating the runoff reduction volume (RR_v) that applies to a development site.</p>	<p>"Credit": Subtract any <i>primary and secondary conservation areas</i> from the total site area when calculating the runoff reduction volume (RR_v) that applies to a development site.</p>	<p>"Credit": Assume that the post-development hydrologic conditions of any <i>primary and secondary conservation areas</i> are equivalent to the pre-development hydrologic conditions for those same areas.</p>	<p>"Credit": Assume that the post-development hydrologic conditions of any <i>primary and secondary conservation areas</i> are equivalent to the pre-development hydrologic conditions for those same areas.</p>	<p>"Credit": Assume that the post-development hydrologic conditions of any <i>primary and secondary conservation areas</i> are equivalent to the pre-development hydrologic conditions for those same areas.</p>
Protect Secondary Conservation Areas					

6.3.4.2 Step 4.2: Use Better Site Design Techniques

The next step in the process of developing a stormwater management concept plan is to use better site design techniques during the design of the proposed development project. The better site design techniques *recommended* for use in coastal Georgia include:

Better Site Design Techniques

- Reduce Clearing and Grading Limits
- Reduce Roadway Lengths and Widths
- Use Fewer or Alternative Cul-de-Sacs
- Reduce Parking Lot Footprints
- Create Landscaping Areas in Parking Lots
- Reduce Driveway Lengths and Widths
- Reduce Sidewalk Lengths and Widths
- Reduce Building Footprints
- Reduce Setbacks and Frontages

The use of these better site design techniques not only helps minimize land disturbance and the creation of new impervious and disturbed pervious cover, but also helps preserve pre-development site hydrology and reduce post-construction stormwater runoff rates, volumes and pollutant loads. These better site design techniques also provide a number of other environmental and economic benefits, including reduced land disturbance and soil erosion, urban heat island mitigation, improved aesthetics and improved human health (US EPA, 2008).

Applying Better Site Design Techniques During the Site Planning & Design Process

After completing the natural resources inventory (Section 6.3.3) and using better site planning techniques to protect primary and secondary conservation areas (Section 6.3.4.1), the site planning and design team should be able to define the buildable area on the development site. In accordance with SP&D Criteria #2 (Section 4.3.2), it is *recommended* that consideration be given to using better site design techniques to minimize land disturbance and limit the creation of new impervious and disturbed pervious cover within this buildable area. Additional information about these better site design techniques, including information about how to use them on a development site, can be found in Section 7.7.

It is important to note that, although all of the better site design techniques listed above are *recommended* for use in coastal Georgia, their use may be restricted by local codes and ordinances. Many communities across the country have found that their own local "development rules" (e.g., subdivision ordinances, zoning ordinances, parking lot and street design standards) have prevented these better site design techniques from being applied during the site planning and design process (CWP, 1998). These communities have found that their own codes and ordinances are responsible for the wide streets, expansive parking lots and large lot subdivisions that are crowding out the very natural resources they are trying to protect.

Obviously, it is difficult to make use of the *recommended* better site design techniques listed above when local "development rules" restrict their use. Although the Center for Watershed Protection (CWP, 1998) has developed a process that Georgia's coastal communities can use to review and revise these "development rules," it often takes some time to work through this process. Therefore, until these revisions have been completed and all of the barriers to the use of better site design techniques have been removed, site planning and design teams are

encouraged to consult with the local development review authority to identify any local restrictions on the use of the better site design techniques discussed in this CSS.

Using Better Site Design Techniques to Help Satisfy the Stormwater Management Criteria

Although the use of better site design techniques can be thought of as a “self-crediting” stormwater management technique (i.e., using them *implicitly* reduces post-construction stormwater runoff rates, volumes and pollutant loads), it is important not to overlook the stormwater management and other environmental benefits that these techniques provide. Consequently, they have been assigned quantifiable stormwater management “credits” that can be used when calculating the stormwater runoff volumes associated with the SWM Criteria presented in this CSS. While Table 6.2 summarizes these “credits,” additional information about them, including information about how they can be used to help satisfy the SWM Criteria presented in this CSS, is provided in Section 7.7.

Table 6.2: How Better Site Design Techniques Can Be Used to Help Satisfy the Stormwater Management Criteria

Better Site Design Technique	Stormwater Runoff Reduction	Water Quality Protection	Aquatic Resource Protection	Overbank Flood Protection	Extreme Flood Protection
Reduce Clearing and Grading Limits	"Credit": Subtract 50% of any <i>undisturbed pervious areas</i> from the total site area when calculating the runoff reduction volume (RR _v) that applies to a development site.	"Credit": Subtract 50% of any <i>undisturbed pervious areas</i> from the total site area when calculating the runoff reduction volume (RR _v) that applies to a development site.	"Credit": Assume that the post-development hydrologic conditions of any <i>undisturbed pervious areas</i> are equivalent to the pre-development hydrologic conditions for those same areas.	"Credit": Assume that the post-development hydrologic conditions of any <i>undisturbed pervious areas</i> are equivalent to the pre-development hydrologic conditions for those same areas.	"Credit": Assume that the post-development hydrologic conditions of any <i>undisturbed pervious areas</i> are equivalent to the pre-development hydrologic conditions for those same areas.
Reduce Roadway Lengths and Widths	"Credit": "Self-crediting," in that minimizing the creation of new impervious cover results in a lower volumetric runoff coefficient (R _v) and, consequently, a lower runoff reduction volume (RR _v) on a development site.	"Credit": "Self-crediting," in that minimizing the creation of new impervious cover results in a lower volumetric runoff coefficient (R _v) and, consequently, a lower runoff reduction volume (RR _v) on a development site.	"Credit": "Self-crediting," in that minimizing the creation of new impervious cover results in a lower runoff curve number (CN) and, consequently, a lower aquatic resource protection volume (ARP _v) on a development site.	"Credit": "Self-crediting," in that minimizing the creation of new impervious cover results in a lower runoff curve number (CN) and, consequently, a lower overbank peak discharge (Q _{p25}) on a development site.	"Credit": "Self-crediting," in that minimizing the creation of new impervious cover results in a lower runoff curve number (CN) and, consequently, a lower extreme peak discharge (Q _{p100}) on a development site.
Use Fewer or Alternative Cul-de-Sacs					
Reduce Parking Lot Footprints					
Create Landscaping Areas in Parking Lots					
Reduce Driveway Lengths and Widths					
Reduce Sidewalk Lengths and Widths					
Reduce Building Footprints					
Reduce Setbacks and Frontages					

6.3.4.3 Step 4.3: Calculate Stormwater Management Criteria

By using a variety of better site planning and design techniques during the creation of a stormwater management concept plan (Figure 6.10), it is possible to significantly reduce post-construction stormwater runoff rates, volumes and pollutant loads on a development site. This helps reduce the size and cost of the low impact development and stormwater management practices that are needed to satisfy the SWM Criteria presented in this CSS, which typically results in significant cost savings for the developer and, when long-term maintenance costs are considered, for the local development review authority as well. Consequently, in accordance with SP&D Criteria #2, it is *recommended* that better site planning and design techniques be used to the *maximum extent practical* during the creation of a stormwater management concept plan.

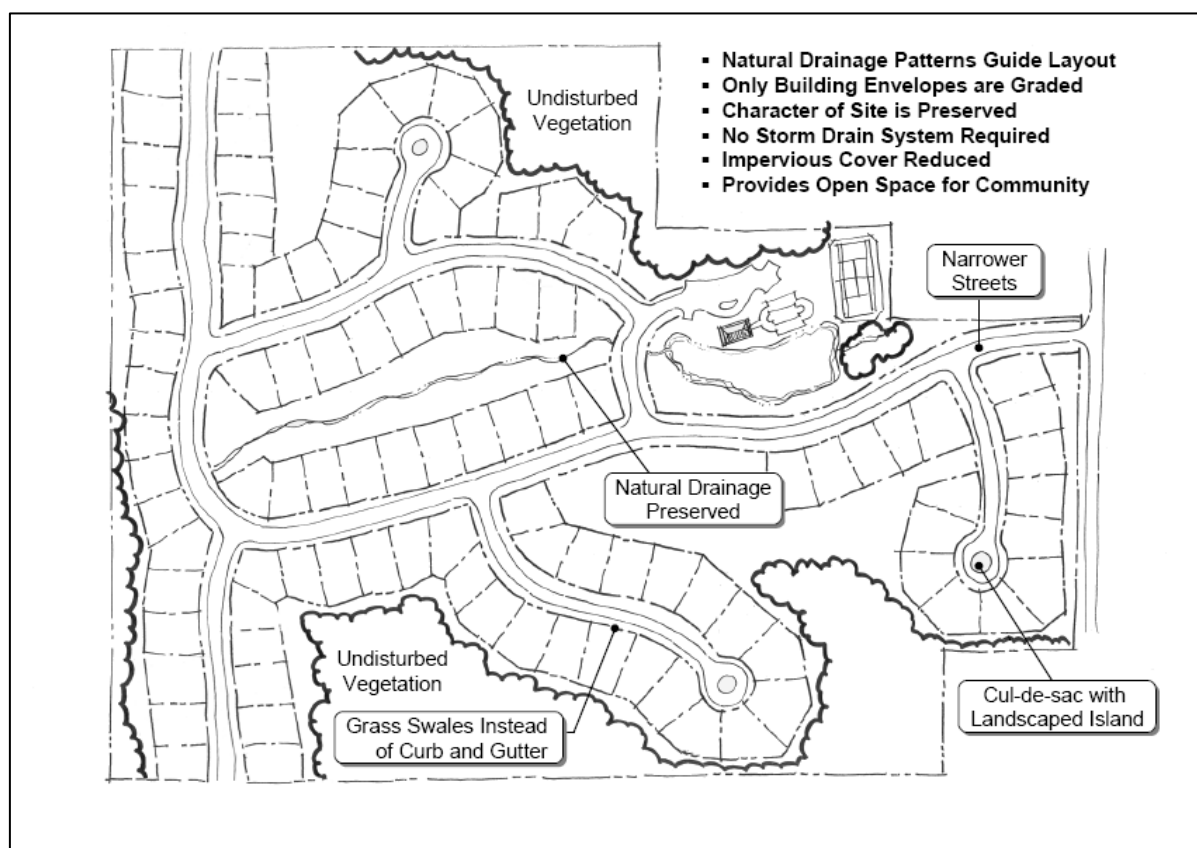

Figure 6.10: Stormwater Management Concept Plan that Incorporates a Variety of Better Site Planning and Design Techniques

(Source: Atlanta Regional Commission, 2001)

Since the use of better site planning and design techniques can significantly reduce post-construction stormwater runoff rates, volumes and pollutant loads, site planning and design teams need not calculate the stormwater runoff volumes associated with the SWM Criteria that apply to a development site until they have completed an initial layout of the proposed development project. This helps provide the site planning and design team with a “blank canvas” during the creation of the development plan, one which is intended to encourage creativity and the use of a variety of better site planning and design techniques during the layout of the proposed development project. Information about calculating the stormwater runoff volumes associated with the SWM Criteria that apply to a development site is provided in

Section 5.0, while information about applying the stormwater management “credits” associated with each of the better site planning and design techniques is provided in Sections 7.6-7.7.

Once an initial estimate of the stormwater runoff volumes associated with the SWM Criteria that apply to a development site has been completed, the site planning and design team may want to go back to the stormwater management concept plan and apply additional better site design and planning techniques to further reduce post-construction stormwater runoff rates, volumes and pollutant loads. During this iterative site design process, several alternative concept plans can be created (Figures 6.2-6.4) and compared with one another to come up with a plan that will best “fit” the character of the site and best meet the stormwater management and site planning and design criteria presented in this CSS.

6.3.4.4 Step 4.4: Apply Low Impact Development Practices

The next step in the process of developing a stormwater management concept plan is to distribute low impact development practices across the development site. These low impact development practices not only help maintain pre-development site hydrology, by reducing post-construction stormwater runoff rates, volumes and pollutant loads, but also provide a number of other important environmental and economic benefits, including reduced energy demand, urban heat island mitigation, improved aesthetics and improved human health (US EPA, 2008).

The low impact development practices *recommended* for use in coastal Georgia have been divided into three groups: (1) alternatives to disturbed pervious surfaces; (2) alternatives to impervious surfaces; and (3) “receiving” low impact development practices. Each of these groups is briefly described below:

Alternatives to Disturbed Pervious Surfaces

These low impact development practices can be used to help restore disturbed pervious surfaces to their pre-development conditions, which helps reduce post-construction stormwater runoff rates, volumes and pollutant loads. They can be used alone or in combination with one another to restore soils and native vegetative cover in areas that have been or will be disturbed by clearing, grading and other land disturbing activities (Figure 6.11). The alternatives to disturbed pervious surfaces *recommended* for use in coastal Georgia include:

- Soil Restoration
- Site Reforestation/Revegetation



Figure 6.11: Reforestation of a Disturbed Pervious Area

(Source: Center for Watershed Protection)

Alternatives to Impervious Surfaces

These low impact development practices can be used to reduce the amount of “effective” impervious cover found on a development site. They can be used in place of traditional impervious surfaces, such as rooftops (Figure 6.12), parking lots and driveways, to reduce the post-construction stormwater runoff rates, volumes and pollutant loads that these surfaces

create. The alternatives to impervious surfaces *recommended* for use in coastal Georgia include:

- Green Roofs
- Permeable Pavement

“Receiving” Low Impact Development Practices

These low impact development practices can be used to “receive” and reduce the post-construction stormwater runoff generated on a development site (Figure 6.13). They are designed to slow and temporarily store stormwater runoff, subjecting it to the runoff reducing hydrologic processes of interception, evapotranspiration, infiltration and capture and reuse, before directing it into the stormwater conveyance system. The low impact development practices that can be used to “receive” post-construction stormwater runoff on a development site include:

- Undisturbed Pervious Areas
- Vegetated Filter Strips
- Grass Channels
- Simple Downspout Disconnection
- Rain Gardens
- Stormwater Planters
- Dry Wells
- Rainwater Harvesting
- Bioretention Areas
- Infiltration Practices
- Dry Swales

Applying Low Impact Development Practices During the Site Planning & Design Process

After an initial layout of the proposed development project has been completed using better site planning and design techniques (Sections 6.3.4.1-6.3.4.2), and an initial estimate of the stormwater runoff volumes associated with the SWM Criteria that apply to a development site has been completed (Section 6.3.4.3), the site planning and design team should be able to begin distributing low impact development practices across the development site. Many of these practices can be placed in the disturbed and undisturbed pervious areas that were protected earlier in the process through the use of better site planning and design techniques.

At this point in the site planning and design process, a site planning and design team should have a pretty good understanding of the post-construction stormwater runoff rates, volumes and pollutant loads that they will need to manage on the development site. In accordance with SP&D Criteria #2 (Section 4.3.2), it is *recommended* that low impact development practices be used, to the *maximum extent practical*, to reduce these post-construction stormwater runoff rates, volumes and pollutant loads on the development site. Additional information about these low impact development practices, including information about their proper application and design, can be found in Section 7.8.



Figure 6.12: Green Roof Used in Place of a Traditional Impervious Rooftop
(Source: Center for Watershed Protection)



Figure 6.13: Rain Garden Used to “Receive” Stormwater Runoff
(Source: Center for Watershed Protection)

When applying low impact development practices to a development site, it is important that they be treated just like stormwater management practices. They should be placed in drainage or maintenance easements and included in all stormwater management system inspection and maintenance plans (SP&D Criteria #6).

Using Low Impact Development Practices to Help Satisfy the Stormwater Management Criteria

The Center for Watershed Protection (Hirschman et al., 2008) recently documented the ability of low impact development and stormwater management practices to reduce annual stormwater runoff volumes and pollutant loads on development sites (Table 6.3). Based on their ability to provide these measurable reductions in annual stormwater runoff volumes and pollutant loads, all of the low impact development practices *recommended* for use in coastal Georgia have been assigned quantifiable stormwater management “credits” that can be used to help satisfy the SWM Criteria presented in this CSS. While Table 6.4 summarizes all of these “credits,” additional information about them, including information about how they can be used to help satisfy the SWM Criteria presented in this CSS, is provided in Section 7.8.

Table 6.3: Ability of Low Impact Development and Stormwater Management Practices to Reduce Annual Stormwater Runoff Volumes and Pollutant Loads

(Source: Hirschman et al., 2008)

Practice	Annual Runoff Volume Reduction (%)	Annual Total Phosphorus (TP) Load Removal (%)	Annual Total Nitrogen (TN) Load Removal (%)
Green Roof	45 to 60	45 to 60	45 to 60
Rooftop Disconnection	25 to 50	25 to 50	25 to 50
Raintanks and Cisterns	40	40	40
Permeable Pavement	45 to 75	59 to 81	59 to 81
Grass Channel	10 to 20	23 to 32	28 to 36
Bioretention	40 to 80	55 to 90	64 to 92
Dry Swale	40 to 60	52 to 76	55 to 74
Wet Swale	0	20 to 40	25 to 35
Infiltration	50 to 90	63 to 93	57 to 92
Dry Extended Detention Pond	0 to 15	15 to 28	10 to 24
Soil Amendments	50 to 75	50 to 75	50 to 75
Sheetflow to Open Space	50 to 75	50 to 75	50 to 75
Filtering Practice	0	60 to 65	30 to 45
Constructed Wetland	0	50 to 75	25 to 55
Wet Pond	0	50 to 75	30 to 40

Table 6.4: How Low Impact Development Practices Can Be Used to Help Satisfy the Stormwater Management Criteria

Low Impact Development Practice	Stormwater Runoff Reduction	Water Quality Protection	Aquatic Resource Protection	Overbank Flood Protection	Extreme Flood Protection
Alternatives to Disturbed Pervious Surfaces					
Soil Restoration	"Credit": Subtract 50% of any <i>restored pervious areas</i> from the total site area and re-calculate the runoff reduction volume (RR _v) that applies to a development site.	"Credit": Subtract 50% of any <i>restored pervious areas</i> from the total site area and re-calculate the runoff reduction volume (RR _v) that applies to a development site.	"Credit": Assume that the post-development hydrologic conditions of any <i>restored pervious areas</i> are equivalent to those of open space in good condition.	"Credit": Assume that the post-development hydrologic conditions of any <i>restored pervious areas</i> are equivalent to those of open space in good condition.	"Credit": Assume that the post-development hydrologic conditions of any <i>restored pervious areas</i> are equivalent to those of open space in good condition.
Site Reforestation/ Revegetation	"Credit": Subtract 50% of any <i>reforested/revegetated areas</i> from the total site area and re-calculate the runoff reduction volume (RR _v) that applies to a development site.	"Credit": Subtract 50% of any <i>reforested/revegetated areas</i> from the total site area and re-calculate the runoff reduction volume (RR _v) that applies to a development site.	"Credit": Assume that the post-development hydrologic conditions of any <i>reforested/revegetated areas</i> are equivalent to those of a similar cover type in fair condition.	"Credit": Assume that the post-development hydrologic conditions of any <i>reforested/revegetated areas</i> are equivalent to those of a similar cover type in fair condition.	"Credit": Assume that the post-development hydrologic conditions of any <i>reforested/revegetated areas</i> are equivalent to those of a similar cover type in fair condition.
Soil Restoration with Site Reforestation/ Revegetation	"Credit": Subtract 100% of any <i>restored and reforested/revegetated areas</i> from the total site area and re-calculate the runoff reduction volume (RR _v) that applies to a development site.	"Credit": Subtract 100% of any <i>restored and reforested/revegetated areas</i> from the total site area and re-calculate the runoff reduction volume (RR _v) that applies to a development site.	"Credit": Assume that the post-development hydrologic conditions of any <i>restored and reforested/revegetated areas</i> are equivalent to those of a similar cover type in good condition.	"Credit": Assume that the post-development hydrologic conditions of any <i>restored and reforested/revegetated areas</i> are equivalent to those of a similar cover type in good condition.	"Credit": Assume that the post-development hydrologic conditions of any <i>restored and reforested/revegetated areas</i> are equivalent to those of a similar cover type in good condition.
Alternatives to Impervious Surfaces					
Green Roofs	"Credit": Reduce the runoff reduction volume (RR _v) conveyed through a <i>green roof</i> by 60%.	"Credit": Reduce the runoff reduction volume (RR _v) conveyed through a <i>green roof</i> by 60%.	"Credit": Proportionally adjust the post-development runoff curve number (CN) to account for the runoff reduction provided by a <i>green roof</i> when calculating the aquatic resource protection volume (ARP _v) on a development site.	"Credit": Proportionally adjust the post-development runoff curve number (CN) to account for the runoff reduction provided by a <i>green roof</i> when calculating the overbank peak discharge (Q _{p25}) on a development site.	"Credit": Proportionally adjust the post-development runoff curve number (CN) to account for the runoff reduction provided by a <i>green roof</i> when calculating the extreme peak discharge (Q _{p100}) on a development site.

Table 6.4: How Low Impact Development Practices Can Be Used to Help Satisfy the Stormwater Management Criteria

Low Impact Development Practice	Stormwater Runoff Reduction	Water Quality Protection	Aquatic Resource Protection	Overbank Flood Protection	Extreme Flood Protection
Permeable Pavement, No Underdrain	<p>“Credit”: Subtract 100% of the storage volume provided by a non-underdrained <i>permeable pavement system</i> from the runoff reduction volume (RR_v) conveyed through the <i>system</i>.</p>	<p>“Credit”: Subtract 100% of the storage volume provided by a non-underdrained <i>permeable pavement system</i> from the runoff reduction volume (RR_v) conveyed through the <i>system</i>.</p>	<p>“Credit”: Proportionally adjust the post-development runoff curve number (CN) to account for the runoff reduction provided by a <i>permeable pavement system</i> when calculating the aquatic resource protection volume (ARP_v) on a development site.</p>	<p>“Credit”: Proportionally adjust the post-development runoff curve number (CN) to account for the runoff reduction provided by a <i>permeable pavement system</i> when calculating the overbank peak discharge (Q_{p25}) on a development site.</p>	<p>“Credit”: Proportionally adjust the post-development runoff curve number (CN) to account for the runoff reduction provided by a <i>permeable pavement system</i> when calculating the extreme peak discharge (Q_{p100}) on a development site.</p>
Permeable Pavement, Underdrain	<p>“Credit”: Subtract 50% of the storage volume provided by an underdrained <i>permeable pavement system</i> from the runoff reduction volume (RR_v) conveyed through the <i>system</i>.</p>	<p>“Credit”: Subtract 50% of the storage volume provided by an underdrained <i>permeable pavement system</i> from the runoff reduction volume (RR_v) conveyed through the <i>system</i>.</p>			
“Receiving” Low Impact Development Practices					
Undisturbed Pervious Areas, A/B Soils	<p>“Credit”: Reduce the runoff reduction volume (RR_v) conveyed through an <i>undisturbed pervious area</i> located on A/B soils by 90%.</p>	<p>“Credit”: Reduce the runoff reduction volume (RR_v) conveyed through an <i>undisturbed pervious area</i> located on A/B soils by 90%.</p>	<p>“Credit”: Proportionally adjust the post-development runoff curve number (CN) to account for the runoff reduction provided by an <i>undisturbed pervious area</i> when calculating the aquatic resource protection volume (ARP_v) on a development site.</p>	<p>“Credit”: Proportionally adjust the post-development runoff curve number (CN) to account for the runoff reduction provided by an <i>undisturbed pervious area</i> when calculating the overbank peak discharge (Q_{p25}) on a development site.</p>	<p>“Credit”: Proportionally adjust the post-development runoff curve number (CN) to account for the runoff reduction provided by an <i>undisturbed pervious area</i> when calculating the extreme peak discharge (Q_{p100}) on a development site.</p>
Undisturbed Pervious Areas, C/D Soils	<p>“Credit”: Reduce the runoff reduction volume (RR_v) conveyed through an <i>undisturbed pervious area</i> located on C/D soils by 60%.</p>	<p>“Credit”: Reduce the runoff reduction volume (RR_v) conveyed through an <i>undisturbed pervious area</i> located on C/D soils by 60%.</p>			

Table 6.4: How Low Impact Development Practices Can Be Used to Help Satisfy the Stormwater Management Criteria

Low Impact Development Practice	Stormwater Runoff Reduction	Water Quality Protection	Aquatic Resource Protection	Overbank Flood Protection	Extreme Flood Protection
Vegetated Filter Strips, A/B or Amended Soils	"Credit": Reduce the runoff reduction volume (RR _v) conveyed through a <i>vegetated filter strip</i> located on A/B or amended soils by 60%.	"Credit": Reduce the runoff reduction volume (RR _v) conveyed through a <i>vegetated filter strip</i> located on A/B or amended soils by 60%.	"Credit": Proportionally adjust the post-development runoff curve number (CN) to account for the runoff reduction provided by a <i>vegetated filter strip</i> when calculating the aquatic resource protection volume (ARP _v) on a development site.	"Credit": Proportionally adjust the post-development runoff curve number (CN) to account for the runoff reduction provided by a <i>vegetated filter strip</i> when calculating the overbank peak discharge (Q _{p25}) on a development site.	"Credit": Proportionally adjust the post-development runoff curve number (CN) to account for the runoff reduction provided by a <i>vegetated filter strip</i> when calculating the extreme peak discharge (Q _{p100}) on a development site.
Vegetated Filter Strips, C/D Soils	"Credit": Reduce the runoff reduction volume (RR _v) conveyed through a <i>vegetated filter strip</i> located on C/D soils by 30%.	"Credit": Reduce the runoff reduction volume (RR _v) conveyed through a <i>vegetated filter strip</i> located on C/D soils by 30%.			
Grass Channels, A/B or Amended Soils	"Credit": Reduce the runoff reduction volume (RR _v) conveyed through a <i>grass channel</i> located on A/B or amended soils by 25%.	"Credit": Reduce the runoff reduction volume (RR _v) conveyed through a <i>grass channel</i> located on A/B or amended soils by 25%.	"Credit": Proportionally adjust the post-development runoff curve number (CN) to account for the runoff reduction provided by a <i>vegetated filter strip</i> when calculating the aquatic resource protection volume (ARP _v) on a development site.	"Credit": Proportionally adjust the post-development runoff curve number (CN) to account for the runoff reduction provided by a <i>vegetated filter strip</i> when calculating the overbank peak discharge (Q _{p25}) on a development site.	"Credit": Proportionally adjust the post-development runoff curve number (CN) to account for the runoff reduction provided by a <i>vegetated filter strip</i> when calculating the extreme peak discharge (Q _{p100}) on a development site.
Grass Channels, C/D Soils	"Credit": Reduce the runoff reduction volume (RR _v) conveyed through a <i>grass channel</i> located on C/D soils by 12.5%.	"Credit": Reduce the runoff reduction volume (RR _v) conveyed through a <i>grass channel</i> located on C/D soils by 12.5%.			
Simple Downspout Disconnection, A/B or Amended Soils	"Credit": Reduce the runoff reduction volume (RR _v) conveyed through a <i>simple downspout disconnection</i> located on A/B or amended soils by 60%.	"Credit": Reduce the runoff reduction volume (RR _v) conveyed through a <i>simple downspout disconnection</i> located on A/B or amended soils by 60%.	"Credit": Proportionally adjust the post-development runoff curve number (CN) to account for the runoff reduction provided by a <i>simple downspout disconnection</i> when calculating the aquatic resource protection volume (ARP _v) on a development site.	"Credit": Proportionally adjust the post-development runoff curve number (CN) to account for the runoff reduction provided by a <i>simple downspout disconnection</i> when calculating the overbank peak discharge (Q _{p25}) on a development site.	"Credit": Proportionally adjust the post-development runoff curve number (CN) to account for the runoff reduction provided by a <i>simple downspout disconnection</i> when calculating the extreme peak discharge (Q _{p100}) on a development site.
Simple Downspout Disconnection, C/D Soils	"Credit": Reduce the runoff reduction volume (RR _v) conveyed through a <i>simple downspout disconnection</i> located on C/D soils by 30%.	"Credit": Reduce the runoff reduction volume (RR _v) conveyed through a <i>simple downspout disconnection</i> located on C/D soils by 30%.			

Table 6.4: How Low Impact Development Practices Can Be Used to Help Satisfy the Stormwater Management Criteria

Low Impact Development Practice	Stormwater Runoff Reduction	Water Quality Protection	Aquatic Resource Protection	Overbank Flood Protection	Extreme Flood Protection
Rain Gardens	"Credit": Subtract 100% of the storage volume provided by a <i>rain garden</i> from the runoff reduction volume (RR _v) conveyed through the <i>rain garden</i> .	"Credit": Subtract 100% of the storage volume provided by a <i>rain garden</i> from the runoff reduction volume (RR _v) conveyed through the <i>rain garden</i> .	"Credit": Proportionally adjust the post-development runoff curve number (CN) to account for the runoff reduction provided by a <i>rain garden</i> when calculating the aquatic resource protection volume (ARP _v) on a development site.	"Credit": Proportionally adjust the post-development runoff curve number (CN) to account for the runoff reduction provided by a <i>rain garden</i> when calculating the overbank peak discharge (Q _{p25}) on a development site.	"Credit": Proportionally adjust the post-development runoff curve number (CN) to account for the runoff reduction provided by a <i>rain garden</i> when calculating the extreme peak discharge (Q _{p100}) on a development site.
Stormwater Planters	"Credit": Subtract 50% of the storage volume provided by a <i>stormwater planter</i> from the runoff reduction volume (RR _v) conveyed through the <i>stormwater planter</i> .	"Credit": Subtract 50% of the storage volume provided by a <i>stormwater planter</i> from the runoff reduction volume (RR _v) conveyed through the <i>stormwater planter</i> .	"Credit": Proportionally adjust the post-development runoff curve number (CN) to account for the runoff reduction provided by a <i>stormwater planter</i> when calculating the aquatic resource protection volume (ARP _v) on a development site.	"Credit": Proportionally adjust the post-development runoff curve number (CN) to account for the runoff reduction provided by a <i>stormwater planter</i> when calculating the overbank peak discharge (Q _{p25}) on a development site.	"Credit": Proportionally adjust the post-development runoff curve number (CN) to account for the runoff reduction provided by a <i>stormwater planter</i> when calculating the extreme peak discharge (Q _{p100}) on a development site.
Dry Wells	"Credit": Subtract 100% of the storage volume provided by a <i>dry well</i> from the runoff reduction volume (RR _v) conveyed through the <i>dry well</i> .	"Credit": Subtract 100% of the storage volume provided by a <i>dry well</i> from the runoff reduction volume (RR _v) conveyed through the <i>dry well</i> .	"Credit": Proportionally adjust the post-development runoff curve number (CN) to account for the runoff reduction provided by a <i>dry well</i> when calculating the aquatic resource protection volume (ARP _v) on a development site.	"Credit": Proportionally adjust the post-development runoff curve number (CN) to account for the runoff reduction provided by a <i>dry well</i> when calculating the overbank peak discharge (Q _{p25}) on a development site.	"Credit": Proportionally adjust the post-development runoff curve number (CN) to account for the runoff reduction provided by a <i>dry well</i> when calculating the extreme peak discharge (Q _{p100}) on a development site.
Rainwater Harvesting	"Credit": Subtract 75% of the storage volume provided by a <i>rainwater harvesting system</i> from the runoff reduction volume (RR _v) captured by the <i>system</i> .	"Credit": Subtract 75% of the storage volume provided by a <i>rainwater harvesting system</i> from the runoff reduction volume (RR _v) captured by the <i>system</i> .	"Credit": Proportionally adjust the post-development runoff curve number (CN) to account for the runoff reduction provided by a <i>rainwater harvesting system</i> when calculating the aquatic resource protection volume (ARP _v) on a development site.	"Credit": Proportionally adjust the post-development runoff curve number (CN) to account for the runoff reduction provided by a <i>rainwater harvesting system</i> when calculating the overbank peak discharge (Q _{p25}) on a development site.	"Credit": Proportionally adjust the post-development runoff curve number (CN) to account for the runoff reduction provided by a <i>rainwater harvesting system</i> when calculating the extreme peak discharge (Q _{p100}) on a development site.

Table 6.4: How Low Impact Development Practices Can Be Used to Help Satisfy the Stormwater Management Criteria

Low Impact Development Practice	Stormwater Runoff Reduction	Water Quality Protection	Aquatic Resource Protection	Overbank Flood Protection	Extreme Flood Protection
Bioretention Areas, No Underdrain	"Credit": Subtract 100% of the storage volume provided by a non-underdrained <i>bioretention area</i> from the runoff reduction volume (RR _v) conveyed through the <i>bioretention area</i> .	"Credit": Subtract 100% of the storage volume provided by a non-underdrained <i>bioretention area</i> from the runoff reduction volume (RR _v) conveyed through the <i>bioretention area</i> .	"Credit": Proportionally adjust the post-development runoff curve number (CN) to account for the runoff reduction provided by a <i>bioretention area</i> when calculating the aquatic resource protection volume (ARP _v) on a development site.	"Credit": Proportionally adjust the post-development runoff curve number (CN) to account for the runoff reduction provided by a <i>bioretention area</i> when calculating the overbank peak discharge (Q _{p25}) on a development site.	"Credit": Proportionally adjust the post-development runoff curve number (CN) to account for the runoff reduction provided by a <i>bioretention area</i> when calculating the extreme peak discharge (Q _{p100}) on a development site.
Bioretention Areas, Underdrain	"Credit": Subtract 50% of the storage volume provided by an underdrained <i>bioretention area</i> from the runoff reduction volume (RR _v) conveyed through the <i>bioretention area</i> .	"Credit": Subtract 50% of the storage volume provided by an underdrained <i>bioretention area</i> from the runoff reduction volume (RR _v) conveyed through the <i>bioretention area</i> .			
Infiltration Practices	"Credit": Subtract 100% of the storage volume provided by an <i>infiltration practice</i> from the runoff reduction volume (RR _v) conveyed through the <i>infiltration practice</i> .	"Credit": Subtract 100% of the storage volume provided by an <i>infiltration practice</i> from the runoff reduction volume (RR _v) conveyed through the <i>infiltration practice</i> .	"Credit": Proportionally adjust the post-development runoff curve number (CN) to account for the runoff reduction provided by an <i>infiltration practice</i> when calculating the aquatic resource protection volume (ARP _v) on a development site.	"Credit": Proportionally adjust the post-development runoff curve number (CN) to account for the runoff reduction provided by an <i>infiltration practice</i> when calculating the overbank peak discharge (Q _{p25}) on a development site.	"Credit": Proportionally adjust the post-development runoff curve number (CN) to account for the runoff reduction provided by an <i>infiltration practice</i> when calculating the extreme peak discharge (Q _{p100}) on a development site.
Dry Swales, No Underdrain	"Credit": Subtract 100% of the storage volume provided by a non-underdrained <i>dry swale</i> from the runoff reduction volume (RR _v) conveyed through the <i>dry swale</i> .	"Credit": Subtract 100% of the storage volume provided by a non-underdrained <i>dry swale</i> from the runoff reduction volume (RR _v) conveyed through the <i>dry swale</i> .	"Credit": Proportionally adjust the post-development runoff curve number (CN) to account for the runoff reduction provided by a <i>dry swale</i> when calculating the aquatic resource protection volume (ARP _v) on a development site.	"Credit": Proportionally adjust the post-development runoff curve number (CN) to account for the runoff reduction provided by a <i>dry swale</i> when calculating the overbank peak discharge (Q _{p25}) on a development site.	"Credit": Proportionally adjust the post-development runoff curve number (CN) to account for the runoff reduction provided by a <i>dry swale</i> when calculating the extreme peak discharge (Q _{p100}) on a development site.
Dry Swales, Underdrain	"Credit": Subtract 50% of the storage volume provided by an underdrained <i>dry swale</i> from the runoff reduction volume (RR _v) conveyed through the <i>dry swale</i> .	"Credit": Subtract 50% of the storage volume provided by an underdrained <i>dry swale</i> from the runoff reduction volume (RR _v) conveyed through the <i>dry swale</i> .			

6.3.4.5 Step 4.5: Check to See If Stormwater Management Criteria Have Been Met

By distributing runoff reducing low impact development practices across a development site (Figure 6.14), and applying the associated stormwater management “credits,” it is possible to significantly reduce post-construction stormwater runoff rates, volumes and pollutant loads. Therefore, at this point in the process of developing a stormwater management concept plan, it is *recommended* that site planning and design teams check to see if the SWM Criteria that apply to the development site have been met.

Depending on the number and type of low impact development practices that have been used, the post-construction stormwater runoff rates, volumes and pollutant loads generated on the development site may have been significantly reduced. If so, the need for larger and more costly stormwater management practices, such as wet ponds and stormwater wetlands, may have been significantly reduced or may have been eliminated altogether. Consequently, site planning and design teams are encouraged to experiment with different combinations of low impact development practices on a development site. They are also encouraged to use low impact development practices in series (e.g., simple downspout disconnection to a dry swale to a bioretention area) to maximize the stormwater management and other environmental benefits that these small-scale stormwater management practices provide.

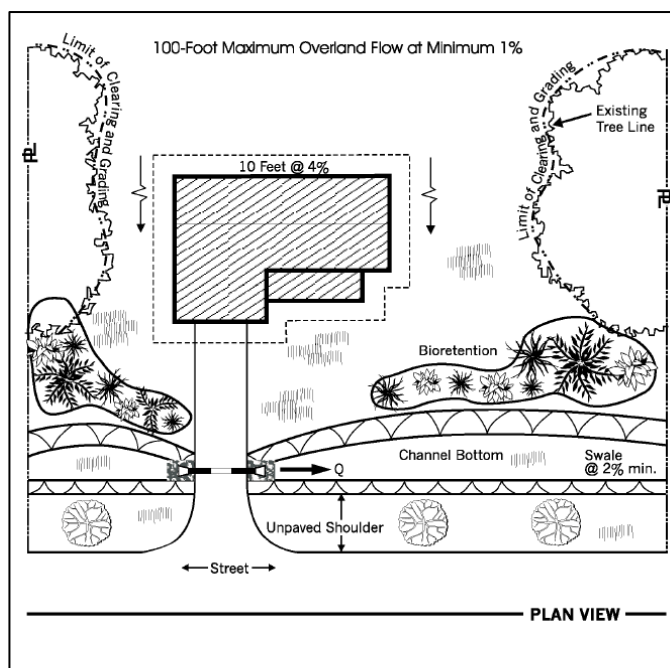

Figure 6.14: Stormwater Management Concept Plan that Incorporates a Variety of Low Impact Development Practices

(Source: Prince George's County, MD, 1999)

If, after checking to see if the SWM Criteria have been met, a site planning and design team finds that they have not, they may want to go back to the stormwater management concept plan to apply additional low impact development practices to further reduce post-construction stormwater runoff rates, volumes and pollutant loads on the development site. In accordance with SWM Criteria #1, if low impact development practices, in combination with the previously applied better site planning and design techniques, cannot, on their own, be used to completely satisfy the stormwater runoff reduction criteria (SWM Criteria #1), or any of the other SWM Criteria, stormwater management practices will need to be used on the development site (Section 6.3.4.6).

6.3.4.6 Step 4.6: Apply Stormwater Management Practices

Once it has been determined that the SWM Criteria presented in this CSS cannot be satisfied exclusively through the use of green infrastructure practices, the next step in the process of developing a stormwater management concept plan is to use stormwater management practices to further *manage* stormwater runoff rates, volumes and pollutant loads on the development site.

Stormwater management practices (also known as *structural stormwater controls*, *structural stormwater best management practices* or *structural stormwater BMPs*) are engineered facilities designed to *intercept and manage* post-construction stormwater runoff rates, volumes and pollutant loads. The stormwater management practices *recommended* for use in coastal Georgia have been divided into two groups: (1) general application practices (also known as *general application controls*); and (2) limited application practices (also known as *limited application controls* or *detention controls*). Each of these groups is briefly described below:

General Application Practices

General application practices can be used to *treat* stormwater runoff and *manage* the post-construction stormwater runoff rates and volumes generated by larger, less frequent rainfall events (e.g., 1-year, 24-hour event, 25-year, 24-hour event). Several of these practices, namely bioretention areas, infiltration practices and dry swales, can also be used to reduce post-construction stormwater runoff volumes and, consequently, are also classified as runoff reducing low impact development practices (Section 6.3.4.4).

Since they can be used to both *treat* and *manage* post-construction stormwater runoff, it is *recommended* that general application practices be used whenever green infrastructure practices cannot, on their own, be used to completely satisfy the stormwater runoff reduction (SWM Criteria #1), stormwater quality protection (SWM Criteria #2), aquatic resource protection (SWM Criteria #3), overbank flood protection (SWM Criteria #4) and extreme flood protection (SWM Criteria #5) criteria presented in this CSS. The general application practices *recommended* for use in coastal Georgia include:

Stormwater Ponds

Stormwater ponds (Figure 6.15) are stormwater detention basins that have a permanent pool of water. Post-construction stormwater runoff is conveyed into the pool, where it is both detained and treated over an extended period of time. The types of stormwater ponds that are *recommended* for use in coastal Georgia include:

- Wet Ponds
- Wet Extended Detention Ponds
- Micropool Extended Detention Ponds
- Multiple Pond Systems

Stormwater Wetlands

Stormwater wetlands (Figure 6.16) are constructed wetland systems built for stormwater management purposes. Stormwater wetlands typically consist of a combination of open water, shallow marsh and semi-wet areas, and can be used to both detain and treat post-construction stormwater runoff. The types of stormwater wetlands that are *recommended* for use in



Figure 6.15: Stormwater Pond
(Source: Atlanta Regional Commission, 2001)



Figure 6.16: Stormwater Wetland
(Source: Merrill et al., 2006)

coastal Georgia include:

- Shallow Wetlands
- Extended Detention Shallow Wetlands
- Pond/Wetland Systems
- Pocket Wetlands

Bioretention Areas

Bioretention areas (Figure 6.17), which may also be classified as a low impact development practice (Section 6.3.4.4), are shallow depressional areas that use an engineered soil mix and vegetation to intercept and treat post-construction stormwater runoff. After passing through a bioretention area, stormwater runoff may be returned to the stormwater conveyance system through an underdrain, or may be allowed to fully or partially infiltrate into the surrounding soils.



Figure 6.17: Bioretention Area
(Source: Center for Watershed Protection)

Filtration Practices

Filtration practices are multi-chamber structures designed to treat post-construction stormwater runoff using the physical processes of screening and filtration. Sand is typically used as the filter media. After passing through a filtration practice, stormwater runoff is typically returned to the conveyance system through an underdrain. The filtration practices that are *recommended* for use in coastal Georgia include:

- Surface Sand Filter
- Perimeter Sand Filter

Infiltration Practices

Infiltration practices (Figure 6.18), which may also be classified as a low impact development practice (Section 6.3.4.4), are shallow excavations, typically filled with stone or an engineered soil mix, that are designed to intercept and temporarily store post-construction stormwater runoff until it infiltrates into the surrounding soils. The infiltration practices that are *recommended* for use in coastal Georgia include:

- Infiltration Trench
- Infiltration Basin



Figure 6.18: Infiltration Trench
(Source: Center for Watershed Protection)

Swales

Swales (Figure 6.19) are vegetated open channels that are designed to manage post-construction stormwater runoff within a series of linear wet or dry cells formed by check dams or

other control structures (e.g., culverts). The two types of swales that are *recommended* for use in coastal Georgia include:

- Dry Swale
- Wet Swale

Because of their ability to reduce annual stormwater runoff volumes and pollutant loads, dry swales may also be classified as a low impact development practice (Section 6.3.4.4).

Limited Application Practices

There are two groups of limited application stormwater management practices that can be used in coastal Georgia, each of which is briefly described below:

Water Quantity Management Practices

Water quantity management practices (Figure 6.20) can only be used to *manage* the post-construction stormwater runoff rates and volumes generated by larger, less frequent rainfall events (e.g., 1-year, 24-hour event, 25-year, 24-hour event). They provide little, if any, stormwater runoff reduction or stormwater treatment. Consequently, it is *recommended* that they be used only on a limited basis, and only when green infrastructure practices and general application stormwater management practices cannot be used to completely satisfy the aquatic resource protection (SWM Criteria #3), overbank flood protection (SWM Criteria #4) and extreme flood protection (SWM Criteria #5) criteria presented in this CSS. The water quantity management practices that may be used in coastal Georgia include:

- Dry Detention Basins
- Dry Extended Detention Basins
- Multi-Purpose Detention Areas
- Underground Detention Systems

Water Quality Management Practices

Water quality management practices can only be used to *treat* post-construction stormwater runoff. They typically have high or special maintenance requirements, provide little, if any, stormwater runoff reduction and cannot be used to *manage* the post-construction stormwater runoff rates and volumes generated by larger, less frequent rainfall events (e.g., 1-year, 24-hour event, 25-year, 24-hour event). Consequently, it is *recommended* that they be used only on a limited basis, and only when green infrastructure practices and general application stormwater management practices cannot be used to completely satisfy the stormwater runoff reduction



Figure 6.19: Wet Swale

(Source: Center for Watershed Protection)



Figure 6.20: Dry Detention Basin Used to Provide Water Quantity Management

(Source: Center for Watershed Protection)

(SWM Criteria #1) and stormwater quality protection criteria (SWM Criteria #2) presented in this CSS. The water quality management practices that may be used in coastal Georgia include:

- Organic Filters
- Underground Filters
- Submerged Gravel Wetlands
- Gravity (Oil-Grit) Separators
- Alum Treatment Systems
- Proprietary Systems

Applying Stormwater Management Practices During the Site Planning & Design Process

After low impact development practices have been distributed across the development site, and it has been determined that the SWM Criteria that apply to the development site cannot be satisfied exclusively through the use of green infrastructure practices, a site planning and design team should be able to begin applying stormwater management practices to the site to further *manage* post-construction stormwater runoff rates, volumes and pollutant loads. Stormwater management practices should be placed downstream of any previously applied green infrastructure practices to form what are known as “stormwater management trains” (Figure 6.21).

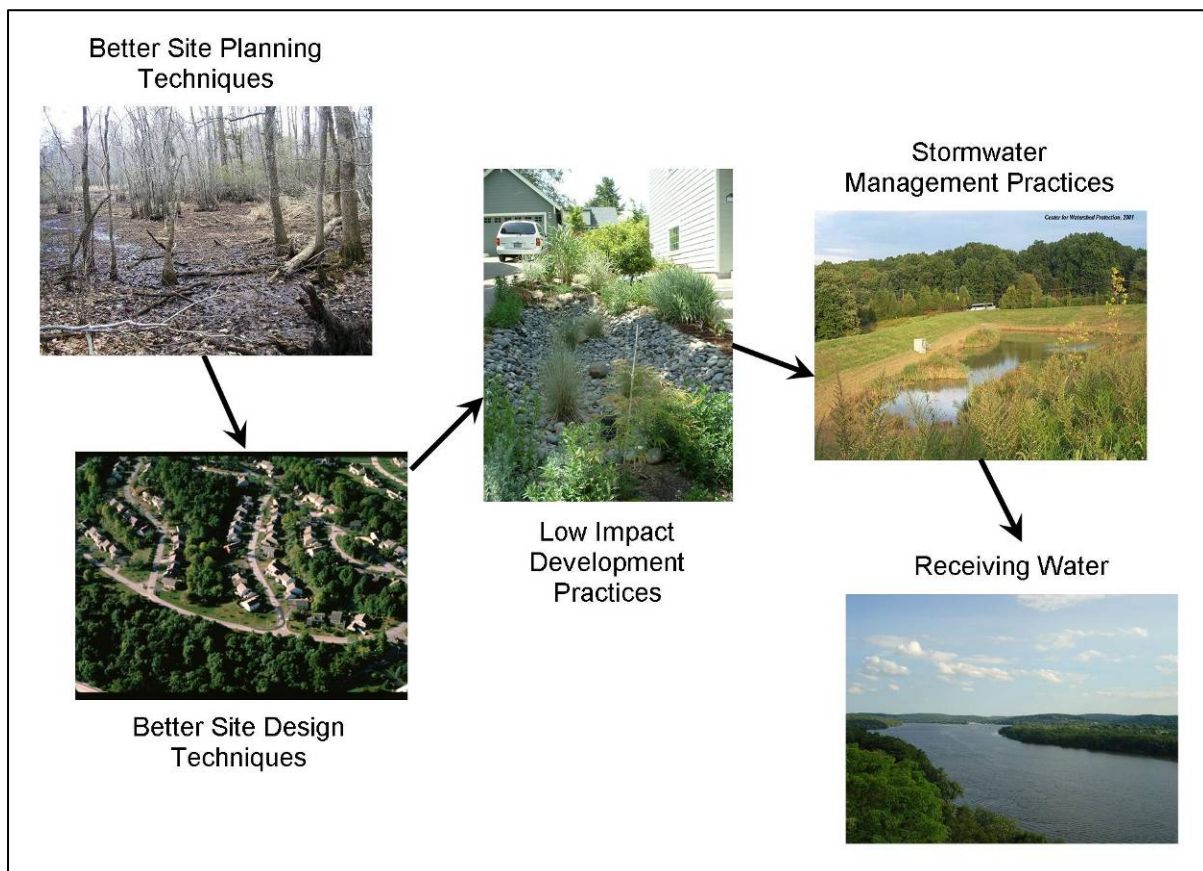

Figure 6.21: Stormwater Management Train

(Source: Center for Watershed Protection)

It is important to note that the structure of the “stormwater management train” illustrated in Figure 6.21 mirrors the step-wise process of developing a stormwater management concept plan for a development site. The position of stormwater management practices within the “stormwater management train” reflects the notion that they should not be used on a development site until it has been determined that the SWM Criteria presented in this CSS cannot be satisfied exclusively through the use of green infrastructure practices.

When applying stormwater management practices to a development site, they should be placed in drainage or maintenance easements and included in all stormwater management system inspection and maintenance plans (SP&D Criteria #6). Additional information about the use of stormwater management practices, including information about their proper application and design, can be found in Section 8.6.

Using Stormwater Management Practices to Help Satisfy the Stormwater Management Criteria

All of the stormwater management practices *recommended* for use in coastal Georgia have been assigned quantifiable stormwater management “credits” corresponding to the stormwater management benefits that they provide. These “credits” can be used to help satisfy the SWM Criteria presented in this CSS. While Table 6.4 summarizes all of these “credits,” additional information about them, including information about how they can be used to help satisfy the SWM Criteria presented in this CSS, is provided in Sections 8.6-8.7.

Table 6.5: How Stormwater Management Practices Can Be Used to Help Satisfy the Stormwater Management Criteria

Stormwater Management Practice	Stormwater Runoff Reduction	Water Quality Protection	Aquatic Resource Protection	Overbank Flood Protection	Extreme Flood Protection
General Application Practices					
Stormwater Ponds	"Credit": None	"Credit": Assume that a <i>stormwater pond</i> provides an 80% reduction in TSS loads ¹ , a 30% reduction in TN loads ² and a 70% reduction in bacteria loads ¹ .	"Credit": A <i>stormwater pond</i> can be designed to provide 24-hours of extended detention for the aquatic resource protection volume (ARP _v).	"Credit": A <i>stormwater pond</i> can be designed to attenuate the overbank peak discharge (Q _{p25}) on a development site.	"Credit": A <i>stormwater pond</i> can be designed to attenuate the extreme peak discharge (Q _{p100}) on a development site.
Stormwater Wetlands	"Credit": None	"Credit": Assume that a <i>stormwater wetland</i> provides an 80% reduction in TSS loads ¹ , a 30% reduction in TN loads ² and an 80% reduction in bacteria loads ¹ .	"Credit": A <i>stormwater wetland</i> can be designed to provide 24-hours of extended detention for the aquatic resource protection volume (ARP _v).	"Credit": A <i>stormwater wetland</i> can be designed to attenuate the overbank peak discharge (Q _{p25}) on a development site.	"Credit": A <i>stormwater wetland</i> can be designed to attenuate the extreme peak discharge (Q _{p100}) on a development site.
Bioretention Areas, No Underdrain	"Credit": Subtract 100% of the storage volume provided by a non-underdrained <i>bioretention area</i> from the runoff reduction volume (RR _v) conveyed through the <i>bioretention area</i> .	"Credit": Assume that a <i>bioretention area</i> provides an 80% reduction in TSS loads ¹ , a 60% reduction in TN loads ² and an 80% reduction in bacteria loads [#] .	"Credit": Although uncommon, on some development sites, a <i>bioretention area</i> can be designed to provide 24-hours of extended detention for the aquatic resource protection volume (ARP _v).	"Credit": Although relatively rare, on some development sites, a <i>bioretention area</i> can be designed to attenuate the overbank peak discharge (Q _{p25}).	"Credit": Although relatively rare, on some development sites, a <i>bioretention area</i> can be designed to attenuate the extreme peak discharge (Q _{p100}).
Bioretention Areas, Underdrain	"Credit": Subtract 50% of the storage volume provided by an underdrained <i>bioretention area</i> from the runoff reduction volume (RR _v) conveyed through the <i>bioretention area</i> .				

Table 6.5: How Stormwater Management Practices Can Be Used to Help Satisfy the Stormwater Management Criteria

Stormwater Management Practice	Stormwater Runoff Reduction	Water Quality Protection	Aquatic Resource Protection	Overbank Flood Protection	Extreme Flood Protection
Filtration Practices	"Credit": None	"Credit": Assume that a <i>filtration practice</i> provides an 80% reduction in TSS loads ¹ , a 30% reduction in TN loads ² and a 40% reduction in bacteria loads ¹ .	"Credit": Although uncommon, on some development sites, a <i>filtration practice</i> can be designed to provide 24-hours of extended detention for the aquatic resource protection volume (ARP _v).	"Credit": Although relatively rare, on some development sites, a <i>filtration practice</i> can be designed to attenuate the overbank peak discharge (Q _{p25}).	"Credit": Although relatively rare, on some development sites, a <i>filtration practice</i> can be designed to attenuate the extreme peak discharge (Q _{p100}).
Infiltration Practices	"Credit": Subtract 100% of the storage volume provided by an <i>infiltration practice</i> from the runoff reduction volume (RR _v) conveyed through the <i>infiltration practice</i> .	"Credit": Assume that an <i>infiltration practice</i> provides an 80% reduction in TSS loads ¹ , an 60% reduction in TN loads ² and an 80% reduction in bacteria loads [#] .	"Credit": Although uncommon, on some development sites, an <i>infiltration practice</i> can be designed to provide 24-hours of extended detention for the aquatic resource protection volume (ARP _v).	"Credit": Although relatively rare, on some development sites, an <i>infiltration practice</i> can be designed to attenuate the overbank peak discharge (Q _{p25}).	"Credit": Although relatively rare, on some development sites, an <i>infiltration practice</i> can be designed to attenuate the extreme peak discharge (Q _{p100}).
Dry Swales, No Underdrain	"Credit": Subtract 100% of the storage volume provided by a non-underdrained <i>dry swale</i> from the runoff reduction volume (RR _v) conveyed through the <i>dry swale</i> .	"Credit": Assume that a <i>dry swale</i> provides an 80% reduction in TSS loads ¹ , a 50% reduction in TN loads ² and a 60% reduction in bacteria loads [#] .	"Credit": Although uncommon, on some development sites, a <i>dry swale</i> can be designed to provide 24-hours of extended detention for the aquatic resource protection volume (ARP _v).	"Credit": Although relatively rare, on some development sites, a <i>dry swale</i> can be designed to attenuate the overbank peak discharge (Q _{p25}).	"Credit": Although relatively rare, on some development sites, a <i>dry swale</i> can be designed to attenuate the extreme peak discharge (Q _{p100}).
Dry Swales, Underdrain	"Credit": Subtract 50% of the storage volume provided by an underdrained <i>dry swale</i> from the runoff reduction volume (RR _v) conveyed through the <i>dry swale</i> .				
Wet Swales	"Credit": None	"Credit": Assume that a <i>wet swale</i> provides an 80% reduction in TSS loads ¹ , a 25% reduction in TN loads ² and a 40% reduction in bacteria loads [#] .	"Credit": Although uncommon, on some development sites, a <i>wet swale</i> can be designed to provide 24-hours of extended detention for the aquatic resource protection volume (ARP _v).	"Credit": Although uncommon, on some development sites, a <i>wet swale</i> can be designed to attenuate the overbank peak discharge (Q _{p25}).	"Credit": Although uncommon, on some development sites, a <i>wet swale</i> can be designed to attenuate the extreme peak discharge (Q _{p100}).

Table 6.5: How Stormwater Management Practices Can Be Used to Help Satisfy the Stormwater Management Criteria

Stormwater Management Practice	Stormwater Runoff Reduction	Water Quality Protection	Aquatic Resource Protection	Overbank Flood Protection	Extreme Flood Protection
Limited Application Practices					
Water Quantity Management Practices					
Dry Detention Basins	"Credit": None	"Credit": None	"Credit": None	"Credit": A <i>dry detention basin</i> can be used to attenuate the overbank peak discharge (Q_{p25}) on a development site.	"Credit": A <i>dry detention basin</i> can be used to attenuate the extreme peak discharge (Q_{p100}) on a development site.
Dry Extended Detention Basins	"Credit": None	"Credit": Assume that a <i>dry extended detention basin</i> provides a 40% reduction in TSS loads ¹ , a 10% reduction in TN loads ² and a 20% reduction in bacteria loads [#] .	"Credit": A <i>dry extended detention basin</i> can be used to provide 24-hours of extended detention for the aquatic resource protection volume (ARP _v).	"Credit": A <i>dry extended detention basin</i> can be used to attenuate the overbank peak discharge (Q_{p25}) on a development site.	"Credit": A <i>dry extended detention basin</i> can be used to attenuate the extreme peak discharge (Q_{p100}) on a development site.
Multi-Purpose Detention Areas	"Credit": None	"Credit": None	"Credit": None	"Credit": A <i>multi-purpose detention area</i> can be used to attenuate the overbank peak discharge (Q_{p25}) on a development site.	"Credit": A <i>multi-purpose detention area</i> can be used to attenuate the overbank peak discharge (Q_{p25}) on a development site.
Underground Detention Systems	"Credit": None	"Credit": None	"Credit": An <i>underground detention system</i> can be used to provide 24-hours of extended detention for the aquatic resource protection volume (ARP _v).	"Credit": An <i>underground detention system</i> can be used to attenuate the overbank peak discharge (Q_{p25}) on a development site.	"Credit": An <i>underground detention system</i> can be used to attenuate the extreme peak discharge (Q_{p100}) on a development site.
Water Quality Management Practices					
Organic Filters	"Credit": None	"Credit": Assume that an <i>organic filter</i> provides an 80% reduction in TSS loads ³ , a 40% reduction in TN loads ³ and a 40% reduction in bacteria loads ¹ .	"Credit": None	"Credit": None	"Credit": None

Table 6.5: How Stormwater Management Practices Can Be Used to Help Satisfy the Stormwater Management Criteria

Stormwater Management Practice	Stormwater Runoff Reduction	Water Quality Protection	Aquatic Resource Protection	Overbank Flood Protection	Extreme Flood Protection
Underground Filters	"Credit": None	"Credit": Assume that an <i>underground filter</i> provides an 80% reduction in TSS loads ¹ , a 30% reduction in TN loads ¹ and a 40% reduction in bacteria loads ¹ .	"Credit": None	"Credit": None	"Credit": None
Submerged Gravel Wetlands	"Credit": None	"Credit": Assume that a <i>submerged gravel wetland</i> provides an 80% reduction in TSS loads ³ , a 20% reduction in TN loads ³ and a 40% reduction in bacteria loads [#] .	"Credit": None	"Credit": None	"Credit": None
Gravity (Oil-Grit) Separators	"Credit": None	"Credit": Assume that a <i>gravity (oil-grit) separator</i> provides a 40% reduction in TSS loads [#] , a 10% reduction in TN loads [#] and a 20% reduction in bacteria loads [#] .	"Credit": None	"Credit": None	"Credit": None
Alum Treatment Systems	"Credit": None	"Credit": Assume that an <i>alum treatment system</i> provides a 90% reduction in TSS loads ⁴ , a 60% reduction in TN loads ⁴ and a 90% reduction in bacteria loads ⁴ .	"Credit": None	"Credit": None	"Credit": None
Proprietary Systems	"Credit": TBD*	"Credit": TBD*	"Credit": TBD*	"Credit": TBD*	"Credit": TBD*
<p>Notes: 1 National Pollutant Removal Database, Version 3.0 (Fraley-McNeil, 2007) 2 Runoff Reduction Technical Memorandum (Hirschman et al., 2008) 3 National Pollutant Removal Database, Version 2.0 (Winer, 2000) 4 Georgia Stormwater Management Manual, Volume 2 (ARC, 2001) # Load reduction estimates are based on a very limited amount of data and should be considered to be provisional estimates. * Information about how specific proprietary devices and systems can be used to help satisfy the stormwater management criteria must be provided by the manufacturer and should be verified using independently-reviewed performance monitoring data and calculations. See Appendix D for more information about monitoring the performance of individual stormwater management practices.</p>					

6.3.4.7 Step 4.7: Check to See If Stormwater Management Criteria Have Been Met

Once stormwater management practices have been applied to a development site, site planning and design teams should check to make sure that all of the SWM Criteria that apply to the site have been completely satisfied. If the SWM Criteria have not been met, teams will need to go back to the stormwater management concept plan and apply additional low impact development and stormwater management practices to further *reduce* and *manage* post-construction stormwater runoff rates, volumes and pollutant loads on the development site.

On many development sites, the process of developing a stormwater management concept plan will be an iterative process. When compliance with the SWM Criteria presented in this CSS is not achieved on the first try, site planning and design teams should return to earlier steps in process to explore alternative site layouts and different combinations of green infrastructure and stormwater management practices. By periodically checking to see if the SWM Criteria that apply to the development site have been met (e.g., Step 4.3, Step 4.5), they can significantly reduce the amount of time that this iterative site design process will take.

If the SWM Criteria presented in this CSS cannot, due to site characteristics or constraints, be satisfied through the use of *on-site* green infrastructure and stormwater management practices, site planning and design teams may be able to achieve compliance by implementing or contributing to an *off-site* stormwater management project. Off-site projects can be an extremely attractive compliance option on redevelopment sites where space for on-site green infrastructure and stormwater management practices is extremely limited. If a developer is interested in using an off-site stormwater management project to help satisfy the SWM Criteria presented in this CSS, they are encouraged to consult with the local development review authority.

6.3.4.8 Step 4.8: Finalize Stormwater Management Concept Plan

Once the SWM Criteria that apply to the development site have been completely satisfied, the next step in the process of developing a stormwater management concept plan is to finalize the plan. In accordance with SP&D Criteria #3 (Section 4.3.3), the final version of the stormwater management concept plan should illustrate the layout of the proposed development project and should show, in general, how post-construction stormwater runoff will be managed on the development site. It is *recommended* that the stormwater management concept plan include all of the information outlined in Section 4.3.3.

The stormwater management concept plan should be submitted to the local development review authority prior to the preparation and submittal of a stormwater management design plan (Section 6.3.6). This provides the local development review authority with an opportunity to provide feedback on the proposed post-construction stormwater management before additional resources are used to create a more detailed stormwater management plan.

6.3.5 Step 5: Consultation Meeting

Once a stormwater management concept plan has been created, it is *recommended* that the site planning and design team hold a consultation meeting with the local development review authority. This meeting, which should occur right after completion of the stormwater management concept plan, provides an opportunity to discuss the proposed development project and the approach that was used to satisfy the stormwater management and site planning and design criteria that apply to the development site. If representatives from appropriate state and federal agencies are able to attend the meeting, it can also be to review

and discuss the state and federal regulations (e.g., Coastal Marshlands Protection Act, Georgia Erosion and Sediment Control Act, Clean Water Act, Endangered Species Act) that apply to the proposed development project.

If possible, the consultation meeting should take place on the development site after submittal, but prior to approval, of the *stormwater management concept plan*. When conducted on the development site, the consultation meeting can be used to verify site conditions and the feasibility of the proposed *stormwater management concept plan*.

6.3.6 Step 6: Prepare Stormwater Management Design Plan

Subsequent to review and approval of the stormwater management concept plan, the site planning and design team should prepare a stormwater management design plan. In accordance with SP&D Criteria #4 (Section 4.3.4), the stormwater management design plan should detail how post-construction stormwater runoff will be managed on the development site and should include maps, narrative descriptions and design calculations (e.g., hydrologic and hydraulic calculations) that show how the stormwater management and site planning and design criteria that apply to the development project have been met. It is *recommended* that the stormwater management design plan include all of the information outlined in Section 4.3.4.

The stormwater management design plan should be submitted to the local development review authority for review and approval. The following information should be submitted to the local development review authority along with the stormwater management design plan:

- Plan preparer certification (Box 6.2)

Box 6.2: Example Plan Preparer Certification

"I, (NAME OF PROFESSIONAL), a Registered (PROFESSIONAL ENGINEER/LAND SURVEYOR/LANDSCAPE ARCHITECT) in the state of Georgia, hereby certify that this stormwater management design plan for the project known as (PROJECT NAME), in (CITY NAME), (COUNTY NAME), Georgia, has been prepared under my supervision, and, in my opinion, meets the stormwater management and site planning and design criteria presented in the Coastal Stormwater Supplement. This (DAY) day of (MONTH), (YEAR)."

- Owner/developer certification (Box 6.3)

Box 6.3: Example Owner/Developer Certification

"I, (NAME OF OWNER/DEVELOPER), hereby certify that all clearing, grading, construction and land disturbing activities for the project known as (PROJECT NAME), in (CITY NAME), (COUNTY NAME), Georgia, will be performed according this stormwater management design plan. This (DAY) day of (MONTH), (YEAR)."

- Downstream analysis, prepared in accordance with SP&D Criteria #5 (Section 4.3.5)
- Stormwater management inspection and maintenance plan, prepared in accordance with SP&D Criteria #6 (Section 4.3.6)
- Erosion and sediment control plan, prepared in accordance with SP&D Criteria #7 (Section 4.3.7)
- Landscaping plan, prepared in accordance with SP&D Criteria #8 (Section 4.3.8)
- If necessary, stormwater pollution prevention plan, prepared in accordance with SP&D Criteria #9 (Section 4.3.9)

A copy of the stormwater management concept plan should be submitted along with the stormwater management design plan. The stormwater management design plan should be consistent with the stormwater management concept plan. If any significant changes were made to the plan of development, the local development review authority may ask for a written statement providing rationale for any changes that were made.

It is *recommended* that the site planning and design team apply for any applicable state or federal permits (e.g., Coastal Marshlands Protection Act, Georgia Erosion and Sediment Control Act, Clean Water Act, Endangered Species Act) prior to, or in conjunction with, the submittal of the stormwater management design plan to the local development review authority. In some cases, state or federal agencies or the local development review authority may require that the stormwater management design plan be changed or revised. This may lengthen the amount of time that it takes to complete the site planning and design process. However, if the six-step *stormwater management planning and design process* outlined above (Figure 6.5) is used to create the stormwater management design plan, there is a good chance that permits will be more quickly obtained from local, state and federal review agencies.

6.3.7 Beyond the Stormwater Management Design Plan

Once the stormwater management design plan has been reviewed and approved by the local development review authority and any applicable state or federal agencies, performance bonds may be set and placed, contractors retained and construction initiated. During the construction phase, the development site is typically inspected on a regular basis by the local development review authority to ensure that all roadways, parking areas, buildings, utilities and other infrastructure, including all green infrastructure and stormwater management practices, are being built in accordance with the approved stormwater management design plan and that all primary and secondary conservation areas are being adequately protected from the land development process.

Once construction is complete, final inspections typically take place to ensure that all roadways, parking areas, buildings, utilities and other infrastructure, including the post-construction stormwater management system, were built according to the approved final plan. As-built plans are also typically prepared and executed during this phase. If a development project passes all final inspections, an occupancy permit may be issued for the project.

6.4 Meeting the Stormwater Management and Site Planning and Design Criteria on Local Road, Highway and Bridge Development Projects

Since they are often designed to discharge stormwater runoff directly into streams, wetlands and other aquatic resources, local road, highway and bridge development projects can have significant negative impacts on the valuable aquatic resources of coastal Georgia. Without an effort to control and minimize these impacts, these development projects have the potential to significantly impair the very natural resources that contribute so greatly to the region's natural beauty, economic well-being and quality of life.

Although the integrated, green infrastructure-based approach to natural resource protection, stormwater management and site design detailed in this CSS can be used to help balance the protection of coastal Georgia's valuable terrestrial and aquatic resources with local road, highway and bridge development projects, managing post-construction stormwater runoff on these projects typically presents some challenges for site planning and design teams, including:

- The need to manage the significant stormwater runoff volumes generated on impervious roadway surfaces
- The need to locate stormwater management practices in a limited amount of space (e.g., rights-of-way)
- The need to manage stormwater runoff while maintaining safe driving conditions
- The need to manage and contain potential spills

Despite these challenges, many of the natural resource protection and stormwater management practices and techniques discussed above can be successfully applied on local road, highway and bridge development projects. However, there are a number of site characteristics and constraints that should be considered when planning and designing of one of these projects to ensure that the prescribed green infrastructure and stormwater management practices will continue to function, as designed, over time (PA DEP, 2006):

- Roadway runoff typically contains higher pollutant loads than stormwater runoff from other urban land uses (Bannerman et al., 1993, Steuer et al., 1997). Sediment loads can be especially high on dirt and gravel roads. Consequently, roadway runoff should *not* be managed with infiltration practices, unless pretreatment is used to reduce sediment loads before stormwater runoff reaches them. Infiltration practices that are applied to local road, highway and bridge development projects must be preceded by green infrastructure or stormwater management practices that can significantly reduce sediment loads, such as:
 - Undisturbed Natural Areas
 - Vegetated Filter Strips
 - Grass Channels
 - Swales
 - Bioretention Areas
 - Filtration Practices

Using green infrastructure and stormwater management practices that reduce sediment loads upstream of infiltration practices helps reduce the risk of clogging and practice failure.

- Grass channels and swales can be highly effective at providing both stormwater conveyance and stormwater runoff reduction. Because they can typically be designed to fit within the right-of-way, they are ideal for use on local road, highway and bridge development projects. However, they must be properly designed to prevent erosion and reduce the amount of maintenance that they will require over time. Additional information about these practices, including information about their proper application and design, is provided in Sections 7.8 and 8.6 of this CSS.
- The potential for spills should be considered during the planning and design process used for local road, highway and bridge development projects. While it is not practical to design for spill containment on all local roads and highways, the site designer should at least consider the potential for spills and the remedial actions that will become necessary should a spill occur.

Many green infrastructure and stormwater management practices, including filter strips, swales, filtration and infiltration practices and bioretention areas, will require significant maintenance or complete replacement after a spill occurs. While this may discourage the site designer from using these practices on local road development projects where

spills are a concern, the relatively minor cost of replacing these stormwater management practices is worth the spill protection they provide. The alternative to using these green infrastructure and stormwater management practices is conveying the pollution generated by spills directly to streams, wetlands and other aquatic resources through the storm drain system, which can result in very high clean up and remediation costs.

- Increased stormwater runoff temperatures can result from local road, highway and bridge development projects. As stormwater runoff moves over these impervious surfaces, it increases in temperature. As documented in Section 3.3.2, when this “heated” stormwater runoff is conveyed into a river, stream, wetland or other aquatic resource, it can decrease the amount of dissolved oxygen contained within the water column, which reduces the amount of oxygen available to aquatic organisms. Consequently, site planning and design teams working on local road, highway and bridge development projects should consider the use of green infrastructure and stormwater management practices that promote infiltration and reduce stormwater runoff temperatures, including:
 - Protect Primary Conservation Areas
 - Protect Secondary Conservation Areas
 - Reduce Clearing and Grading Limits
 - Soil Restoration
 - Site Reforestation/Revegetation
 - Vegetated Filter Strips
 - Grass Channels
 - Swales
 - Bioretention Areas
 - Infiltration Practices

There are certain green infrastructure and stormwater management practices that work particularly well on local road development projects, others that work particularly well on local highway development projects and still others that work particularly well on local bridge development projects. The green infrastructure and stormwater management practices that can be most readily applied to each of these different types of development projects are briefly described below.

6.4.1 Local Highway Development Projects

Local highways are often designed with grass shoulders and often include vegetated medians, providing plenty of room for the use of green infrastructure and stormwater management practices. Opportunities to use infiltration practices on highway development projects, however, may be limited due to extensive grading and earthwork, as highway rights-of-way are often subject to significant compaction. However, the use of infiltration practices should not automatically be ruled out on local highway development projects, and should be considered on a case-by-case basis.

Because they can typically be designed to fit within medians and shoulders, swales, grass channels and vegetated filter strips are ideal for use on local highway development projects. They can be combined with bioretention areas located within the right-of-way to provide additional runoff reduction or with larger stormwater management practices, such as stormwater ponds and stormwater wetlands, to manage the peak stormwater runoff rates and volumes generated by larger, less frequent storm events.

6.4.2 Local Bridge Development Projects

Since bridges are built directly over streams and other aquatic resources, there is often little opportunity to use green infrastructure and stormwater management practices on these development projects. However, the use of filtration practices, particularly perimeter sand filters, as well as proprietary water quality management practices should be considered, as these stormwater management practices can be used to treat stormwater runoff before it is discharged directly from a bridge deck into a stream, wetland or other aquatic resource.

6.4.3 Local Street and Roadway Development Projects

Local street and roadway development projects are ideal for the use of green infrastructure and stormwater management practices. Although the goal of these natural resource protection and stormwater management practices and techniques is not just to minimize the creation of new impervious and disturbed pervious cover, a number of better site design techniques do work particularly well on these development projects, including:

- Reduce Clearing and Grading Limits
- Reduce Roadway Lengths and Widths
- Reduce Sidewalk Lengths and Widths
- Use Fewer or Alternative Cul-de-Sacs

Unfortunately, the use of some of these better site design techniques may be restricted by local “development rules.” Site planning and design teams are encouraged to identify any local restrictions that would preclude the use of any of these better site design techniques on local street and roadway development projects.

Another site design technique that works particularly well on local street and roadway development projects is to use the right-of-way, rather than curbs and gutters, to manage post-construction stormwater runoff. Open section roadways can be used in place of closed section roadways to allow stormwater runoff to sheet flow off of the pavement surface and into grass channels, dry swales, vegetated filter strips or undisturbed pervious areas, all of which provide significant reductions in post-construction stormwater runoff rates, volumes and pollutant loads. Other green infrastructure and stormwater management practices that can be applied on local street and roadway development projects include:

- Permeable Pavement
- Bioretention Areas
- Filtration Practices
- Infiltration Practices
- Wet Swales

6.4.4 Local Back (Dirt and Gravel) Road Development Projects

A significant portion of coastal Georgia is served by unpaved dirt and gravel roads. These roads, and their associated stormwater conveyance systems (e.g., ditches, culverts), are prone to erosion and can generate significant amounts of stormwater pollution. In fact, according to the Georgia Department of Natural Resources Environmental Protection Division (GA EPD), the sediment generated on local dirt and gravel roads ranks second only to row cropping as a source of sediment in the state of Georgia (Pine Country RCDC, 2008). Consequently, it is important to manage the post-construction stormwater runoff generated on these unpaved surfaces to help protect the streams, wetlands and other aquatic resources of coastal Georgia

from the negative impacts of the land development process. Although all of the techniques discussed below can be used to manage the stormwater runoff generated on these unpaved surfaces, additional guidance on managing local dirt and gravel road development projects can be obtained through the Georgia Better Back Roads Program. Additional information about this program can be found on the following website: <http://www.tworiversrcd.org/GABBR.htm>.

One of the simplest ways to control and minimize the negative impacts of local back road development projects is to use better site planning and design techniques during their design. By working with existing topography and natural drainage divides and patterns, roadway planning and design teams can minimize the need for earthwork, as well as the need for culverts and stream crossings.

Another simple technique that can be used to reduce the negative impacts of local back road development projects is to crown the roadways to prevent water from ponding on the roadway surface itself. On these crowned dirt and gravel roadways, stormwater runoff can be allowed to sheet flow off of the roadway surface and into undisturbed natural areas, vegetated filter strips, grass channels and dry swales, all of which provide significant reductions in post-development stormwater runoff rates, volumes and pollutant loads. Moving stormwater off of the surface of these roads also helps prevent the formation of erosive conditions.

Care should be taken to ensure that the green infrastructure and stormwater management practices that are designed to “receive” stormwater runoff from dirt and gravel roadways are properly designed and maintained. Any vegetation that is planted within these green infrastructure and stormwater management practices should be maintained over time, as it helps stabilize soils and prevent soil erosion. Because of the significant sediment loads that these roadways can generate, runoff from dirt and gravel roadways *should not* be managed with infiltration practices, unless pretreatment is used to reduce sediment loads before stormwater runoff reaches these infiltration practices.

References

- Atlanta Regional Commission (ARC). 2001. *Georgia Stormwater Management Manual*. Volume 2. Technical Handbook. Atlanta Regional Commission. Atlanta, GA. Available Online: <http://www.georgiastormwater.com/>.
- Bannerman, R., D. Owens, R. Dodds and N. Hornewer. 1993. "Sources of Pollutants in Wisconsin Stormwater." *Water Science Technology*. 28(3-5): 241-259.
- Center for Watershed Protection (CWP). 1998. *Better Site Design: A Handbook for Changing Development Rules in Your Community*. Center for Watershed Protection. Ellicott City, MD. Available Online: http://www.cwp.org/Resource_Library/Controlling_Runoff_and_Discharges/sm.htm.
- Fraley-McNeil, L., T. Schueler and R. Winer. 2007. *National Pollutant Removal Performance Database*. Version 3.0. Center for Watershed Protection. Ellicott City, MD. Available Online: http://www.cwp.org/Resource_Library/Controlling_Runoff_and_Discharges/sm.htm.
- Georgia Department of Natural Resources Wildlife Resources Division (WRD). 2005. *A Comprehensive Wildlife Conservation Strategy for Georgia*. Georgia Department of Natural Resources. Wildlife Resources Division. Social Circle, GA. Available Online: <http://www1.gadnr.org/cwcs/Documents/strategy.html>.
- Hirschman, D., K. Collins and T. Schueler. 2008. *Runoff Reduction Method*. Center for Watershed Protection. Ellicott City, MD. Available Online: http://www.cwp.org/Resource_Library/Center_Docs/SW/RRTechMemo.pdf.
- MacMullan, E. and S. Reich. 2007. *The Economics of Low Impact Development: A Literature Review*. ECONorthwest. Eugene, OR. Available Online: http://www.econw.com/reports/ECONorthwest_Low-Impact-Development-Economics-Literature-Review.pdf.
- Merrill, T.R., Coastal Georgia Regional Development Center (CGRDC) and EMC Engineering Services, Inc. 2006. *Green Growth Guidelines: A Low Impact Development Strategy for Coastal Georgia*. Prepared for: Georgia Department of Natural Resources (DNR) Coastal Management Program. Brunswick, GA. Available Online: <http://crd.dnr.state.ga.us/content/displaycontent.asp?txtDocument=969>.
- Pennsylvania Department of Environmental Protection (PA DEP). 2006. *Pennsylvania Stormwater Best Management Practices Manual*. Pennsylvania Department of Environmental Protection. Bureau of Watershed Management. Available Online: <http://www.depweb.state.pa.us/watershedmgmt/site/default.asp>.
- Pine Country Research Conservation and Development Council (Pine Country RCDC). 2008. *Area Plan*. Pine Country Research Conservation and Development Council. Soperton, GA. Available Online: <http://www.pinecountryrcd.org/information.htm>.
- Prince George's County, MD. 1999. *Low-Impact Development Design Strategies: An Integrated Design Approach*. Prince George's County, MD. Department of Environmental Resources. Programs and Planning Division. Largo, MD. Available Online: <http://www.epa.gov/nps/lidnatl.pdf>.

- Steuer, J., W. Selbig, N. Hornewer and J. Prey. 1997. *Sources of Contamination in an Urban Basin in Marquette, Michigan and an Analysis of Concentrations, Loads and Data Quality*. U.S. Geological Survey. Water Resources Investigation Report No. 97-4242.
- U.S. Environmental Protection Agency (US EPA). 2008. "Environmental Benefits of Green Infrastructure." *Managing Wet Weather with Green Infrastructure*. <http://cfpub.epa.gov/npdes/greeninfrastructure/information.cfm#enviroben>. Accessed: June 27, 2008.
- U.S. Environmental Protection Agency (US EPA). 2007. *Reducing Stormwater Costs Through Low Impact Development (LID) Strategies and Practices*. EPA 841-F-07-006. U.S. Environmental Protection Agency. Washington, DC. Available Online: <http://www.epa.gov/owow/nps/lid/costs07/>.
- Winer-Skonovd, R., D. Hirschman, H.Y. Kwon and C. Swann. 2006. *Synthesis of Existing Cost Information for LID vs. Conventional Practices*. Center for Watershed Protection. Ellicott City, MD.
- Winer, R. 2000. *National Pollutant Removal Performance Database*. 2nd Edition. Center for Watershed Protection. Ellicott City, MD. Available Online: http://www.cwp.org/Resource_Library/Controlling_Runoff_and_Discharges/sm.htm.

THIS PAGE INTENTIONALLY LEFT BLANK

7.0 Green Infrastructure Practices

7.1 Overview

Green infrastructure practices are natural resource protection and stormwater management practices and techniques (i.e., better site planning and design techniques, low impact development practices) that can be used to help *prevent* increases in post-construction stormwater runoff rates, volumes and pollutant loads on development sites. Although the term *green infrastructure* can mean different things to different people (Box 4.1), in this Coastal Stormwater Supplement (CSS), the term *green infrastructure practices* has been succinctly defined as the combination of three complementary, but distinct, groups of natural resource protection and stormwater management practices and techniques:

- Better Site Planning Techniques: Techniques that are used to protect valuable aquatic and terrestrial resources from the direct impacts of the land development process.
- Better Site Design Techniques: Techniques that are used to minimize land disturbance and the creation of new impervious and disturbed pervious cover.
- Low Impact Development Practices: Small-scale stormwater management practices that are used to disconnect impervious and disturbed pervious surfaces from the storm drain system and reduce post-construction stormwater runoff rates, volumes and pollutant loads.

Together, these *green infrastructure practices* can be used to not only help protect coastal Georgia's valuable terrestrial and aquatic resources from the direct impacts of the land development process, but also help maintain pre-development site hydrology and reduce post-construction stormwater runoff rates, volumes and pollutant loads. They also provide a number of other environmental and economic benefits, including (US EPA, 2008):

- Reduced Sanitary and Combined Sewer Overflow Events: By reducing stormwater runoff rates and volumes, green infrastructure practices help reduce the magnitude and frequency of combined and sanitary sewer overflow events.
- Urban Heat Island Mitigation: The trees, shrubs and other vegetation associated with green infrastructure practices create shade, reflect solar radiation and emit water vapor, all of which create cooler temperatures in urban environments and help mitigate the impacts of urban heat islands.
- Reduced Energy Demand: The trees, shrubs and other vegetation associated with green infrastructure practices help lower ambient air temperatures in urban areas and, when incorporated on and around buildings, help insulate buildings from temperature swings, decreasing the amount of energy used for heating and cooling.
- Improved Air Quality: The trees, shrubs and other vegetation associated with green infrastructure practices improve air quality by removing many airborne pollutants from the atmosphere through the processes of leaf uptake and contact removal.
- Increased Carbon Sequestration: The trees, shrubs and other vegetation associated with green infrastructure practices are able to capture and remove carbon from the atmosphere through the processes of photosynthesis and respiration.

- Improved Aesthetics: The trees, shrubs and other vegetation associated with green infrastructure practices improve aesthetics, provide recreational opportunities and wildlife habitat and increase property values (MacMullan and Reich, 2007, US EPA, 2007, Winer-Skonovd et al., 2006).
- Improved Human Health: An increasing number of studies suggest that the trees, shrubs and other vegetation associated with green infrastructure practices can have a positive impact on human health. Recent research has linked the presence of trees, plants and other vegetation to reduced levels of crime and violence, a stronger sense of community, improved academic performance and even reductions in the symptoms associated with attention deficit and hyperactivity disorders (Faber-Taylor and Kuo, 2006, Kuo, 2003, Sullivan et al., 2003, Kuo and Sullivan, 2001, Taylor et al., 1998).

This Section provides additional information about using these *green infrastructure practices* to help satisfy the stormwater management and site planning and design criteria presented in this CSS. Together with *stormwater management practices*, which can be used to *manage* post-construction stormwater runoff rates, volumes and pollutant loads, green infrastructure practices can be used to help control and minimize the negative impacts of land development and nonpoint source pollution. They are an important part of the integrated, green infrastructure-based approach to natural resource protection, stormwater management and site design presented in this CSS.

7.2 Recommended Green Infrastructure Practices

The green infrastructure practices *recommended* for use in coastal Georgia include:

Better Site Planning Techniques

- Protect Primary Conservation Areas
- Protect Secondary Conservation Areas

Better Site Design Techniques

- Reduce Clearing and Grading Limits
- Reduce Roadway Lengths and Widths
- Use Fewer or Alternative Cul-de-Sacs
- Reduce Parking Lot Footprints
- Create Landscaping Areas in Parking Lots
- Reduce Driveway Lengths and Widths
- Reduce Sidewalk Lengths and Widths
- Reduce Building Footprints
- Reduce Setbacks and Frontages

Low Impact Development Practices

The low impact development practices *recommended* for use in coastal Georgia have been divided into three groups: (1) alternatives to disturbed pervious surfaces; (2) alternatives to impervious surfaces; and (3) "receiving" low impact development practices. Each of these groups is briefly described below:

Alternatives to Disturbed Pervious Surfaces

These low impact development practices can be used to help restore disturbed pervious surfaces to their pre-development conditions, which decreases post-construction stormwater runoff rates, volumes and pollutant loads. They can be used alone or in combination with one another to restore soils and native vegetative cover in areas that have been or will be disturbed by clearing, grading and other land disturbing activities (Figure 7.1). The alternatives to disturbed pervious surfaces *recommended* for use in coastal Georgia include:

- Soil Restoration
- Site Reforestation/Revegetation



Figure 7.1: Reforestation of a Disturbed Pervious Area

(Source: Center for Watershed Protection)

Alternatives to Impervious Surfaces

These low impact development practices can be used to reduce the amount of “effective” impervious cover found on a development site. They can be used in place of traditional impervious surfaces, such as rooftops (Figure 7.2), parking lots and driveways, to reduce the post-construction stormwater runoff rates, volumes and pollutant loads that these surfaces create. The alternatives to impervious surfaces *recommended* for use in coastal Georgia include:

- Green Roofs
- Permeable Pavement



Figure 7.2: Green Roof Used in Place of a Traditional Impervious Rooftop

(Source: Center for Watershed Protection)

“Receiving” Low Impact Development Practices

These low impact development practices can be used to “receive” and reduce the post-construction stormwater runoff generated on a development site (Figure 7.3). They are designed to slow and temporarily store stormwater runoff, subjecting it to the runoff reducing hydrologic processes of interception, evapotranspiration, infiltration and capture and reuse, before directing it into the stormwater conveyance system. The low impact development practices that can be used to “receive” post-construction stormwater runoff on a development site include:

- Undisturbed Pervious Areas
- Vegetated Filter Strips
- Grass Channels
- Simple Downspout Disconnection



Figure 7.3: Rain Garden Used to “Receive” Stormwater Runoff

(Source: Center for Watershed Protection)

- Rain Gardens
- Stormwater Planters
- Dry Wells
- Rainwater Harvesting
- Bioretention Areas
- Infiltration Practices
- Dry Swales

The remainder of this Section provides additional information about all of these green infrastructure practices, including information about their proper application and design and information about how they can be used to help satisfy the stormwater management and site planning and design criteria presented in this CSS.

7.3 Other Green Infrastructure Practices

7.3.1 New and Innovative Green Infrastructure Practices

The use of new and innovative green infrastructure practices is encouraged in coastal Georgia, provided that their ability to satisfy the stormwater management and site planning and design criteria presented in this CSS has been sufficiently documented. At its discretion, a local development review authority may allow for the use of a green infrastructure practice that is not discussed in this CSS. However, local development review authorities are encouraged not to do so until they are provided with reliable information about practice performance and information about practice design and maintenance requirements.

New and innovative green infrastructure practices will not be added to this CSS until reliable, independently derived performance monitoring data confirm their ability to satisfy the stormwater management and site planning and design criteria presented within. Appendix C outlines a stormwater management monitoring protocol that can be used to help document the performance of new and innovative green infrastructure practices in coastal Georgia.

7.4 Applying Green Infrastructure Practices During the Site Planning & Design Process

A procedure that can be used to apply green infrastructure practices to a development site during the site planning and design process is illustrated in Figure 7.4 and briefly outlined below.

7.4.1 Step 4.1: Use Better Site Planning Techniques

After completing the natural resources inventory (Section 6.3.3), site planning and design teams should be able to identify the primary and secondary conservation areas found on the development site. In accordance with site planning and design criteria #2 (SP&D Criteria #2) (Section 4.3.2), it is *recommended* that:

- (1) The following primary conservation areas, which provide habitat for high priority plant and animal species (Appendix A) and are considered to be high priority habitat areas (WRD, 2005), be protected from the direct impacts of the land development process:

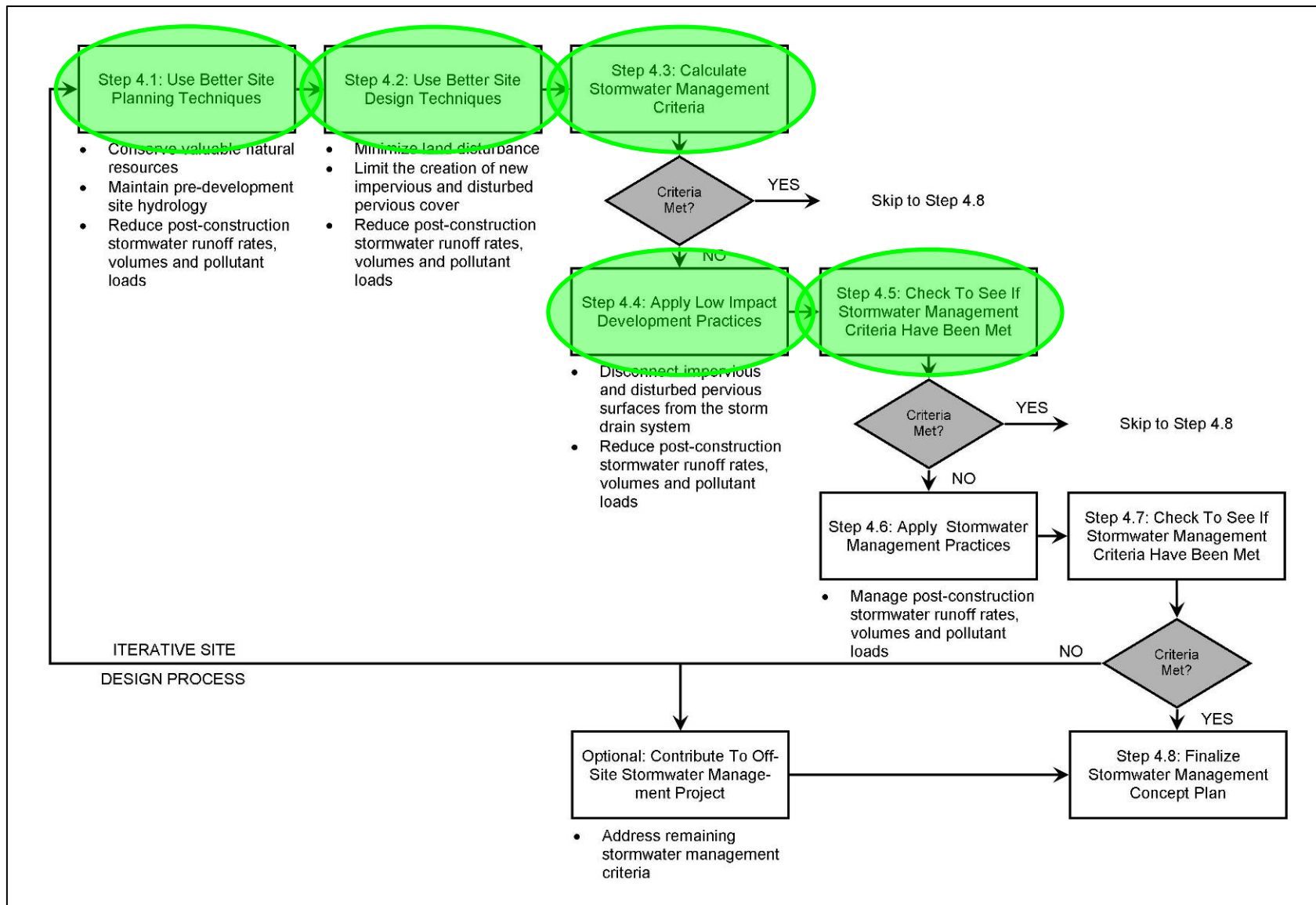

Figure 7.4: Using Green Infrastructure Practices During the Creation of a Stormwater Management Concept Plan

(Source: Center for Watershed Protection)

- Aquatic Resources
 - Rivers
 - Perennial and Intermittent Streams
 - Freshwater Wetlands
 - Tidal Rivers and Streams
 - Tidal Creeks
 - Coastal Marshlands
 - Tidal Flats
 - Scrub-Shrub Wetlands
 - Near Coastal Waters
 - Beaches
- Terrestrial Resources
 - Dunes
 - Maritime Forests
 - Marsh Hammocks
 - Evergreen Hammocks
 - Canebrakes
 - Bottomland Hardwood Forests
 - Beech-Magnolia Forests
 - Pine Flatwoods
 - Longleaf Pine-Wiregrass Savannas
 - Longleaf Pine-Scrub Oak Woodlands
- Other Resources
 - Aquatic Buffers
 - Shellfish Harvesting Areas
 - Other High Priority Habitat Areas

(2) Consideration should be given to protecting the following secondary conservation areas from the direct impacts of the land development process:

- General Resources
 - Natural Drainage Features (e.g., Swales, Basins, Depressional Areas)
 - Erodible Soils
 - Steep Slopes (i.e., Areas with Slopes Greater Than 15%)
 - Trees and Other Existing Vegetation
- Aquatic Resources
 - Groundwater Recharge Areas
 - Wellhead Protection Areas
- Other Resources
 - Floodplains

All primary and secondary conservation areas that will be protected from the direct impacts of the land development process should be clearly identified on the plan of development. They should be maintained in an undisturbed, natural state before, during and after construction, and should be protected in perpetuity through a legally-enforceable conservation instrument (e.g., conservation easement, deed restriction). Additional information about how to apply these better site planning techniques on a development site can be found in Section 7.6.

7.4.2 Step 4.2: Use Better Design Techniques

After completing the natural resources inventory (Section 6.3.3) and using better site planning techniques to protect primary and secondary conservation areas, the site planning and design

team should be able to define the buildable area on the development site. In accordance with SP&D Criteria #2 (Section 4.3.2), it is *recommended* that consideration be given to using better site design techniques to minimize land disturbance and limit the creation of new impervious and disturbed pervious cover within this buildable area. Additional information about these better site design techniques, including information about how to use them on a development site, can be found in Section 7.7.

7.4.3 Step 4.3: Calculate Stormwater Management Criteria

Since the use of better site planning and design techniques can significantly reduce post-construction stormwater runoff rates, volumes and pollutant loads, site planning and design teams need not calculate the stormwater runoff volumes associated with the post-construction stormwater management criteria (SWM Criteria) that apply to a development site until they have completed an initial layout of the proposed development project. This helps provide the site planning and design team with a “blank canvas” during the creation of the development plan, one which is intended to encourage creativity and the use of a variety of better site planning and design techniques during the layout of the proposed development project. Information about calculating the stormwater runoff volumes associated with the SWM Criteria that apply to a development site is provided in Section 5.0, while information about applying the stormwater management “credits” associated with each of the better site planning and design techniques is provided in Sections 7.6-7.7.

Once an initial estimate of the stormwater runoff volumes associated with the SWM Criteria that apply to a development site has been completed, site planning and design teams may want to go back to the development plan and apply additional better site design and planning techniques to further reduce post-construction stormwater runoff rates, volumes and pollutant loads. During this iterative site design process, several alternative development plans can be created and compared with one another to come up with a plan that will best “fit” the character of the site and best meet the SWM Criteria presented in this CSS.

7.4.4 Step 4.4: Apply Low Impact Development Practices

After an initial layout of the proposed development project has been completed using better site planning and design techniques, and an initial estimate of the stormwater runoff volumes associated with the SWM Criteria that apply to a development site has been completed, site planning and design teams should be able to begin distributing low impact development practices across the development site. Many of these practices can be placed in the disturbed and undisturbed pervious areas that were protected earlier in the process through the use of better site planning and design techniques.

At this point in the site planning and design process, a site planning and design team should have a pretty good understanding of the post-construction stormwater runoff rates, volumes and pollutant loads that they will need to manage on the development site. In accordance with SP&D Criteria #2 (Section 4.3.2), it is *recommended* that low impact development practices be used, to the *maximum extent practical*, to reduce these post-construction stormwater runoff rates, volumes and pollutant loads on the development site. Additional information about these low impact development practices, including information about their proper application and design, can be found in Section 7.8.

When applying low impact development practices to a development site, it is important that they be treated just like stormwater management practices. They should be placed in drainage

or maintenance easements and included in all stormwater management system inspection and maintenance plans (SP&D Criteria #6).

7.4.5 Step 4.5: Check to See If Stormwater Management Criteria Have Been Met

By distributing runoff reducing low impact development practices across a development site, and applying the associated stormwater management "credits," it is possible to significantly reduce post-construction stormwater runoff rates, volumes and pollutant loads. Therefore, at this point in the process of creating a plan of development, it is *recommended* that site planning and design teams check to see if the SWM Criteria that apply to the development site have been met. Depending on the number and type of low impact development practices that have been used, the post-construction stormwater runoff rates, volumes and pollutant loads generated on the development site may have been significantly reduced. If so, the need for larger and more costly stormwater management practices, such as wet ponds and stormwater wetlands, may have been significantly reduced or may have been eliminated altogether.

If a site planning and design team finds that the SWM Criteria that apply to a development site have not been completely satisfied, they may want to go back to the development plan to apply additional low impact development practices to further reduce post-construction stormwater runoff rates, volumes and pollutant loads on the development site. In accordance with SWM Criteria #1, if low impact development practices, in combination with the previously applied better site planning and design techniques, cannot, on their own, be used to completely satisfy the stormwater runoff reduction criteria (SWM Criteria #1), or any of the other SWM Criteria, *stormwater management practices* will need to be used on the development site (Section 6.3.4.6). Additional information about using stormwater management practices on a development site, including information about their proper application and design, can be found in Section 8.0.

7.5 Green Infrastructure Practice Selection

A screening process that can be used to help decide what green infrastructure practices should be used on a development site is outlined below. This process is intended to assist site planning and design teams in selecting the most appropriate green infrastructure practices for use on a development site.

In general, the following information should be considered when deciding what green infrastructure practices to use on a development site:

- Ability to Help Satisfy the Stormwater Management Criteria
- Overall Feasibility
- Site Applicability

In addition, site planning and design teams should consider how the following site characteristics and constraints, which are commonly encountered in coastal Georgia, will influence the use of green infrastructure practices on a development site:

- Poorly drained soils, such as hydrologic soil group C and D soils
- Well drained soils, such as hydrologic soil group A and B soils
- Flat terrain
- Shallow water table
- Tidally-influenced drainage

Additional information on a step-wise process that can be used to decide what green infrastructure practices to use on a development site is provided below. The process uses three screening matrices to evaluate the feasibility and applicability of the various green infrastructure practices recommended for use in coastal Georgia.

7.5.1 Step 1: Evaluate Ability to Help Satisfy the Stormwater Management Criteria

Through the use of the first screening matrix (Table 7.1), site planning and design teams can evaluate how each of the green infrastructure practices can be used to help satisfy the post-construction stormwater management criteria that apply to a development site. Additional information about each of the screening categories included in the matrix is provided below.

- Stormwater Runoff Reduction: This column indicates the stormwater management “credit” that can be applied toward the stormwater runoff reduction criteria (SWM Criteria #1) if the green infrastructure practice is used on the development site.
- Water Quality Protection: This column indicates the stormwater management “credit” that can be applied toward the water quality protection criteria (SWM Criteria #2) if the green infrastructure practice is used on the development site.
- Aquatic Resource Protection: This column indicates the stormwater management “credit” that can be applied toward the aquatic resource protection criteria (SWM Criteria #3) if the green infrastructure practice is used on the development site.
- Overbank Flood Protection: This column indicates the stormwater management “credit” that can be applied toward the overbank flood protection criteria (SWM Criteria #4) if the green infrastructure practice is used on the development site.
- Extreme Flood Protection: This column indicates the stormwater management “credit” that can be applied toward the extreme flood protection criteria (SWM Criteria #5) if the green infrastructure practice is used on the development site.

Table 7.1: How Green Infrastructure Practices Can Be Used to Help Satisfy the Stormwater Management Criteria

Green Infrastructure Practice	Stormwater Runoff Reduction	Water Quality Protection	Aquatic Resource Protection	Overbank Flood Protection	Extreme Flood Protection
Better Site Planning Techniques					
Protect Primary Conservation Areas	"Credit": Subtract any <i>primary and secondary conservation areas</i> from the total site area when calculating the runoff reduction volume (RR _v) that applies to a development site.	"Credit": Subtract any <i>primary and secondary conservation areas</i> from the total site area when calculating the runoff reduction volume (RR _v) that applies to a development site.	"Credit": Assume that the post-development hydrologic conditions of any <i>primary and secondary conservation areas</i> are equivalent to the pre-development hydrologic conditions for those same areas.	"Credit": Assume that the post-development hydrologic conditions of any <i>primary and secondary conservation areas</i> are equivalent to the pre-development hydrologic conditions for those same areas.	"Credit": Assume that the post-development hydrologic conditions of any <i>primary and secondary conservation areas</i> are equivalent to the pre-development hydrologic conditions for those same areas.
Protect Secondary Conservation Areas					
Better Site Design Techniques					
Reduce Clearing and Grading Limits	"Credit": Subtract 50% of any <i>undisturbed pervious areas</i> from the total site area when calculating the runoff reduction volume (RR _v) that applies to a development site.	"Credit": Subtract 50% of any <i>undisturbed pervious areas</i> from the total site area when calculating the runoff reduction volume (RR _v) that applies to a development site.	"Credit": Assume that the post-development hydrologic conditions of any <i>undisturbed pervious areas</i> are equivalent to the pre-development hydrologic conditions for those same areas.	"Credit": Assume that the post-development hydrologic conditions of any <i>undisturbed pervious areas</i> are equivalent to the pre-development hydrologic conditions for those same areas.	"Credit": Assume that the post-development hydrologic conditions of any <i>undisturbed pervious areas</i> are equivalent to the pre-development hydrologic conditions for those same areas.
Reduce Roadway Lengths and Widths	"Credit": "Self-crediting," in that minimizing the creation of new impervious cover results in a lower volumetric runoff coefficient (R _v) and, consequently, a lower runoff reduction volume (RR _v) on a development site.	"Credit": "Self-crediting," in that minimizing the creation of new impervious cover results in a lower volumetric runoff coefficient (R _v) and, consequently, a lower runoff reduction volume (RR _v) on a development site.	"Credit": "Self-crediting," in that minimizing the creation of new impervious cover results in a lower runoff curve number (CN) and, consequently, a lower aquatic resource protection volume (ARP _v) on a development site.	"Credit": "Self-crediting," in that minimizing the creation of new impervious cover results in a lower runoff curve number (CN) and, consequently, a lower overbank peak discharge (Q _{p25}) on a development site.	"Credit": "Self-crediting," in that minimizing the creation of new impervious cover results in a lower runoff curve number (CN) and, consequently, a lower extreme peak discharge (Q _{p100}) on a development site.
Use Fewer or Alternative Cul-de-Sacs					
Reduce Parking Lot Footprints					
Create Landscaping Areas in Parking Lots					
Reduce Driveway Lengths and Widths					
Reduce Sidewalk Lengths and Widths					
Reduce Building Footprints					
Reduce Setbacks and Frontages					

Table 7.1: How Green Infrastructure Practices Can Be Used to Help Satisfy the Stormwater Management Criteria

Green Infrastructure Practice	Stormwater Runoff Reduction	Water Quality Protection	Aquatic Resource Protection	Overbank Flood Protection	Extreme Flood Protection
Low Impact Development Practices					
Alternatives to Disturbed Pervious Surfaces					
Soil Restoration	"Credit": Subtract 50% of any <i>restored pervious areas</i> from the total site area and re-calculate the runoff reduction volume (RR _v) that applies to a development site.	"Credit": Subtract 50% of any <i>restored pervious areas</i> from the total site area and re-calculate the runoff reduction volume (RR _v) that applies to a development site.	"Credit": Assume that the post-development hydrologic conditions of any <i>restored pervious areas</i> are equivalent to those of open space in good condition.	"Credit": Assume that the post-development hydrologic conditions of any <i>restored pervious areas</i> are equivalent to those of open space in good condition.	"Credit": Assume that the post-development hydrologic conditions of any <i>restored pervious areas</i> are equivalent to those of open space in good condition.
Site Reforestation/ Revegetation	"Credit": Subtract 50% of any <i>reforested/revegetated areas</i> from the total site area and re-calculate the runoff reduction volume (RR _v) that applies to a development site.	"Credit": Subtract 50% of any <i>reforested/revegetated areas</i> from the total site area and re-calculate the runoff reduction volume (RR _v) that applies to a development site.	"Credit": Assume that the post-development hydrologic conditions of any <i>reforested/revegetated areas</i> are equivalent to those of a similar cover type in fair condition.	"Credit": Assume that the post-development hydrologic conditions of any <i>reforested/revegetated areas</i> are equivalent to those of a similar cover type in fair condition.	"Credit": Assume that the post-development hydrologic conditions of any <i>reforested/revegetated areas</i> are equivalent to those of a similar cover type in fair condition.
Soil Restoration with Site Reforestation/ Revegetation	"Credit": Subtract 100% of any <i>restored and reforested/revegetated areas</i> from the total site area and re-calculate the runoff reduction volume (RR _v) that applies to a development site.	"Credit": Subtract 100% of any <i>restored and reforested/revegetated areas</i> from the total site area and re-calculate the runoff reduction volume (RR _v) that applies to a development site.	"Credit": Assume that the post-development hydrologic conditions of any <i>restored and reforested/revegetated areas</i> are equivalent to those of a similar cover type in good condition.	"Credit": Assume that the post-development hydrologic conditions of any <i>restored and reforested/revegetated areas</i> are equivalent to those of a similar cover type in good condition.	"Credit": Assume that the post-development hydrologic conditions of any <i>restored and reforested/revegetated areas</i> are equivalent to those of a similar cover type in good condition.
Alternatives to Impervious Surfaces					
Green Roofs	"Credit": Reduce the runoff reduction volume (RR _v) conveyed through a <i>green roof</i> by 60%.	"Credit": Reduce the runoff reduction volume (RR _v) conveyed through a <i>green roof</i> by 60%.	"Credit": Proportionally adjust the post-development runoff curve number (CN) to account for the runoff reduction provided by a <i>green roof</i> when calculating the aquatic resource protection volume (ARP _v) on a development site.	"Credit": Proportionally adjust the post-development runoff curve number (CN) to account for the runoff reduction provided by a <i>green roof</i> when calculating the overbank peak discharge (Q _{p25}) on a development site.	"Credit": Proportionally adjust the post-development runoff curve number (CN) to account for the runoff reduction provided by a <i>green roof</i> when calculating the extreme peak discharge (Q _{p100}) on a development site.

Table 7.1: How Green Infrastructure Practices Can Be Used to Help Satisfy the Stormwater Management Criteria

Green Infrastructure Practice	Stormwater Runoff Reduction	Water Quality Protection	Aquatic Resource Protection	Overbank Flood Protection	Extreme Flood Protection
Permeable Pavement, No Underdrain	<p>“Credit”: Subtract 100% of the storage volume provided by a non-underdrained <i>permeable pavement system</i> from the runoff reduction volume (RR_v) conveyed through the <i>system</i>.</p>	<p>“Credit”: Subtract 100% of the storage volume provided by a non-underdrained <i>permeable pavement system</i> from the runoff reduction volume (RR_v) conveyed through the <i>system</i>.</p>	<p>“Credit”: Proportionally adjust the post-development runoff curve number (CN) to account for the runoff reduction provided by a <i>permeable pavement system</i> when calculating the aquatic resource protection volume (ARP_v) on a development site.</p>	<p>“Credit”: Proportionally adjust the post-development runoff curve number (CN) to account for the runoff reduction provided by a <i>permeable pavement system</i> when calculating the overbank peak discharge (Q_{p25}) on a development site.</p>	<p>“Credit”: Proportionally adjust the post-development runoff curve number (CN) to account for the runoff reduction provided by a <i>permeable pavement system</i> when calculating the extreme peak discharge (Q_{p100}) on a development site.</p>
Permeable Pavement, Underdrain	<p>“Credit”: Subtract 50% of the storage volume provided by an underdrained <i>permeable pavement system</i> from the runoff reduction volume (RR_v) conveyed through the <i>system</i>.</p>	<p>“Credit”: Subtract 50% of the storage volume provided by an underdrained <i>permeable pavement system</i> from the runoff reduction volume (RR_v) conveyed through the <i>system</i>.</p>			
“Receiving” Low Impact Development Practices					
Undisturbed Pervious Areas, A/B Soils	<p>“Credit”: Reduce the runoff reduction volume (RR_v) conveyed through an <i>undisturbed pervious area</i> located on A/B soils by 90%.</p>	<p>“Credit”: Reduce the runoff reduction volume (RR_v) conveyed through an <i>undisturbed pervious area</i> located on A/B soils by 90%.</p>	<p>“Credit”: Proportionally adjust the post-development runoff curve number (CN) to account for the runoff reduction provided by an <i>undisturbed pervious area</i> when calculating the aquatic resource protection volume (ARP_v) on a development site.</p>	<p>“Credit”: Proportionally adjust the post-development runoff curve number (CN) to account for the runoff reduction provided by an <i>undisturbed pervious area</i> when calculating the overbank peak discharge (Q_{p25}) on a development site.</p>	<p>“Credit”: Proportionally adjust the post-development runoff curve number (CN) to account for the runoff reduction provided by an <i>undisturbed pervious area</i> when calculating the extreme peak discharge (Q_{p100}) on a development site.</p>
Undisturbed Pervious Areas, C/D Soils	<p>“Credit”: Reduce the runoff reduction volume (RR_v) conveyed through an <i>undisturbed pervious area</i> located on C/D soils by 60%.</p>	<p>“Credit”: Reduce the runoff reduction volume (RR_v) conveyed through an <i>undisturbed pervious area</i> located on C/D soils by 60%.</p>			

Table 7.1: How Green Infrastructure Practices Can Be Used to Help Satisfy the Stormwater Management Criteria

Green Infrastructure Practice	Stormwater Runoff Reduction	Water Quality Protection	Aquatic Resource Protection	Overbank Flood Protection	Extreme Flood Protection
Vegetated Filter Strips, A/B or Amended Soils	"Credit": Reduce the runoff reduction volume (RR _v) conveyed through a <i>vegetated filter strip</i> located on A/B or amended soils by 60%.	"Credit": Reduce the runoff reduction volume (RR _v) conveyed through a <i>vegetated filter strip</i> located on A/B or amended soils by 60%.	"Credit": Proportionally adjust the post-development runoff curve number (CN) to account for the runoff reduction provided by a <i>vegetated filter strip</i> when calculating the aquatic resource protection volume (ARP _v) on a development site.	"Credit": Proportionally adjust the post-development runoff curve number (CN) to account for the runoff reduction provided by a <i>vegetated filter strip</i> when calculating the overbank peak discharge (Q _{p25}) on a development site.	"Credit": Proportionally adjust the post-development runoff curve number (CN) to account for the runoff reduction provided by a <i>vegetated filter strip</i> when calculating the extreme peak discharge (Q _{p100}) on a development site.
Vegetated Filter Strips, C/D Soils	"Credit": Reduce the runoff reduction volume (RR _v) conveyed through a <i>vegetated filter strip</i> located on C/D soils by 30%.	"Credit": Reduce the runoff reduction volume (RR _v) conveyed through a <i>vegetated filter strip</i> located on C/D soils by 30%.			
Grass Channels, A/B or Amended Soils	"Credit": Reduce the runoff reduction volume (RR _v) conveyed through a <i>grass channel</i> located on A/B or amended soils by 25%.	"Credit": Reduce the runoff reduction volume (RR _v) conveyed through a <i>grass channel</i> located on A/B or amended soils by 25%.	"Credit": Proportionally adjust the post-development runoff curve number (CN) to account for the runoff reduction provided by a <i>vegetated filter strip</i> when calculating the aquatic resource protection volume (ARP _v) on a development site.	"Credit": Proportionally adjust the post-development runoff curve number (CN) to account for the runoff reduction provided by a <i>vegetated filter strip</i> when calculating the overbank peak discharge (Q _{p25}) on a development site.	"Credit": Proportionally adjust the post-development runoff curve number (CN) to account for the runoff reduction provided by a <i>vegetated filter strip</i> when calculating the extreme peak discharge (Q _{p100}) on a development site.
Grass Channels, C/D Soils	"Credit": Reduce the runoff reduction volume (RR _v) conveyed through a <i>grass channel</i> located on C/D soils by 12.5%.	"Credit": Reduce the runoff reduction volume (RR _v) conveyed through a <i>grass channel</i> located on C/D soils by 12.5%.			
Simple Downspout Disconnection, A/B or Amended Soils	"Credit": Reduce the runoff reduction volume (RR _v) conveyed through a <i>simple downspout disconnection</i> located on A/B or amended soils by 60%.	"Credit": Reduce the runoff reduction volume (RR _v) conveyed through a <i>simple downspout disconnection</i> located on A/B or amended soils by 60%.	"Credit": Proportionally adjust the post-development runoff curve number (CN) to account for the runoff reduction provided by a <i>simple downspout disconnection</i> when calculating the aquatic resource protection volume (ARP _v) on a development site.	"Credit": Proportionally adjust the post-development runoff curve number (CN) to account for the runoff reduction provided by a <i>simple downspout disconnection</i> when calculating the overbank peak discharge (Q _{p25}) on a development site.	"Credit": Proportionally adjust the post-development runoff curve number (CN) to account for the runoff reduction provided by a <i>simple downspout disconnection</i> when calculating the extreme peak discharge (Q _{p100}) on a development site.
Simple Downspout Disconnection, C/D Soils	"Credit": Reduce the runoff reduction volume (RR _v) conveyed through a <i>simple downspout disconnection</i> located on C/D soils by 30%.	"Credit": Reduce the runoff reduction volume (RR _v) conveyed through a <i>simple downspout disconnection</i> located on C/D soils by 30%.			

Table 7.1: How Green Infrastructure Practices Can Be Used to Help Satisfy the Stormwater Management Criteria

Green Infrastructure Practice	Stormwater Runoff Reduction	Water Quality Protection	Aquatic Resource Protection	Overbank Flood Protection	Extreme Flood Protection
Rain Gardens	"Credit": Subtract 100% of the storage volume provided by a <i>rain garden</i> from the runoff reduction volume (RR _v) conveyed through the <i>rain garden</i> .	"Credit": Subtract 100% of the storage volume provided by a <i>rain garden</i> from the runoff reduction volume (RR _v) conveyed through the <i>rain garden</i> .	"Credit": Proportionally adjust the post-development runoff curve number (CN) to account for the runoff reduction provided by a <i>rain garden</i> when calculating the aquatic resource protection volume (ARP _v) on a development site.	"Credit": Proportionally adjust the post-development runoff curve number (CN) to account for the runoff reduction provided by a <i>rain garden</i> when calculating the overbank peak discharge (Q _{p25}) on a development site.	"Credit": Proportionally adjust the post-development runoff curve number (CN) to account for the runoff reduction provided by a <i>rain garden</i> when calculating the extreme peak discharge (Q _{p100}) on a development site.
Stormwater Planters	"Credit": Subtract 50% of the storage volume provided by a <i>stormwater planter</i> from the runoff reduction volume (RR _v) conveyed through the <i>stormwater planter</i> .	"Credit": Subtract 50% of the storage volume provided by a <i>stormwater planter</i> from the runoff reduction volume (RR _v) conveyed through the <i>stormwater planter</i> .	"Credit": Proportionally adjust the post-development runoff curve number (CN) to account for the runoff reduction provided by a <i>stormwater planter</i> when calculating the aquatic resource protection volume (ARP _v) on a development site.	"Credit": Proportionally adjust the post-development runoff curve number (CN) to account for the runoff reduction provided by a <i>stormwater planter</i> when calculating the overbank peak discharge (Q _{p25}) on a development site.	"Credit": Proportionally adjust the post-development runoff curve number (CN) to account for the runoff reduction provided by a <i>stormwater planter</i> when calculating the extreme peak discharge (Q _{p100}) on a development site.
Dry Wells	"Credit": Subtract 100% of the storage volume provided by a <i>dry well</i> from the runoff reduction volume (RR _v) conveyed through the <i>dry well</i> .	"Credit": Subtract 100% of the storage volume provided by a <i>dry well</i> from the runoff reduction volume (RR _v) conveyed through the <i>dry well</i> .	"Credit": Proportionally adjust the post-development runoff curve number (CN) to account for the runoff reduction provided by a <i>dry well</i> when calculating the aquatic resource protection volume (ARP _v) on a development site.	"Credit": Proportionally adjust the post-development runoff curve number (CN) to account for the runoff reduction provided by a <i>dry well</i> when calculating the overbank peak discharge (Q _{p25}) on a development site.	"Credit": Proportionally adjust the post-development runoff curve number (CN) to account for the runoff reduction provided by a <i>dry well</i> when calculating the extreme peak discharge (Q _{p100}) on a development site.
Rainwater Harvesting	"Credit": Subtract 75% of the storage volume provided by a <i>rainwater harvesting system</i> from the runoff reduction volume (RR _v) captured by the <i>system</i> .	"Credit": Subtract 75% of the storage volume provided by a <i>rainwater harvesting system</i> from the runoff reduction volume (RR _v) captured by the <i>system</i> .	"Credit": Proportionally adjust the post-development runoff curve number (CN) to account for the runoff reduction provided by a <i>rainwater harvesting system</i> when calculating the aquatic resource protection volume (ARP _v) on a development site.	"Credit": Proportionally adjust the post-development runoff curve number (CN) to account for the runoff reduction provided by a <i>rainwater harvesting system</i> when calculating the overbank peak discharge (Q _{p25}) on a development site.	"Credit": Proportionally adjust the post-development runoff curve number (CN) to account for the runoff reduction provided by a <i>rainwater harvesting system</i> when calculating the extreme peak discharge (Q _{p100}) on a development site.

Table 7.1: How Green Infrastructure Practices Can Be Used to Help Satisfy the Stormwater Management Criteria

Green Infrastructure Practice	Stormwater Runoff Reduction	Water Quality Protection	Aquatic Resource Protection	Overbank Flood Protection	Extreme Flood Protection
Bioretention Areas, No Underdrain	"Credit": Subtract 100% of the storage volume provided by a non-underdrained <i>bioretention area</i> from the runoff reduction volume (RR _v) conveyed through the <i>bioretention area</i> .	"Credit": Subtract 100% of the storage volume provided by a non-underdrained <i>bioretention area</i> from the runoff reduction volume (RR _v) conveyed through the <i>bioretention area</i> .	"Credit": Proportionally adjust the post-development runoff curve number (CN) to account for the runoff reduction provided by a <i>bioretention area</i> when calculating the aquatic resource protection volume (ARP _v) on a development site.	"Credit": Proportionally adjust the post-development runoff curve number (CN) to account for the runoff reduction provided by a <i>bioretention area</i> when calculating the overbank peak discharge (Q _{p25}) on a development site.	"Credit": Proportionally adjust the post-development runoff curve number (CN) to account for the runoff reduction provided by a <i>bioretention area</i> when calculating the extreme peak discharge (Q _{p100}) on a development site.
Bioretention Areas, Underdrain	"Credit": Subtract 50% of the storage volume provided by an underdrained <i>bioretention area</i> from the runoff reduction volume (RR _v) conveyed through the <i>bioretention area</i> .	"Credit": Subtract 50% of the storage volume provided by an underdrained <i>bioretention area</i> from the runoff reduction volume (RR _v) conveyed through the <i>bioretention area</i> .			
Infiltration Practices	"Credit": Subtract 100% of the storage volume provided by an <i>infiltration practice</i> from the runoff reduction volume (RR _v) conveyed through the <i>infiltration practice</i> .	"Credit": Subtract 100% of the storage volume provided by an <i>infiltration practice</i> from the runoff reduction volume (RR _v) conveyed through the <i>infiltration practice</i> .	"Credit": Proportionally adjust the post-development runoff curve number (CN) to account for the runoff reduction provided by an <i>infiltration practice</i> when calculating the aquatic resource protection volume (ARP _v) on a development site.	"Credit": Proportionally adjust the post-development runoff curve number (CN) to account for the runoff reduction provided by an <i>infiltration practice</i> when calculating the overbank peak discharge (Q _{p25}) on a development site.	"Credit": Proportionally adjust the post-development runoff curve number (CN) to account for the runoff reduction provided by an <i>infiltration practice</i> when calculating the extreme peak discharge (Q _{p100}) on a development site.
Dry Swales, No Underdrain	"Credit": Subtract 100% of the storage volume provided by a non-underdrained <i>dry swale</i> from the runoff reduction volume (RR _v) conveyed through the <i>dry swale</i> .	"Credit": Subtract 100% of the storage volume provided by a non-underdrained <i>dry swale</i> from the runoff reduction volume (RR _v) conveyed through the <i>dry swale</i> .	"Credit": Proportionally adjust the post-development runoff curve number (CN) to account for the runoff reduction provided by a <i>dry swale</i> when calculating the aquatic resource protection volume (ARP _v) on a development site.	"Credit": Proportionally adjust the post-development runoff curve number (CN) to account for the runoff reduction provided by a <i>dry swale</i> when calculating the overbank peak discharge (Q _{p25}) on a development site.	"Credit": Proportionally adjust the post-development runoff curve number (CN) to account for the runoff reduction provided by a <i>dry swale</i> when calculating the extreme peak discharge (Q _{p100}) on a development site.
Dry Swales, Underdrain	"Credit": Subtract 50% of the storage volume provided by an underdrained <i>dry swale</i> from the runoff reduction volume (RR _v) conveyed through the <i>dry swale</i> .	"Credit": Subtract 50% of the storage volume provided by an underdrained <i>dry swale</i> from the runoff reduction volume (RR _v) conveyed through the <i>dry swale</i> .			

7.5.2 Step 2: Evaluate Overall Feasibility

Through the use of the second screening matrix (Table 7.2), site planning and design teams can evaluate the overall feasibility of applying each of the green infrastructure practices on a development site. Additional information about each of the screening categories included in the matrix is provided below.

- Drainage Area: This column describes how large of a contributing drainage area each green infrastructure practice can realistically handle. It indicates the maximum size of the contributing drainage area that each green infrastructure practice should be designed to “receive” stormwater runoff from.
- Area Required: This column indicates how much space the green infrastructure practice typically consumes on a development site.
- Slope: This column describes the influence that site slope can have on the performance of the green infrastructure practice. It indicates the maximum or minimum slope on which the green infrastructure practice can be installed.
- Minimum Head: This column provides an estimate of the minimum amount of elevation difference needed within the green infrastructure practice, from the inflow to the outflow, to allow for gravity operation.
- Minimum Depth to Water Table: This column indicates the minimum distance that should be provided between the bottom of the green infrastructure practice and the top of the water table.
- Soils: This column describes the influence that the underlying soils (i.e., hydrologic soil groups) can have on the performance of the green infrastructure practice.

Table 7.2: Factors to Consider When Evaluating the Overall Feasibility of Green Infrastructure Practices

Green Infrastructure Practice	Drainage Area	Area Required	Slope	Minimum Head	Minimum Depth to Water Table	Soils
Better Site Planning Techniques						
Protect Primary Conservation Areas	N/A	10,000 SF minimum to receive stormwater management "credits"	No restrictions	N/A	N/A	No restrictions
Protect Secondary Conservation Areas	N/A	10,000 SF minimum to receive stormwater management "credits"	Protect slopes >15%	N/A	N/A	Protect erodible soils
Better Site Design Techniques						
Reduce Clearing and Grading Limits	N/A	No restrictions	No restrictions	N/A	N/A	No restrictions
Reduce Roadway Lengths and Widths	N/A	N/A	No restrictions	N/A	N/A	No restrictions
Use Fewer or Alternative Cul-de-Sacs	N/A	N/A	No restrictions	N/A	N/A	No restrictions
Reduce Parking Lot Footprints	N/A	N/A	No restrictions	N/A	N/A	No restrictions
Create Landscaping Areas in Parking Lots	N/A	N/A	No restrictions	N/A	N/A	No restrictions
Reduce Driveway Lengths and Widths	N/A	N/A	No restrictions	N/A	N/A	No restrictions
Reduce Sidewalk Lengths and Widths	N/A	N/A	No restrictions	N/A	N/A	No restrictions
Reduce Building Footprints	N/A	N/A	No restrictions	N/A	N/A	No restrictions
Reduce Setbacks and Frontages	N/A	N/A	No restrictions	N/A	N/A	No restrictions
Low Impact Development Practices						
Alternatives to Disturbed Pervious Surfaces						
Soil Restoration	N/A	No restrictions	10% maximum	N/A	1.5 FT	Restore hydrologic soil group C/D or disturbed soils
Site Reforestation/Revegetation	N/A	10,000 SF minimum to receive stormwater management "credits"	25% maximum	N/A	No restrictions	No restrictions

Table 7.2: Factors to Consider When Evaluating the Overall Feasibility of Green Infrastructure Practices

Green Infrastructure Practice	Drainage Area	Area Required	Slope	Minimum Head	Minimum Depth to Water Table	Soils
Alternatives to Impervious Surfaces						
Green Roofs	N/A	No restrictions	25% maximum, although 10% or less is recommended	6 to 12 inches	N/A	Use appropriate engineered growing media
Permeable Pavement	N/A	No restrictions	6%	2 to 4 feet	2 feet	Should drain within 48 hours of end of rainfall event
"Receiving" Low Impact Development Practices						
Undisturbed Pervious Areas	Length of flow path in contributing drainage area maximum 75 to 150 feet long	Length of flow path in undisturbed pervious area minimum 50 feet long	Maximum 3% in contributing drainage area; 0.5% to 6% in undisturbed pervious area	N/A	No restrictions	No restrictions
Vegetated Filter Strips	Length of flow path in contributing drainage area maximum 75 to 150 feet long	Length of flow path in vegetated filter strip minimum 15 to 25 feet long	Maximum 3% in contributing drainage area; 0.5% to 6% in vegetated filter strip	N/A	No restrictions	No restrictions
Grass Channels	5 acres	Bottom of grass channel 2 to 8 feet wide; side slopes of 3:1 or flatter	0.5% to 3%, although 1% to 2% is recommended	N/A	2 feet	No restrictions
Simple Downspout Disconnection	2,500 square feet; length of flow path in contributing drainage area maximum 75 feet long	Length of flow path at least 15 feet long and equal to or greater than that of contributing drainage area	0.5% to 6%, although 1% to 5% is recommended	N/A	No restrictions	No restrictions
Rain Gardens	2,500 square feet; length of flow path in contributing drainage area maximum 75 to 150 feet long	10-20% of contributing drainage area	6%	30 to 36 inches ¹	2 feet	Should drain within 24 hours of end of rainfall event
Stormwater Planters	2,500 square feet; length of flow path in contributing drainage area maximum 75 to 150 feet long	5% of contributing drainage area	6%	30 to 36 inches ¹	2 feet ¹	Should drain within 24 hours of end of rainfall event

Table 7.2: Factors to Consider When Evaluating the Overall Feasibility of Green Infrastructure Practices

Green Infrastructure Practice	Drainage Area	Area Required	Slope	Minimum Head	Minimum Depth to Water Table	Soils
Dry Wells	2,500 square feet; length of flow path in contributing drainage area maximum 75 to 150 feet long	5-10% of contributing drainage area	6%	2 feet ¹	2 feet	Should drain within 24 hours of end of rainfall event
Rainwater Harvesting	No restrictions	Varies according to the dimensions of the rain tank or cistern used to store the harvested rainwater	No restrictions	N/A	N/A	N/A
Bioretention Areas	5 acres	5-10% of contributing drainage area	6%	42 to 48 inches ¹	2 feet	Should drain within 48 hours of end of rainfall event
Infiltration Practices	2 to 5 acres	5% of contributing drainage area	6%	42 to 48 inches ¹	2 feet	Should drain within 48 hours of end of rainfall event
Dry Swales	5 acres	5-10% of contributing drainage area	0.5% to 4%, although 1% to 2% is recommended	36 to 48 inches ¹	2 feet	Should drain within 48 hours of end of rainfall event
Notes: 1 Criteria may be relaxed on development sites that have a shallow water table. See profile sheets provided in Sections 7.6-7.8 for additional information.						

7.5.3 Step 3: Evaluate Site Applicability

Through the use of the third screening matrix (Table 7.3), site planning and design teams can evaluate the applicability of each of the green infrastructure practices on a particular development site. Additional information about each of the screening categories included in the matrix is provided below.

- Rural Use: This column indicates whether or not the green infrastructure practice is suitable for use in rural areas and on low-density development sites.
- Suburban Use: This column indicates whether or not the green infrastructure practice is suitable for use in suburban areas and on medium-density development sites.
- Urban Use: This column identifies the green infrastructure practices that are suitable for use in urban and ultra-urban areas where space is at a premium.
- Construction Cost: This column assesses the relative construction cost of each of the green infrastructure practices.
- Maintenance: This column assesses the relative maintenance burden associated with each green infrastructure practice. It is important to note that nearly *all* green infrastructure practices require some kind of routine inspection and maintenance.

Table 7.3: Factors to Consider When Evaluating the Applicability of Green Infrastructure Practices on a Development Site					
Green Infrastructure Practice	Rural Use	Suburban Use	Urban Use	Construction Cost	Maintenance
Better Site Planning Techniques					
Protect Primary Conservation Areas	✓	✓	*	Low	Low
Protect Secondary Conservation Areas	✓	✓	*	Low	Low
Better Site Design Techniques					
Reduce Clearing and Grading Limits	✓	✓	✓	Low	Low
Reduce Roadway Lengths and Widths	✓	✓	*	None	None
Use Fewer or Alternative Cul-de-Sacs	✓	✓	*	None	None
Reduce Parking Lot Footprints	*	✓	✓	None	None
Create Landscaping Areas in Parking Lots	*	✓	✓	None	None
Reduce Driveway Lengths and Widths	✓	✓	*	None	None
Reduce Sidewalk Lengths and Widths	*	✓	✓	None	None
Reduce Building Footprints	*	✓	✓	None	None
Reduce Setbacks and Frontages	✓	✓	*	None	None
Low Impact Development Practices					
Alternatives to Disturbed Pervious Surfaces					
Soil Restoration	✓	✓	✓	Medium	Low
Site Reforestation/ Revegetation	✓	✓	*	Medium	Low
Alternatives to Impervious Surfaces					
Green Roofs	*	✓	✓	High	Low
Permeable Pavement	*	✓	✓	High	High
"Receiving" Low Impact Development Practices					
Undisturbed Pervious Areas	✓	✓		Low	Low
Vegetated Filter Strips	✓	✓	*	Low	Low
Grass Channels	✓	✓		Low	Medium

Table 7.3: Factors to Consider When Evaluating the Applicability of Green Infrastructure Practices on a Development Site					
Green Infrastructure Practice	Rural Use	Suburban Use	Urban Use	Construction Cost	Maintenance
Simple Downspout Disconnection	✓	✓	*	Low	Low
Rain Gardens	✓	✓	*	Low	Medium
Stormwater Planters		✓	✓	High	Medium
Dry Wells	✓	✓	✓	Medium	Medium
Rainwater Harvesting	✓	✓	✓	Medium	High
Bioretention Areas	✓	✓	✓	Medium	Medium
Infiltration Practices	✓	✓	✓	Medium	High
Dry Swales	✓	✓	*	Medium	Medium
Notes: ✓ = Suitable for use on development sites located in these areas. * = Under certain situations, can be used on development sites located in these areas.					

7.6 Better Site Planning Technique Profile Sheets

This Section contains profile sheets that provide information about the better site planning techniques that are *recommended* for use in coastal Georgia. The profile sheets describe each of the better site planning techniques and provide information about how they can be used to help satisfy the SWM Criteria presented in this CSS. The better site planning techniques profiled in this Section include:

Better Site Planning Techniques

- 7.6.1 Preserve Primary Conservation Areas
- 7.6.2 Preserve Secondary Conservation Areas

THIS PAGE INTENTIONALLY LEFT BLANK

7.6.1 Protect Primary Conservation Areas

Description

Primary conservation areas, which include, but are not limited to, perennial and intermittent streams, freshwater wetlands, tidal creeks, coastal marshlands, maritime forests, marsh hammocks, aquatic buffers and shellfish harvesting areas, should be protected, in perpetuity, from the direct impacts of the land development process.

<u>KEY CONSIDERATIONS</u>	<u>USING THIS TECHNIQUE</u>
<ul style="list-style-type: none"> • Protects important priority habitat areas from the direct impacts of the land development process • Helps maintain pre-development site hydrology by reducing post-construction stormwater runoff rates, volumes and pollutant loads • Preserves a site’s natural character and aesthetic features, which may increase the resale value of the development project • Conservation areas can be used to “receive” stormwater runoff generated elsewhere on the development site (Section 7.8.5) 	<ul style="list-style-type: none"> ☑ Complete natural resources inventory prior to initiating site planning and design process ☑ Ensure that primary conservation areas are maintained in an undisturbed, natural state before, during and after construction

Discussion

Protecting primary conservation areas such as perennial and intermittent streams, freshwater wetlands, tidal creeks, coastal marshlands (Figure 7.5), maritime forests, marsh hammocks, aquatic buffers and shellfish harvesting areas, helps preserve important habitat for coastal Georgia’s high priority plant and animal species (Appendix A) and helps maintain pre-development site hydrology by reducing post-construction stormwater runoff rates, volumes and pollutant loads. It also helps prevent soil erosion and provides areas that can be used to “receive” stormwater runoff generated elsewhere on the development site (Section 7.8.5).



Figure 7.5: Coastal Marshlands are Considered to be a Primary Conservation Area
(Source: Center for Watershed Protection)

The primary and secondary conservation areas found on a development site should be identified during the natural resources inventory (Section 6.3.3) and should be mapped at the very beginning of the site planning and design process (Figure 7.6). The identification and subsequent preservation and/or restoration of these natural resources helps reduce the negative impacts of the land development process “by design.”

In accordance with SP&D Criteria #2 (Section 4.3.2), it is *recommended* that the following primary conservation areas, which provide habitat for high priority plant and animal species (Appendix A) and are considered to be high priority habitat areas (WRD, 2005), be protected

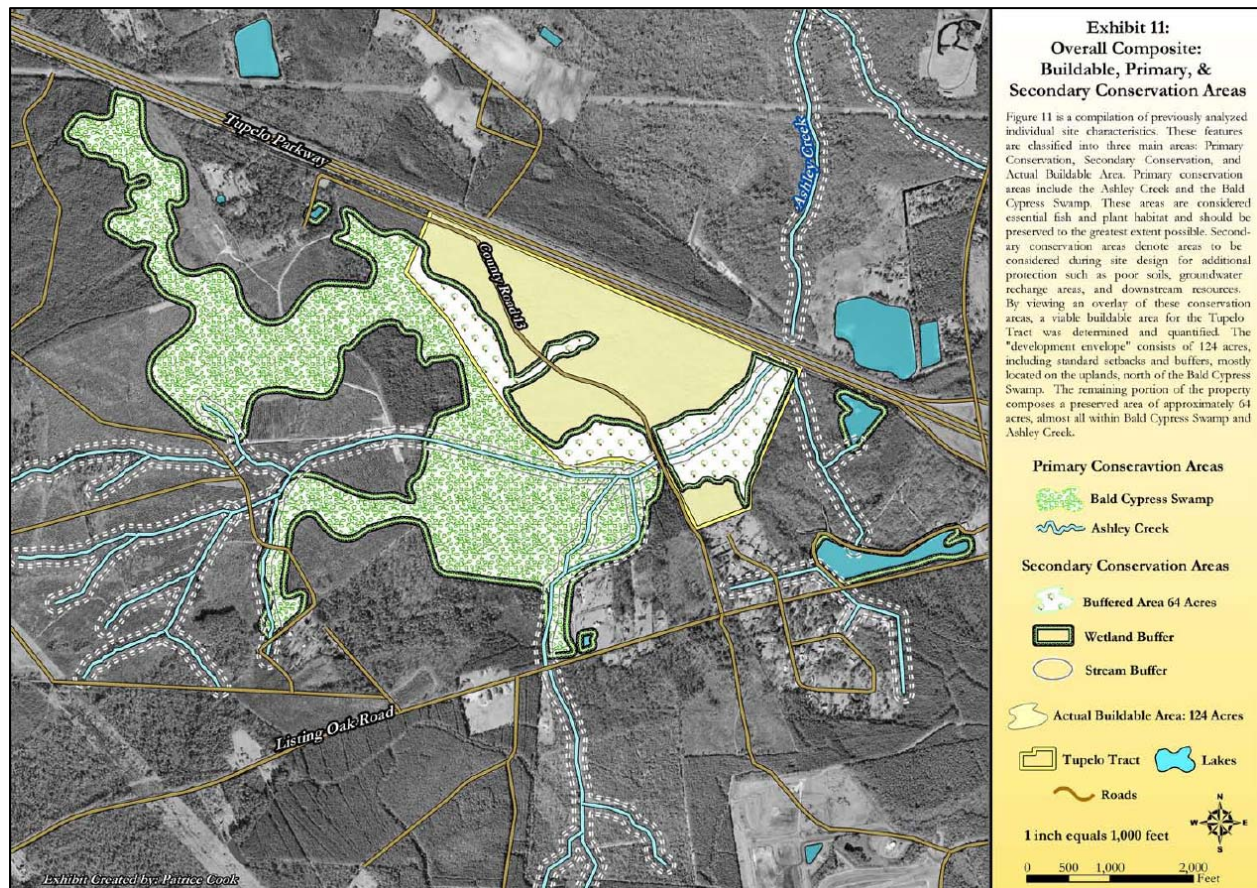

Figure 7.6: Primary and Secondary Conservation Areas Identified at the Beginning of the Site Planning and Design Process

(Source: Merrill et al., 2006)

from the direct impacts of the land development process:

- Aquatic Resources
 - Rivers
 - Perennial and Intermittent Streams
 - Freshwater Wetlands
 - Tidal Rivers and Streams
 - Tidal Creeks
 - Coastal Marshlands
 - Tidal Flats
 - Scrub-Shrub Wetlands
 - Near Coastal Waters
 - Beaches
- Terrestrial Resources
 - Dunes
 - Maritime Forests
 - Marsh Hammocks
 - Evergreen Hammocks
 - Canebrakes
 - Bottomland Hardwood Forests
 - Beech-Magnolia Forests

- Pine Flatwoods
- Longleaf Pine-Wiregrass Savannas
- Longleaf Pine-Scrub Oak Woodlands
- Other Resources
 - Aquatic Buffers
 - Shellfishing Areas
 - Other High Priority Habitat Areas

Additional information about all of these natural resources, including information about the ecological functions and values that they provide, can be found in Section 2.0.

Primary conservation areas that will be protected from the direct impacts of the land development process should be clearly identified on all development plans. They should be protected during construction, preferably with temporary construction fencing, and should be protected in perpetuity through a legally enforceable conservation instrument (e.g., conservation easement, deed restriction). Once established, primary conservation areas should be maintained in an undisturbed, natural state over time.

Stormwater Management “Credits”

Although protecting primary conservation areas can be thought of as a “self-crediting” stormwater management technique (i.e., protecting them *implicitly* reduces post-construction stormwater runoff rates, volumes and pollutant loads), it is important not to overlook the valuable stormwater management and other environmental benefits that this better site planning technique provides. Consequently, it has been assigned quantifiable stormwater management “credits” that can be used when determining the SWM Criteria that apply to a development site:

- Stormwater Runoff Reduction: Subtract any *primary conservation areas* from the total site area when calculating the runoff reduction volume (RR_v) that applies to a development site.
- Water Quality Protection: Subtract any *primary conservation areas* from the total site area when calculating the runoff reduction volume (RR_v) that applies to a development site.
- Aquatic Resource Protection: Assume that the post-development hydrologic conditions of any *primary conservation areas* are equivalent to the pre-development hydrologic conditions for those same areas.
- Overbank Flood Protection: Assume that the post-development hydrologic conditions of any *primary conservation areas* are equivalent to the pre-development hydrologic conditions for those same areas.
- Extreme Flood Protection: Assume that the post-development hydrologic conditions of any *primary conservation areas* are equivalent to the pre-development hydrologic conditions for those same areas.

In order to be eligible for these “credits,” it is *recommended* that primary conservation areas satisfy the planning and design criteria outlined below.

Planning and Design Criteria

It is *recommended* that primary conservation areas meet all of the following criteria to be eligible for the stormwater management “credits” described above:

General Planning and Design Criteria

- Primary conservation areas should have a contiguous area of 10,000 square feet or more.
- Primary conservation areas should not be disturbed before, during or after construction (except for temporary disturbances associated with incidental utility construction, restoration activities or removal of invasive vegetation).
- Primary conservation areas should be clearly identified on all development plans. Limits of disturbance around all primary conservation areas should be clearly marked on all development plans and should be delineated with temporary fencing prior to the start of any land disturbing activities.
- Primary conservation areas should be protected, in perpetuity, from the direct impacts of the land development process by a legally enforceable conservation instrument (e.g., conservation easement, deed restriction).
- A long-term vegetation management plan should be developed for all primary conservation areas. The plan should clearly specify how the area will be maintained in an undisturbed, natural state over time. Turf management is *not* considered to be an acceptable form of vegetation management. Consequently, only primary conservation areas that remain in an undisturbed, natural state are eligible for this “credit” (i.e., primary conservation areas consisting of managed turf are *not* eligible for this “credit”).

7.6.2 Protect Secondary Conservation Areas

Description

Secondary conservation areas, which include, but are not limited to, natural drainage features, trees and other existing vegetation and groundwater recharge areas, should be protected, in perpetuity, from the direct impacts of the land development process.

<u>KEY CONSIDERATIONS</u>	<u>USING THIS TECHNIQUE</u>
<ul style="list-style-type: none"> • Protects important natural resources from the direct impacts of the land development process • Helps maintain pre-development site hydrology by reducing post-construction stormwater runoff rates, volumes and pollutant loads • Preserves a site’s natural character and aesthetic features, which may increase the resale value of the development project • Conservation areas can be used to “receive” stormwater runoff generated elsewhere on the development site (Section 7.8.5) 	<ul style="list-style-type: none"> ☑ Complete natural resources inventory prior to initiating the site planning and design process ☑ Ensure that secondary conservation areas are maintained in an undisturbed, natural state before, during and after construction

Discussion

Protecting secondary conservation areas, such as natural drainage features, trees and other existing vegetation (Figure 7.7) and groundwater recharge areas, helps maintain pre-development site hydrology by reducing post-construction stormwater runoff rates, volumes and pollutant loads. It also helps prevent soil erosion and provides areas that can be used to “receive” stormwater runoff generated elsewhere on the development site (Section 7.8.5).

The primary and secondary conservation areas found on a development site should be identified during the natural resources inventory (Section 6.3.3) and should be mapped at the very beginning of the site planning and design process (Figure 7.6). The identification and subsequent preservation and/or restoration of these natural resources helps reduce the negative impacts of the land development process “by design.”

In accordance with SP&D Criteria #2 (Section 4.3.2), it is *recommended* that consideration be given to protecting the following secondary conservation areas from the direct impacts of the land development process:

- General Resources
 - Natural Drainage Features (e.g., Swales, Basins, Depressional Areas)



Figure 7.7: Conservation Area in Midway, GA

(Source: Merrill et al., 2006)

- Erodible Soils
- Steep Slopes (i.e., Areas with Slopes Greater Than 15%)
- Trees and Other Existing Vegetation
- Aquatic Resources
 - Groundwater Recharge Areas
 - Wellhead Protection Areas
- Other Resources
 - Floodplains

Additional information about these natural resources, including information about the ecological functions and values that they provide, can be found in Section 2.0.

Secondary conservation areas that will be protected from the direct impacts of the land development process should be clearly identified on all development plans. They should be protected during construction, preferably with temporary construction fencing, and should be protected in perpetuity through a legally-enforceable conservation instrument (e.g., conservation easement, deed restriction). Once established, secondary conservation areas should be maintained in an undisturbed, natural state over time.

Stormwater Management “Credits”

Although protecting secondary conservation areas can be thought of as a “self-crediting” stormwater management technique (i.e., protecting them *implicitly* reduces post-construction stormwater runoff rates, volumes and pollutant loads), it is important not to overlook the valuable stormwater management benefits that this better site planning technique provides. Consequently, it has been assigned quantifiable stormwater management “credits” that can be used when calculating the SWM Criteria that apply to a development site:

- Stormwater Runoff Reduction: Subtract any *secondary conservation areas* from the total site area when calculating the runoff reduction volume (RR_v) that applies to a development site.
- Water Quality Protection: Subtract any *secondary conservation areas* from the total site area when calculating the runoff reduction volume (RR_v) that applies to a development site.
- Aquatic Resource Protection: Assume that the post-development hydrologic conditions of any *secondary conservation areas* are equivalent to the pre-development hydrologic conditions for those same areas.
- Overbank Flood Protection: Assume that the post-development hydrologic conditions of any *secondary conservation areas* are equivalent to the pre-development hydrologic conditions for those same areas.
- Extreme Flood Protection: Assume that the post-development hydrologic conditions of any *secondary conservation areas* are equivalent to the pre-development hydrologic conditions for those same areas.

In order to be eligible for these “credits,” it is *recommended* that secondary conservation areas satisfy the planning and design criteria outlined below.

Planning and Design Criteria

It is *recommended* that secondary conservation areas meet all of the following criteria to be eligible for the stormwater management “credits” described above:

General Planning and Design Criteria

- Secondary conservation areas should have a contiguous area of 10,000 square feet or more.
- Secondary conservation areas should not be disturbed before, during or after construction (except for temporary disturbances associated with incidental utility construction, restoration activities or removal of invasive vegetation).
- Secondary conservation areas should be clearly identified on all development plans. Limits of disturbance around all primary conservation areas should be clearly marked on all development plans and should be delineated with temporary fencing prior to the start of land disturbing activities.
- Secondary conservation areas should be protected, in perpetuity, from the direct impacts of the land development process by a legally-enforceable conservation instrument (e.g., conservation easement, deed restriction).
- A long-term vegetation management plan should be developed for all secondary conservation areas. The plan should clearly specify how the area will be maintained in an undisturbed, natural state over time.

THIS PAGE INTENTIONALLY LEFT BLANK

7.7 Better Site Design Technique Profile Sheets

This Section contains profile sheets that provide information about the better site design techniques that are *recommended* for use in coastal Georgia. The profile sheets describe each of the better site design techniques, discuss how to apply them to development sites and provide information about how they can be used to help satisfy the SWM Criteria presented in this CSS. The better site design techniques profiled in this Section include:

Better Site Design Techniques

- 7.7.1 Reduce Clearing and Grading Limits
- 7.7.2 Reduce Roadway Lengths and Widths
- 7.7.3 Use Fewer or Alternative Cul-de-Sacs
- 7.7.4 Reduce Parking Lot Footprints
- 7.7.5 Create Landscaping Areas in Parking Lots
- 7.7.6 Reduce Driveway Lengths and Widths
- 7.7.7 Reduce Sidewalk Length and Widths
- 7.7.8 Reduce Building Footprints
- 7.7.9 Reduce Setbacks and Frontages

It is important to note that, although all of the better site design techniques listed above are *recommended* for use in coastal Georgia, their use may be restricted by local codes and ordinances. Many communities across the country have found that their own local “development rules” (e.g., subdivision ordinances, zoning ordinances, parking lot and street design standards) have prevented these better site design techniques from being applied during the site planning and design process (CWP, 1998). These communities have found that their own codes and ordinances are responsible for the wide streets, expansive parking lots and large lot subdivisions that are crowding out the very natural resources that they are trying to protect.

Obviously, it is difficult to make use of the recommended better site design techniques listed above when local “development rules” restrict their use. Although the Center for Watershed Protection (CWP, 1998) has developed a process that can be used to review and revise these “development rules,” it often takes some time to work through this process. Therefore, until these revisions have been completed and all of the barriers to the use of better site design techniques have been removed, site planning and design teams are encouraged to consult with the local development review authority to identify any local restrictions on the use of the better site design techniques discussed in this CSS.

NOTE: Much of the information presented in the following profile sheets can also be found in Section 1.4 of Volume 2 of the *Georgia Stormwater Management Manual* (ARC, 2001). It has been updated with information about the stormwater management “credits” associated with each of these better site design techniques and is presented here to prevent the reader from having to leave the CSS during the site planning and design process.

THIS PAGE INTENTIONALLY LEFT BLANK

7.7.1 Reduce Clearing and Grading Limits

Description

Reduced clearing and grading limits should be used to help minimize the creation of new disturbed pervious cover on development sites.

<u>KEY CONSIDERATIONS</u>	<u>USING THIS TECHNIQUE</u>
<ul style="list-style-type: none"> • Helps minimize the creation of new disturbed pervious cover on development sites • Helps maintain pre-development site hydrology by reducing post-construction stormwater runoff rates, volumes and pollutant loads • Helps protect important aquatic and terrestrial resources from the direct impacts of the land development process • Preserves a site’s natural character and aesthetic features, which may increase the resale value of the development project 	<ul style="list-style-type: none"> ☑ Establish limits of disturbance for all land disturbing activities ☑ Minimize clearing and grading and land disturbance to preserve natural resources and pre-development site hydrology

Discussion

After construction, cleared and graded areas are typically seeded with turf and turned into lawns, parks and other managed open spaces. At one time, these disturbed pervious areas were thought to provide significant stormwater management benefits. However, recent research has shown that clearing, grading and other land disturbing activities can significantly reduce the ability of disturbed pervious areas to reduce post-construction stormwater runoff rates, volumes and pollutant loads on development sites (Law et al., 2009, Schueler, 2000). Unless efforts are made to restore them to their pre-development conditions (Sections 7.8.1-7.8.2), these disturbed pervious areas provide few of the environmental benefits (e.g., stormwater runoff reduction, wildlife habitat, urban heat island mitigation) that comparable undisturbed pervious areas provide.

Consequently, site planning and design teams should strive to limit the amount of clearing and

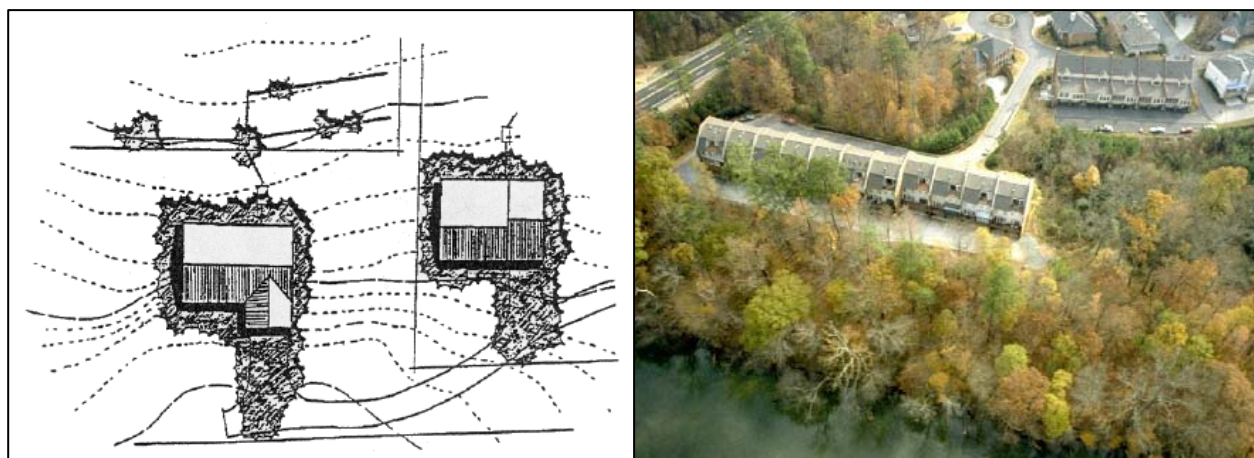

Figure 7.8: Reduced Clearing and Grading Limits Used on a Development Site

(Source: Atlanta Regional Commission, 2001)

grading that takes place on a development site (Figure 7.8). Doing so will help preserve pre-development site hydrology and reduce post-construction stormwater runoff rates, volumes and pollutant loads.

Methods that site planning and design teams can use to reduce clearing and grading limits on a development site include:

- Protecting primary and secondary conservation areas (Section 7.6)
- Preserving smaller undisturbed natural areas, including stands of trees and other vegetation
- Using construction equipment and techniques that will help reduce land disturbance
- Delineating, on all development plans, the smallest possible area that requires clearing and grading on the development site; all delineated limits of disturbance should reflect the needs of the construction equipment and techniques that will be used on the development site

Stormwater Management “Credits”

Although reducing clearing and grading can be thought of as a “self-crediting” stormwater management technique (i.e., it *implicitly* reduces post-construction stormwater runoff rates, volumes and pollutant loads), it is important not to overlook the valuable stormwater management benefits that this better site design technique provides. Consequently, it has been assigned quantifiable stormwater management “credits” that can be used when calculating the SWM Criteria that apply to a development site:

- Stormwater Runoff Reduction: Subtract 50% of any *undisturbed pervious areas* from the total site area when calculating the runoff reduction volume (RR_v) that applies to a development site.
- Water Quality Protection: Subtract 50% of any *undisturbed pervious areas* from the total site area when calculating the runoff reduction volume (RR_v) that applies to a development site.
- Aquatic Resource Protection: Assume that the post-development hydrologic conditions of any *undisturbed pervious areas* are equivalent to the pre-development hydrologic conditions for those same areas.
- Overbank Flood Protection: Assume that the post-development hydrologic conditions of any *undisturbed pervious areas* are equivalent to the pre-development hydrologic conditions for those same areas.
- Extreme Flood Protection: Assume that the post-development hydrologic conditions of any *undisturbed pervious areas* are equivalent to the pre-development hydrologic conditions for those same areas.

In order to be eligible for these “credits,” it is *recommended* that undisturbed pervious areas satisfy the planning and design criteria outlined below.

Planning and Design Criteria

It is *recommended* that undisturbed pervious areas meet all of the following criteria to be eligible for the stormwater management “credits” described above:

General Planning and Design Criteria

- Undisturbed pervious areas should not be disturbed before, during or after construction (except for temporary disturbances associated with incidental utility construction, restoration activities or removal of invasive vegetation).
- Undisturbed pervious areas should be clearly identified on all development plans. Limits of disturbance around all undisturbed pervious areas should be clearly marked on all development plans and should be delineated with temporary fencing prior to the start of land disturbing activities.
- A long-term vegetation management plan should be developed for all undisturbed pervious areas. The plan should clearly specify how the area will be maintained in an undisturbed, natural state over time. Turf management is *not* considered to be an acceptable form of vegetation management. Consequently, only pervious areas that remain in an undisturbed, natural state are eligible for this "credit" (i.e., pervious areas consisting of managed turf are *not* eligible for this "credit").

THIS PAGE INTENTIONALLY LEFT BLANK

7.7.2 Reduce Roadway Lengths and Widths

Description

Reduced roadway lengths and widths should be used to help reduce the creation of new impervious cover on development sites.

<u>KEY CONSIDERATIONS</u>	<u>USING THIS TECHNIQUE</u>
<ul style="list-style-type: none"> • Helps minimize the creation of new impervious cover on development sites • Helps maintain pre-development site hydrology by reducing post-construction stormwater runoff rates, volumes and pollutant loads • Reduces costs associated with roadway construction and maintenance 	<ul style="list-style-type: none"> ☑ Consider alternative site designs that reduce overall street length ☑ Minimize roadway width by using narrower street designs

Discussion

Reduced roadway lengths and widths (Figure 7.9) can be used to help minimize the creation of new impervious cover and reduce post-construction stormwater runoff rates, volumes and pollutant loads on development sites. Consequently, site planning and design teams are encouraged to minimize roadway lengths and widths on a development site.

Since there is no single site design technique that is guaranteed to minimize street length on a development site, site planning and design teams are encouraged to consider alternative site layouts to see how much total roadway pavement they require. Generally, compact site designs that make use of smaller lot sizes and reduced setbacks and frontages (Section 7.7.9) help reduce overall street lengths on development sites.



Figure 7.9: Reduced Street Width Used on a Residential Development Site
(Source: Center for Watershed Protection)

Consequently, site planning and design teams are encouraged to create site designs that include a large number of small lots located off of a few main roadways, rather than a small number of large lots located off of a complex network of local roads.

In addition to minimizing street length on development sites, site planning and design teams are also encouraged to reduce street widths to the minimum needed to support travel, on-street parking and emergency, maintenance and service vehicle access. Figure 7.10 shows some potential design options for roadways with reduced widths. Many times, on-street parking can be reduced to one lane or eliminated altogether on local cul-de-sac and two-way loop roads. Designing one-way single-lane loop roads is another effective way to reduce the width of local roadways that will see lower average daily traffic volumes.

If roadway lengths and widths cannot be minimized on a development site, site planning and design teams are encouraged to consider using grass channels (Section 7.8.7) or swales (Section

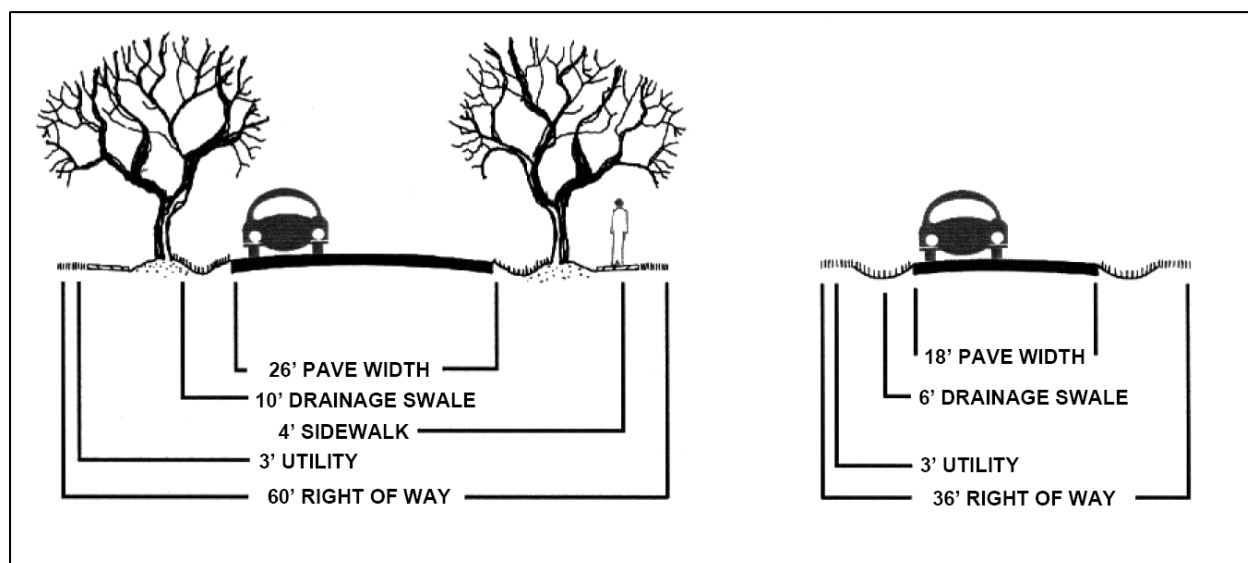

Figure 7.10: Potential Design Options for Reduced Roadway Widths

(Source: Atlanta Regional Commission, 2001)

8.6.6) to “receive” roadway runoff. In these situations, site planning and design teams may also want to consider the use of alternative paving surfaces, such as pervious concrete and permeable pavers, for roadway construction. Although permeable pavement is generally more expensive to install than conventional pavement (e.g., asphalt, concrete), it can provide measurable reductions in post-construction stormwater runoff rates, volumes and pollutant loads, which can reduce the need for larger and more costly stormwater management practices, such as wet ponds and stormwater wetlands, on a development site. For additional information about the use of permeable pavement on development sites, see Section 7.8.4.

Stormwater Management “Credits”

Reducing roadway lengths and widths on a development site can be thought of as a “self-crediting” stormwater management technique. Consequently, it has not been assigned any additional stormwater management “credits” beyond the implicit “credits” outlined below:

- Stormwater Runoff Reduction: “Self-crediting,” in that minimizing the creation of new impervious cover results in a lower volumetric runoff coefficient (R_v) and, consequently, a lower runoff reduction volume (RR_v) on a development site.
- Water Quality Protection: “Self-crediting,” in that minimizing the creation of new impervious cover results in a lower volumetric runoff coefficient (R_v) and, consequently, a lower runoff reduction volume (RR_v) on a development site.
- Aquatic Resource Protection: “Self-crediting,” in that minimizing the creation of new impervious cover results in a lower curve number (CN) and, consequently, a lower aquatic resource protection volume (ARP_v) on a development site.
- Overbank Flood Protection: “Self-crediting,” in that minimizing the creation of new impervious cover results in a lower curve number (CN) and, consequently, a lower overbank peak discharge (Q_{p25}) on a development site.

- Extreme Flood Protection: "Self-crediting," in that minimizing the creation of new impervious cover results in a lower curve number (CN) and, consequently, a lower extreme peak discharge (Q_{p100}) on a development site.

THIS PAGE INTENTIONALLY LEFT BLANK

7.7.3 Use Fewer or Alternative Cul-de-Sacs

Description

Fewer or alternative cul-de-sacs should be used to help minimize the amount of new impervious cover created on development sites. The dimensions of cul-de-sacs and alternative turnarounds should be reduced to the minimum needed to accommodate emergency, maintenance and service vehicles.

<u>KEY CONSIDERATIONS</u>	<u>USING THIS TECHNIQUE</u>
<ul style="list-style-type: none"> • Helps minimize the creation of new impervious cover on development sites • Helps maintain pre-development site hydrology by reducing post-construction stormwater runoff rates, volumes and pollutant loads • May provide pervious areas that can be used to “receive” stormwater runoff generated elsewhere on the development site 	<ul style="list-style-type: none"> ☑ Reduce cul-de-sac dimensions ☑ Consider alternative cul-de-sac designs and cul-de-sacs that include landscaping islands

Discussion

A cul-de-sac is a type of turnaround commonly used on dead-end streets on residential, commercial and industrial development sites (Figure 7.11). Many cul-de-sacs have radii of 40 feet or more, which means that they are responsible for a significant amount of the impervious cover found on a development site. Consequently, site planning and design teams are encouraged to use fewer or alternative cul-de-sacs on development sites to help minimize the creation of new impervious cover and reduce post-construction stormwater runoff rates, volumes and pollutant loads.



Figure 7.11: Cul-de-Sac on a Residential Development Site
(Source: Center for Watershed Protection)

Alternative cul-de-sac designs include cul-de-sacs with landscaping islands, cul-de-sacs with 30-foot radii, hammerheads and loop roads (Figure 7.12). Landscaping islands located within cul-de-sacs can be used to “receive” stormwater runoff generated elsewhere on the development site, and make ideal locations for bioretention areas (Section 7.8.13) and other low impact development practices. As shown in Table 7.4, each of the alternative cul-de-sac designs creates significantly less impervious cover than the traditional 40-foot cul-de-sac design.

Providing sufficient turnaround area is an important factor to consider during the design of cul-de-sacs and dead-end streets. In particular, the types of vehicles, such as fire trucks, service vehicles and school buses, that will have to enter the cul-de-sac should be considered. Although these vehicles are thought to have very large turning radii, some newer fire trucks have been designed with relatively small turning radii, and many newer service vehicles have been designed with tri-axles, which allows them to make tighter turns. Although school bus access is a

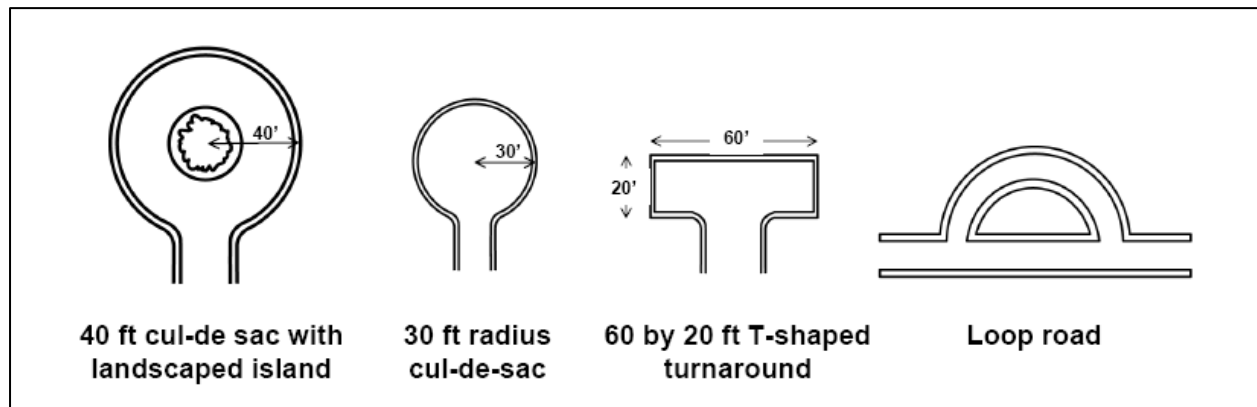

Figure 7.12: Alternative Cul-de-Sac Designs

(Source: Center for Watershed Protection, 1998)

Table 7.4: Impervious Cover Created by Various Turnaround Options
(Source: CWP, 1998, Schueler, 1995)

Turnaround Option	Impervious Cover (SF)
40 ft radius cul-de-sac	5,024
40 ft radius cul-de-sac with landscaped island	4,397
30 ft radius cul-de-sac	2,826
30 ft radius cul-de-sac with landscaped island	2,512
60 ft by 20 ft T-shaped turnaround	1,250

concern, many school bus drivers choose not to enter individual cul-de-sacs and instead choose to stay on the main roadways that pass through residential developments, which altogether alleviates any concerns over school bus access.

Stormwater Management "Credits"

Using fewer or alternative cul-de-sacs on a development site can be thought of as a "self-crediting" stormwater management technique. Consequently, it has not been assigned any additional stormwater management "credits" beyond the implicit "credits" outlined below:

- **Stormwater Runoff Reduction:** "Self-crediting," in that minimizing the creation of new impervious cover results in a lower volumetric runoff coefficient (R_v) and, consequently, a lower runoff reduction volume (RR_v) on a development site.
- **Water Quality Protection:** "Self-crediting," in that minimizing the creation of new impervious cover results in a lower volumetric runoff coefficient (R_v) and, consequently, a lower runoff reduction volume (RR_v) on a development site.
- **Aquatic Resource Protection:** "Self-crediting," in that minimizing the creation of new impervious cover results in a lower curve number (CN) and, consequently, a lower aquatic resource protection volume (ARP_v) on a development site.
- **Overbank Flood Protection:** "Self-crediting," in that minimizing the creation of new impervious cover results in a lower curve number (CN) and, consequently, a lower overbank peak discharge (Q_{p25}) on a development site.

- Extreme Flood Protection: "Self-crediting," in that minimizing the creation of new impervious cover results in a lower curve number (CN) and, consequently, a lower extreme peak discharge (Q_{p100}) on a development site.

THIS PAGE INTENTIONALLY LEFT BLANK

7.7.4 Reduce Parking Lot Footprints

Description

Consider reducing the amount of new impervious cover created on development sites by providing compact car spaces, minimizing stall dimensions, incorporating efficient parking lanes, using structured parking facilities and using alternative paving surfaces (e.g., permeable pavement) in parking lots.

<u>KEY CONSIDERATIONS</u>	<u>USING THIS TECHNIQUE</u>
<ul style="list-style-type: none"> • Helps minimize the creation of new impervious cover on development sites • Helps maintain pre-development site hydrology by reducing post-construction stormwater runoff rates, volumes and pollutant loads 	<ul style="list-style-type: none"> ☑ Consider alternative parking lot designs that reduce overall site imperviousness ☑ Consider the use of alternative paving surfaces

Discussion

Parking lots (Figure 7.13) are typically responsible for a significant amount of the impervious cover found on commercial and industrial development sites (CWP, 1998). Consequently, site planning and design teams are encouraged to reduce parking lot footprints to help minimize the creation of new impervious cover and reduce post-construction stormwater runoff rates, volumes and pollutant loads.



Figure 7.13: Parking Lot on a Commercial Development Site
(Source: Center for Watershed Protection)

Techniques that can be used to reduce parking lot footprints on development sites include:

- Rethinking parking lot design
- Minimizing parking stall dimensions
- Providing compact car parking spaces
- Using structured parking
- Using shared parking
- Using alternative paving surfaces (e.g., permeable pavement)

Each of these techniques is briefly described below.

Rethinking Parking Lot Design

Parking lots are often designed to provide far more parking spaces than are actually needed on a daily basis. This problem is exacerbated by the common practice of designing parking lots to provide enough parking spaces to accommodate the highest parking demand experienced during the peak shopping season. By using average parking demand as a basis for parking lot design, instead of peak parking demand, fewer parking spaces (which will still accommodate the parking demand for almost the entire year) and less impervious cover will be created on development sites. Table 7.5 provides examples of the conventional parking requirements

associated with different land uses and compares them to the actual average parking demand experienced on these same land uses.

Table 7.5: Conventional Minimum Parking Ratios
(Source: CWP, 1998)

Land Use	Parking Requirement		Actual Average Parking Demand
	Parking Ratio	Typical Range	
Single Family Homes	2 spaces per dwelling unit	1.5 - 2.5	1.11 spaces per dwelling unit
Shopping Center	5 spaces per 1,000 SF GFA ¹	4.0 - 6.5	3.97 per 1,000 SF GFA
Convenience Store	3 spaces per 1,000 SF GFA	2.0 - 10.0	--
Industrial	3.3 spaces per 1,000 SF GFA	0.5 - 2.0	1.48 per 1,000 SF GFA
Medical Office	1 space per 1,000 SF GFA	4.5 - 10.0	4.11 per 1,000 SF GFA

Notes:
1) GFA = gross floor area of a building, not including storage and utility spaces.

Minimizing Parking Stall Dimensions

Another technique that can be used to reduce parking lot footprints is to minimize the dimensions of parking spaces. This can be accomplished by reducing both the length and width of parking stalls by 6 to 12 inches on a development site. While the trend toward larger sport utility vehicles (SUVs) is often cited as a barrier to implementing these stall minimization techniques, the stall width requirements currently contained in most existing parking codes are large enough to accommodate even the widest of SUVs. Parking lot footprints can be even further reduced if compact car parking spaces are provided within parking lots.

Using Structured Parking

Structured parking decks are another technique that can be used to reduce parking lot footprints on a development site. Although costly, parking decks can be used to replace traditional surface parking lots, which frees up additional land for additional living, shopping or office space. Figure 7.14 shows a parking deck used on an office park development site.



Figure 7.14: Structured Parking Deck on an Office Park Development Site
(Source: Atlanta Regional Commission, 2001)

Using Shared Parking

Shared parking is another technique that can be used to reduce parking lot footprints on a development site. A shared parking arrangement might include usage of the same parking lot by an office building that experiences peak parking demand during weekdays with a church that experiences peak parking demands during weekends and evenings.

Using Alternative Paving Surfaces

If parking lot footprints cannot be minimized using any of the techniques described above, site planning and design teams should consider the use of alternative paving surfaces, such as pervious concrete and permeable pavers (Figure 7.15), for parking lot construction. Permeable

pavements can be used to reduce the amount of “effective” impervious cover found on a development site, since they allow stormwater runoff to pass through the surface course (i.e., pavement surface) into an underlying stone reservoir, where it is temporarily stored and allowed to infiltrate into the surrounding soils or conveyed back into the storm drain system using an underdrain system. Although permeable pavement is generally more expensive to install than conventional pavement (e.g., asphalt, concrete), it can provide measurable reductions in post-construction stormwater runoff rates, volumes and pollutant loads, which can reduce the need for larger and more costly stormwater management practices, such as wet ponds and stormwater wetlands, on a development site. For additional information about the use of permeable pavement on development sites, see Section 7.8.4.



**Figure 7.15: Permeable Pavers
Used in a Parking Lot**

(Source: Atlanta Regional Commission, 2001)

For additional information about the use of permeable pavement on development sites, see Section 7.8.4.

Stormwater Management “Credits”

Reducing parking lot footprints on a development site can be thought of as a “self-crediting” stormwater management technique. Consequently, it has not been assigned any additional stormwater management “credits” beyond the implicit “credits” outlined below:

- Stormwater Runoff Reduction: “Self-crediting,” in that minimizing the creation of new impervious cover results in a lower volumetric runoff coefficient (R_v) and, consequently, a lower runoff reduction volume (RR_v) on a development site.
- Water Quality Protection: “Self-crediting,” in that minimizing the creation of new impervious cover results in a lower volumetric runoff coefficient (R_v) and, consequently, a lower runoff reduction volume (RR_v) on a development site.
- Aquatic Resource Protection: “Self-crediting,” in that minimizing the creation of new impervious cover results in a lower curve number (CN) and, consequently, a lower aquatic resource protection volume (ARP_v) on a development site.
- Overbank Flood Protection: “Self-crediting,” in that minimizing the creation of new impervious cover results in a lower curve number (CN) and, consequently, a lower overbank peak discharge (Q_{p25}) on a development site.
- Extreme Flood Protection: “Self-crediting,” in that minimizing the creation of new impervious cover results in a lower curve number (CN) and, consequently, a lower extreme peak discharge (Q_{p100}) on a development site.

THIS PAGE INTENTIONALLY LEFT BLANK

7.7.5 Create Landscaping Areas in Parking Lots

Description

Consider reducing the amount of new impervious cover created on development sites by distributing landscaping areas, such as landscaping islands and buffer strips, throughout parking lots. In many cases, these landscaping areas can be designed to function as low impact development practices, such as vegetated filter strips (Section 7.8.6) and bioretention areas (Section 7.8.13), that can be used to “receive” stormwater runoff from other parts of the development site.

<u>KEY CONSIDERATIONS</u>	<u>USING THIS TECHNIQUE</u>
<ul style="list-style-type: none"> • Helps minimize the creation of new impervious cover on development sites • Helps maintain pre-development site hydrology by reducing post-construction stormwater runoff rates, volumes and pollutant loads • Trees and shrubs planted in landscaping areas provide shade for parked cars and improve parking lot aesthetics • Landscaping areas can be used to “receive” stormwater runoff generated elsewhere on the development site 	<ul style="list-style-type: none"> ☑ Consider alternative parking lot designs that include landscaped areas, such as landscaping islands and buffer strips ☑ Use landscaping areas to “receive” stormwater runoff generated elsewhere on the development site

Discussion

Site planning and design teams are encouraged to design parking lots with numerous landscaping areas, such as islands (Figure 7.16) and buffer strips, to help reduce the amount of new impervious cover created on development sites. In many cases, these landscaping areas can be designed to function as low impact development practices, such as vegetated filter strips (Section 7.8.6), bioretention areas (Section 7.8.13) and dry swales (Section 7.8.15), that can be used to “receive” stormwater runoff from other parts of the development site. Whenever practical, landscaping islands and buffer strips should be planted with shade trees and shrubs.



Figure 7.16: Landscaping Island Located Within a Parking Lot

(Source: Atlanta Regional Commission, 2001)

During the site planning and design process, it is important for site planning and design teams to keep in mind that a small number of large landscaping areas will sustain healthier vegetation than a large number of very small ones. One of the most effective ways to design landscaping areas that will support healthy plant communities is to use landscaping areas that are at least 6 feet wide and are filled with relatively porous soils that contain enough organic matter and nutrients to support plant growth (Cappiella et al., 2006a).

Stormwater Management “Credits”

Creating landscaping areas in parking lots can be thought of as a “self-crediting” stormwater management technique. Consequently, it has not been assigned any additional stormwater management “credits” beyond the implicit “credits” outlined below:

- Stormwater Runoff Reduction: “Self-crediting,” in that minimizing the creation of new impervious cover results in a lower volumetric runoff coefficient (R_v) and, consequently, a lower runoff reduction volume (RR_v) on a development site.
- Water Quality Protection: “Self-crediting,” in that minimizing the creation of new impervious cover results in a lower volumetric runoff coefficient (R_v) and, consequently, a lower runoff reduction volume (RR_v) on a development site.
- Aquatic Resource Protection: “Self-crediting,” in that minimizing the creation of new impervious cover results in a lower curve number (CN) and, consequently, a lower aquatic resource protection volume (ARP_v) on a development site.
- Overbank Flood Protection: “Self-crediting,” in that minimizing the creation of new impervious cover results in a lower curve number (CN) and, consequently, a lower overbank peak discharge (Q_{p25}) on a development site.
- Extreme Flood Protection: “Self-crediting,” in that minimizing the creation of new impervious cover results in a lower curve number (CN) and, consequently, a lower extreme peak discharge (Q_{p100}) on a development site.

7.7.6 Reduce Driveway Lengths and Widths

Description

Reduced driveway lengths and widths should be used to help reduce the creation of new impervious cover on development sites.

<u>KEY CONSIDERATIONS</u>	<u>USING THIS TECHNIQUE</u>
<ul style="list-style-type: none"> • Helps minimize the creation of new impervious cover on development sites • Helps maintain pre-development site hydrology by reducing post-construction stormwater runoff rates, volumes and pollutant loads • Reduces costs associated with driveway construction and maintenance 	<ul style="list-style-type: none"> ☑ Consider alternative site designs that reduce overall driveway length ☑ Minimize driveway width by using narrower or shared sidewalk designs

Discussion

Given that as much as 20% of the impervious cover found in a typical residential subdivision consists of sidewalks and driveways (CWP, 1998), site planning and design teams are encouraged to reduce driveway lengths and widths on development sites. Methods that can be used to reduce driveway lengths and widths include:

- Evaluating alternative site layouts to see how much total driveway pavement they will require
- Reducing setbacks and frontages (Section 7.7.9)
- Using shared driveways (Figure 7.17)
- Using narrower driveway widths



Figure 7.17: Shared Driveway on a Residential Development Site
(Source: Center for Watershed Protection)

If driveway lengths and widths cannot be minimized using the methods described above, site planning and design teams should consider using alternative or permeable surfaces, such as crushed rock, crushed shells or permeable pavement (Section 7.8.4), for driveway construction.

Stormwater Management “Credits”

Reducing driveway lengths and widths on a development site can be thought of as a “self-crediting” stormwater management technique. Consequently, it has not been assigned any additional stormwater management “credits” beyond the implicit “credits” outlined below:

- Stormwater Runoff Reduction: “Self-crediting,” in that minimizing the creation of new impervious cover results in a lower volumetric runoff coefficient (R_v) and, consequently, a lower runoff reduction volume (RR_v) on a development site.

-
- Water Quality Protection: "Self-crediting," in that minimizing the creation of new impervious cover results in a lower volumetric runoff coefficient (R_v) and, consequently, a lower runoff reduction volume (RR_v) on a development site.
 - Aquatic Resource Protection: "Self-crediting," in that minimizing the creation of new impervious cover results in a lower curve number (CN) and, consequently, a lower aquatic resource protection volume (ARP_v) on a development site.
 - Overbank Flood Protection: "Self-crediting," in that minimizing the creation of new impervious cover results in a lower curve number (CN) and, consequently, a lower overbank peak discharge (Q_{p25}) on a development site.
 - Extreme Flood Protection: "Self-crediting," in that minimizing the creation of new impervious cover results in a lower curve number (CN) and, consequently, a lower extreme peak discharge (Q_{p100}) on a development site.

7.7.7 Reduce Sidewalk Lengths and Widths

Description

Reduced sidewalk lengths and widths should be used to help reduce the creation of new impervious cover on development sites.

<u>KEY CONSIDERATIONS</u>	<u>USING THIS TECHNIQUE</u>
<ul style="list-style-type: none"> • Helps minimize the creation of new impervious cover on development sites • Helps maintain pre-development site hydrology by reducing post-construction stormwater runoff rates, volumes and pollutant loads • Reduces costs associated with sidewalk construction and maintenance 	<ul style="list-style-type: none"> ☑ Consider alternative site designs that reduce overall sidewalk length ☑ Minimize sidewalk width by using narrower or alternative sidewalk designs

Discussion

Given that as much as 20% of the impervious cover found in a typical residential subdivision consists of sidewalks and driveways (CWP, 1998), site planning and design teams are encouraged to reduce sidewalk lengths and widths on development sites. Methods that can be used to reduce sidewalk lengths and widths include:

- Evaluating alternative site layouts to see how much total sidewalk pavement they will require
- Reducing setbacks and frontages (Section 7.7.9)
- Locating sidewalks on only one side of the street (Figure 7.18)
- Using sidewalk widths of six feet in areas that will see high foot traffic and sidewalk widths of four feet in areas that will see less use



Figure 7.18: Residential Development Site with Sidewalks on One Side of the Street
(Source: Center for Watershed Protection)

If sidewalk lengths and widths cannot be minimized using the methods described above, site planning and design teams should consider using alternative or permeable surfaces, such as crushed rock, crushed shells or permeable pavement (Section 7.8.4), for sidewalk construction.

Stormwater Management “Credits”

Reducing sidewalks lengths and widths on a development site can be thought of as a “self-crediting” stormwater management technique. Consequently, it has not been assigned any additional stormwater management “credits” beyond the implicit “credits” outlined below:

- Stormwater Runoff Reduction: “Self-crediting,” in that minimizing the creation of new impervious cover results in a lower volumetric runoff coefficient (R_v) and, consequently, a lower runoff reduction volume (RR_v) on a development site.

- Water Quality Protection: "Self-crediting," in that minimizing the creation of new impervious cover results in a lower volumetric runoff coefficient (R_v) and, consequently, a lower runoff reduction volume (RR_v) on a development site.
- Aquatic Resource Protection: "Self-crediting," in that minimizing the creation of new impervious cover results in a lower curve number (CN) and, consequently, a lower aquatic resource protection volume (ARP_v) on a development site.
- Overbank Flood Protection: "Self-crediting," in that minimizing the creation of new impervious cover results in a lower curve number (CN) and, consequently, a lower overbank peak discharge (Q_{p25}) on a development site.
- Extreme Flood Protection: "Self-crediting," in that minimizing the creation of new impervious cover results in a lower curve number (CN) and, consequently, a lower extreme peak discharge (Q_{p100}) on a development site.

7.7.8 Reduce Building Footprints

Description

Consider using taller building designs to reduce the amount of impervious cover created by commercial buildings, multi-family residential buildings (e.g., apartment buildings) and other structures on development sites.

<u>KEY CONSIDERATIONS</u>	<u>USING THIS TECHNIQUE</u>
<ul style="list-style-type: none"> • Helps minimize the creation of new impervious cover on development sites • Helps maintain pre-development site hydrology by reducing post-construction stormwater runoff rates, volumes and pollutant loads 	<ul style="list-style-type: none"> ☑ Consider taller and alternative building designs that have smaller impervious footprints

Discussion

The amount of new impervious cover created on development sites can be reduced by designing taller commercial and multi-family residential buildings (e.g., apartment buildings) that have the same amount of livable space as shorter building designs (Figure 7.19). Site planning and design teams are also encouraged to consider consolidating multiple buildings to create single structures that have smaller impervious footprints.

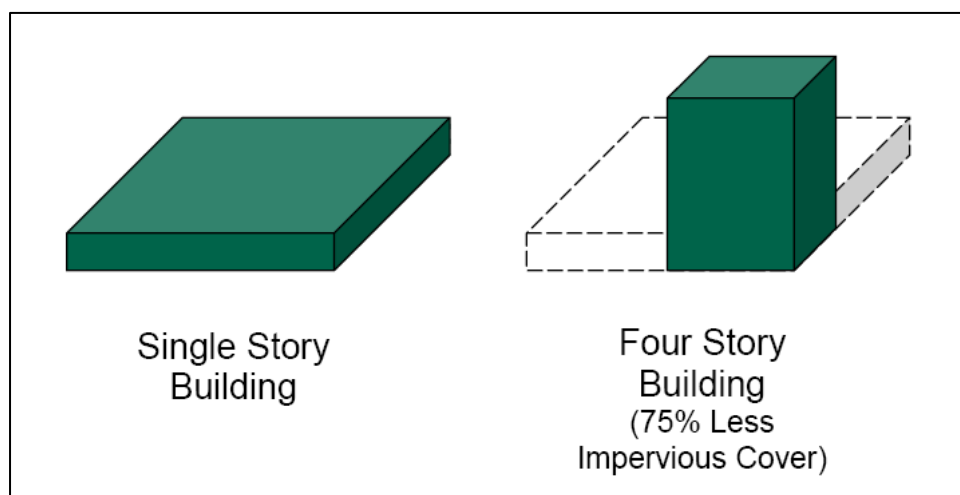

Figure 7.19: Reducing Building Footprints Can Help Reduce the Amount of Impervious Cover Created on Development Sites
 (Source: Atlanta Regional Commission, 2001)

Stormwater Management “Credits”

Reducing building footprints on a development site can be thought of as a “self-crediting” stormwater management technique. Consequently, it has not been assigned any additional stormwater management “credits” beyond the implicit “credits” outlined below:

- Stormwater Runoff Reduction: “Self-crediting,” in that minimizing the creation of new impervious cover results in a lower volumetric runoff coefficient (R_v) and, consequently, a lower runoff reduction volume (RR_v) on a development site.

-
- Water Quality Protection: "Self-crediting," in that minimizing the creation of new impervious cover results in a lower volumetric runoff coefficient (R_v) and, consequently, a lower runoff reduction volume (RR_v) on a development site.
 - Aquatic Resource Protection: "Self-crediting," in that minimizing the creation of new impervious cover results in a lower curve number (CN) and, consequently, a lower aquatic resource protection volume (ARP_v) on a development site.
 - Overbank Flood Protection: "Self-crediting," in that minimizing the creation of new impervious cover results in a lower curve number (CN) and, consequently, a lower overbank peak discharge (Q_{p25}) on a development site.
 - Extreme Flood Protection: "Self-crediting," in that minimizing the creation of new impervious cover results in a lower curve number (CN) and, consequently, a lower extreme peak discharge (Q_{p100}) on a development site.

7.7.9 Reduce Setbacks and Frontages

Description

Consider using smaller setbacks and narrower frontages in order to reduce roadway, driveway and sidewalk lengths and help minimize the creation of new impervious cover on development sites.

<u>KEY CONSIDERATIONS</u>	<u>USING THIS TECHNIQUE</u>
<ul style="list-style-type: none"> • Helps minimize the creation of new impervious cover on development sites • Helps maintain pre-development site hydrology by reducing post-construction stormwater runoff rates, volumes and pollutant loads 	<input checked="" type="checkbox"/> Consider alternative lot designs that feature reduced setbacks and frontages

Discussion

Smaller building setbacks and narrower frontages can be used to reduce roadway, driveway and sidewalk lengths and help minimize the creation of new impervious cover on development sites. As shown in Figure 7.20, a smaller front yard setback of 20 feet (which is more than sufficient to allow a car to park in a driveway without encroaching into the public right-of-way) can be used to reduce the required length of driveways and sidewalks by more than 30 percent on development sites.

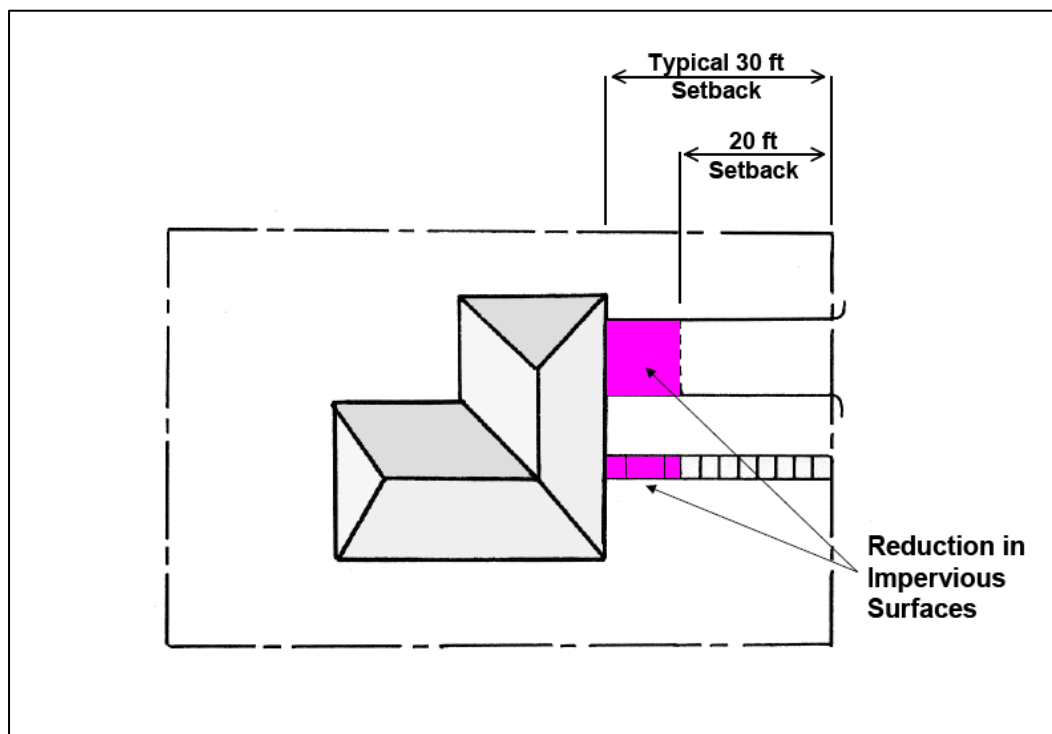

Figure 7.20: Reduced Front Yard Setbacks Results in the Creation of Less Impervious Cover on Development Sites
 (Source: Minnesota Pollution Control Agency, 1989)

Smaller side yard setbacks and narrower frontages can also help minimize the creation of new impervious cover on development sites. Both of these techniques can be used help create more compact site designs that require smaller amounts of roadway, driveway and sidewalk pavement. Figure 7.21 illustrates how reduced side yard setbacks and narrower frontages can be used on residential development sites.



Figure 7.21: Reduced Side Yard Setbacks and Narrower Frontages Used on Residential Development Sites

(Source: Atlanta Regional Commission, 2001)

Smaller setbacks and narrower frontages also allow site planning and design teams to use flexible lot shapes (Figure 7.22) and create *conservation developments* (Box 6.1), which provide a host of environmental benefits that are typically more difficult to achieve on more conventional development projects. Conservation developments, also known as *open space developments* or *cluster developments*, provide for better natural resource protection on development sites and inherently limit increases in site imperviousness, sometimes by as much as 40 to 60 percent (CWP, 1998).

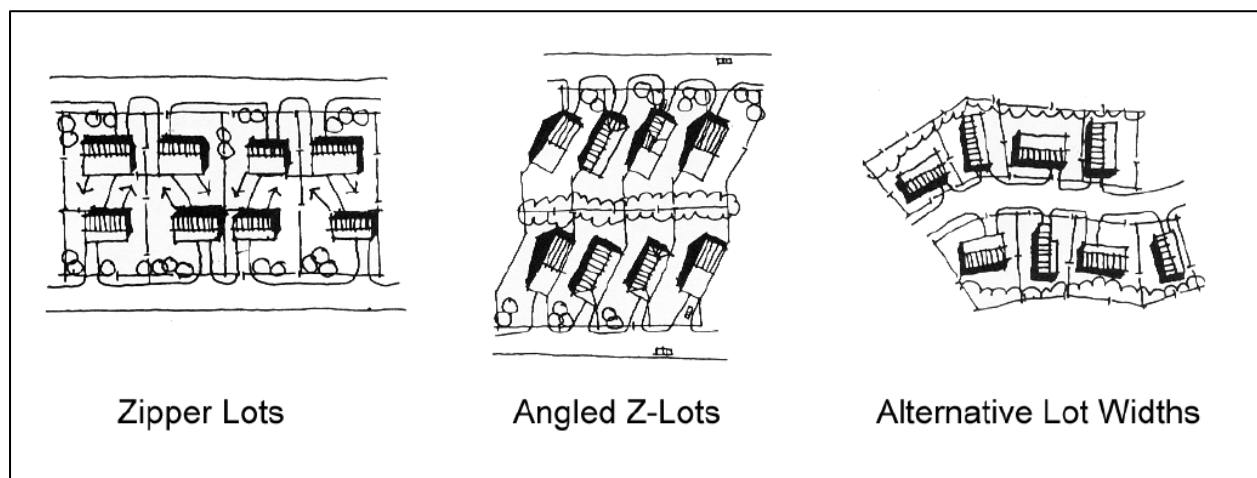

Zipper Lots

Angled Z-Lots

Alternative Lot Widths

Figure 7.22: Alternative Lot Designs

(Source: Center for Watershed Protection, 1998)

Stormwater Management “Credits”

Reducing setbacks and frontages on a development site can be thought of as a “self-crediting” stormwater management technique. Consequently, it has not been assigned any additional stormwater management “credits” beyond the implicit “credits” outlined below:

- Stormwater Runoff Reduction: “Self-crediting,” in that minimizing the creation of new impervious cover results in a lower volumetric runoff coefficient (R_v) and, consequently, a lower runoff reduction volume (RR_v) on a development site.
- Stormwater Runoff Reduction: “Self-crediting,” in that minimizing the creation of new impervious cover results in a lower volumetric runoff coefficient (R_v) and, consequently, a lower runoff reduction volume (RR_v) on a development site.
- Water Quality Protection: “Self-crediting,” in that minimizing the creation of new impervious cover results in a lower volumetric runoff coefficient (R_v) and, consequently, a lower runoff reduction volume (RR_v) on a development site.
- Aquatic Resource Protection: “Self-crediting,” in that minimizing the creation of new impervious cover results in a lower curve number (CN) and, consequently, a lower aquatic resource protection volume (ARP_v) on a development site.
- Overbank Flood Protection: “Self-crediting,” in that minimizing the creation of new impervious cover results in a lower curve number (CN) and, consequently, a lower overbank peak discharge (Q_{p25}) on a development site.
- Extreme Flood Protection: “Self-crediting,” in that minimizing the creation of new impervious cover results in a lower curve number (CN) and, consequently, a lower extreme peak discharge (Q_{p100}) on a development site.

THIS PAGE INTENTIONALLY LEFT BLANK

7.8 Low Impact Development Practice Profile Sheets

This Section contains profile sheets that provide information about the low impact development practices that are *recommended* for use in coastal Georgia. The profile sheets describe each of the low impact development practices, discuss how to properly apply and design them on development sites and provide information about how they can be used to help satisfy the SWM Criteria presented in this CSS. The low impact development practices profiled in this Section include:

Alternatives to Disturbed Pervious Surfaces

- 7.8.1 Soil Restoration
- 7.8.2 Site Reforestation/Revegetation

Alternatives to Impervious Surfaces

- 7.8.3 Green Roofs
- 7.8.4 Permeable Pavement

"Receiving" Low Impact Development Practices

- 7.8.5 Undisturbed Pervious Areas
- 7.8.6 Vegetated Filter Strips
- 7.8.7 Grass Channels
- 7.8.8 Simple Downspout Disconnection
- 7.8.9 Rain Gardens
- 7.8.10 Stormwater Planters
- 7.8.11 Dry Wells
- 7.8.12 Rainwater Harvesting
- 7.8.13 Bioretention Areas
- 7.8.14 Infiltration Practices
- 7.8.15 Dry Swales

THIS PAGE INTENTIONALLY LEFT BLANK

7.8.1 Soil Restoration

Description

Soil restoration refers to the process of tilling and adding compost and other amendments to soils to restore them to their pre-development conditions, which improves their ability to reduce post-construction stormwater runoff rates, volumes and pollutant loads. The soil restoration process can be used to improve the hydrologic conditions of pervious areas that have been disturbed by clearing, grading and other land disturbing activities. It can also be used to increase the reduction in stormwater runoff rates, volumes and pollutant loads provided by other low impact development practices.



(Source: <http://www.towncountryltd.com>)

<p style="text-align: center;"><u>KEY CONSIDERATIONS</u></p> <p>DESIGN CRITERIA:</p> <ul style="list-style-type: none"> • Ideal for use in pervious areas that have been disturbed by clearing, grading and other land disturbing activities • To properly restore disturbed pervious areas, soil amendments should be added to existing soils to a depth of 18 inches until an organic matter content of 8% to 12% is obtained • Restored pervious areas should be protected from future land disturbing activities <p>BENEFITS:</p> <ul style="list-style-type: none"> • Helps restore pre-development hydrology on development sites and reduces post-construction stormwater runoff rates, volumes and pollutant loads • Promotes plant growth and improves plant health, which helps reduce stormwater runoff rates, volumes and pollutant loads <p>LIMITATIONS:</p> <ul style="list-style-type: none"> • Should not be used on areas that have slopes of greater than 10% • To help prevent soil erosion, landscaping should be installed immediately after the soil restoration process is complete 	<p style="text-align: center;"><u>STORMWATER MANAGEMENT "CREDITS"</u></p> <ul style="list-style-type: none"> <input checked="" type="checkbox"/> Runoff Reduction <input checked="" type="checkbox"/> Water Quality Protection <input checked="" type="checkbox"/> Aquatic Resource Protection <input checked="" type="checkbox"/> Overbank Flood Protection <input checked="" type="checkbox"/> Extreme Flood Protection <p><input checked="" type="checkbox"/> = practice has been assigned quantifiable stormwater management "credits" that can be used to address this SWM Criteria</p>						
<p style="text-align: center;"><u>SITE APPLICABILITY</u></p> <table border="0"> <tr> <td><input checked="" type="checkbox"/> Rural Use</td> <td><input type="checkbox"/> Construction Cost</td> </tr> <tr> <td><input checked="" type="checkbox"/> Suburban Use</td> <td><input type="checkbox"/> Maintenance</td> </tr> <tr> <td><input checked="" type="checkbox"/> Urban Use</td> <td><input type="checkbox"/> Area Required</td> </tr> </table>	<input checked="" type="checkbox"/> Rural Use	<input type="checkbox"/> Construction Cost	<input checked="" type="checkbox"/> Suburban Use	<input type="checkbox"/> Maintenance	<input checked="" type="checkbox"/> Urban Use	<input type="checkbox"/> Area Required	<p style="text-align: center;"><u>STORMWATER MANAGEMENT PRACTICE PERFORMANCE</u></p> <p>Runoff Reduction N/A¹ - Annual Runoff Volume N/A¹ - Runoff Reduction Volume</p> <p>Pollutant Removal N/A¹ - Total Suspended Solids N/A¹ - Total Phosphorus N/A¹ - Total Nitrogen N/A¹ - Metals N/A¹ - Pathogens</p> <p>¹ = helps restore pre-development hydrology, which implicitly reduces post-construction stormwater runoff rates, volumes and pollutant loads</p>
<input checked="" type="checkbox"/> Rural Use	<input type="checkbox"/> Construction Cost						
<input checked="" type="checkbox"/> Suburban Use	<input type="checkbox"/> Maintenance						
<input checked="" type="checkbox"/> Urban Use	<input type="checkbox"/> Area Required						

Discussion

Soil restoration refers to the process of tilling and adding compost and other amendments to soils to restore them to their pre-development conditions. It is ideal for use on lawns and other pervious areas that have been disturbed by clearing, grading and other land disturbing activities. Organic compost (Figure 7.23) and other amendments can be tilled into soils in these areas to help create healthier, uncompacted soil matrices that have enough organic matter to support a diverse community of native trees, shrubs and other herbaceous plants.



Figure 7.23: Organic Compost
(Source: <http://www.organicgardeninfo.com>)

Soil restoration can also be used to increase the stormwater management benefits provided by other low impact development practices, such as site reforestation/revegetation (Section 7.8.2), vegetated filter strips (Section 7.8.6), grass channels (Section 7.8.7) and simple downspout disconnection (Section 7.8.8), on sites that have soils with low permeabilities (i.e., hydrologic soil group C or D soils). The soil restoration process can be used to help increase soil porosity and improve soil infiltration rates on these sites, which improves the ability of these and other low impact development practices to reduce post-construction stormwater runoff rates, volumes and pollutant loads.

Stormwater Management “Credits”

The Center for Watershed Protection (Hirschman et al., 2008) recently documented the ability of the soil restoration process to reduce annual stormwater runoff volumes and pollutant loads on development sites. Consequently, this low impact development practice has been assigned quantifiable stormwater management “credits” that can be used to help satisfy the SWM Criteria presented in this CSS:

- **Stormwater Runoff Reduction:** Subtract 50% of any *restored pervious areas* from the total site area and re-calculate the runoff reduction volume (RR_v) that applies to the development site.
- **Water Quality Protection:** Subtract 50% of any *restored pervious areas* from the total site area and re-calculate the runoff reduction volume (RR_v) that applies to the development site.
- **Aquatic Resource Protection:** Assume that the post-development hydrologic conditions of any *restored pervious areas* are equivalent to those of open space (e.g., lawns, parks, golf courses) in good condition.
- **Overbank Flood Protection:** Assume that the post-development hydrologic conditions of any *restored pervious areas* are equivalent to those of open space (e.g., lawns, parks, golf courses) in good condition.
- **Extreme Flood Protection:** Assume that the post-development hydrologic conditions of any *restored pervious areas* are equivalent to those of open space (e.g., lawns, parks, golf courses) in good condition.

In order to be eligible for these “credits,” it is *recommended* that restored pervious areas satisfy the planning and design criteria outlined below.

If any type of vegetation other than managed turf can be planted on a restored pervious area, site planning and design teams are encouraged to combine soil restoration with site reforestation/revegetation (Section 7.8.2) to further reduce post-construction stormwater runoff rates, volumes and pollutant loads.

When soil restoration is used to enhance the performance of other low impact development practices (e.g., site reforestation/revegetation, vegetated filter strips, grass channels), it may be “credited” as described in the appropriate low impact development practice profile sheet.

Overall Feasibility

The criteria listed in Table 7.6 should be evaluated to determine whether or not soil restoration is appropriate for use on a development site.

Table 7.6: Factors to Consider When Evaluating the Overall Feasibility of Using Soil Restoration on a Development Site	
Site Characteristic	Criteria
Drainage Area	N/A
Area Required	No restrictions
Slope	Maximum 10% in the disturbed pervious area to be restored.
Minimum Head	N/A
Minimum Depth to Water Table	A separation distance of 18 inches is recommended between the surface of a restored pervious area and the top of the water table.
Soils	Pervious areas that have soils with low permeabilities (i.e., hydrologic soil group C or D soils) or that have been disturbed by land disturbing activities are good candidates for soil restoration. Areas that have permeable soils (i.e., hydrologic soil group A or B soils) and that have not been disturbed by land disturbing activities do not need to be restored.

Site Applicability

Soil restoration can be used on a wide variety of development sites, including residential, commercial, industrial and institutional development sites in rural, suburban and urban areas. When compared with other low impact development practices, it has a moderate construction cost, a relatively low maintenance burden and requires no additional surface area beyond that which will undergo the soil restoration process. It is ideal for use in pervious areas that have been disturbed by clearing, grading and other land disturbing activities.

Planning and Design Criteria

It is *recommended* that the soil restoration process used on a development site meet all of the following criteria to be eligible for the stormwater management “credits” described above:

General Planning and Design

- To avoid damaging existing root systems, soil restoration should not be performed in areas that fall within the drip line of existing trees.
- Compost should be incorporated into existing soils, using a rototiller or similar equipment, to a depth of 18 inches and at an application rate necessary to obtain a final average organic matter content of 8%-12%. Required application rates can be determined using a compost calculator, such as the one provided on the following website: <http://www.soilsforalmon.org/resources.htm>.

- Only well-aged composts that have been composted for a period of at least one year should be used to amend existing soils. Composts should be stable and show no signs of further decomposition.
- Composts used to amend existing soils should meet the following specifications (most compost suppliers will be able to provide this information):
 - Organic Content Matter: Composts should contain 35%-65% organic matter.
 - Moisture Content: Composts should have a moisture content of 40%-60%.
 - Bulk Density: Composts should have an "as-is" bulk density of 40-50 pounds per cubic foot (lb/cf). In composts that have a moisture content of 40%-60%, this equates to a bulk density range of 450-800 pounds per cubic yard (lb/cy), by dry weight.
 - Carbon to Nitrogen (C:N) Ratio: Composts should have a C:N Ratio of less than 25:1.
 - pH: Composts should have a pH of 6-8.
 - Cation Exchange Capacity (CEC): Composts should have a CEC that exceeds 50 milliequivalents (meq) per 100 grams of dry weight.
 - Foreign Material Content: Composts should contain less than 0.5% foreign materials (e.g., glass, plastic), by weight.
 - Pesticide Content: Composts should be pesticide free.
- The use of biosolids (except Class 1 biosolids) and composted animal manure to amend existing soils is not recommended.
- It is recommended that composts used to amend existing soils be provided by a member of the U.S. Composting Seal of Testing Assurance program. Additional information on the Seal of Testing Assurance program is available on the following website: <http://www.compostingcouncil.org>.

Landscaping

- Vegetation commonly planted on restored pervious areas includes turf, shrubs, trees and other herbaceous vegetation. Although managed turf is most commonly used, site planning and design teams are encouraged to use trees, shrubs and/or other native vegetation to help establish mature native plant communities (e.g., forests) in restored pervious areas.
- Methods used to establish vegetative cover within a restored pervious area should achieve at least 75 percent vegetative cover one year after installation.
- To help prevent soil erosion and sediment loss, landscaping should be installed immediately after the soil restoration process is complete. Temporary irrigation may be needed to quickly establish vegetative cover on a restored pervious area.

Construction Considerations

To help ensure that the soil restoration process is successfully completed on a development site, site planning and design teams should consider the following recommendations:

- To help minimize compaction, heavy vehicular and foot traffic should be kept out of all restored pervious areas during and after construction. This can typically be accomplished by clearly delineating soil restoration areas on all development plans and, if necessary, protecting them with temporary construction fencing.
- Simple erosion and sediment control measures, such as temporary seeding and erosion control mats, should be used on restored pervious areas that exceed 2,500 square feet in size. If the restored pervious areas will "receive" any stormwater runoff from other portions of the development site, measures should be taken (e.g., silt fence, temporary diversion berm) to prevent it from compromising the soil restoration effort.

- Test pits or a rod penetrometer can be used to verify that soil amendments have reached a depth of 18 inches.
- Construction contracts should contain a replacement warranty that covers at least three growing seasons to help ensure adequate growth and survival of the vegetation planted on a restored pervious area.

Maintenance Requirements

Restored pervious areas require some maintenance during the first few months following construction, but typically require very little maintenance after that. Table 7.7 provides a list of the routine maintenance activities typically associated with restored pervious areas.

Activity	Schedule
<ul style="list-style-type: none"> • Water to promote plant growth and survival. • Inspect restored pervious area following rainfall events. Plant replacement vegetation in any eroded areas. 	As Needed (Following Construction)
<ul style="list-style-type: none"> • Inspect restored pervious area for erosion. Plant replacement vegetation in any eroded areas. • Inspect restored pervious area for dead or dying vegetation. Plant replacement vegetation as needed. 	Annually (Semi-Annually During First Year)

Additional Resources

Stenn, H. 2007. *Building Soil: Guidelines and Resources for Implementing Soil Quality and Depth BMP T5.13 in Washington Department of Ecology (WDOE) Stormwater Management Manual for Western Washington*. Public Works Department. Snohomish County, WA. Available Online: <http://www.soilsforsalmon.org/resources.htm>.

Washington Department of Ecology (WDOE). 2005. "BMP T5.13: Post-Construction Soil Quality and Depth." *Stormwater Management Manual for Western Washington*. Volume 5: Runoff Treatment BMPs. Washington Department of Ecology. Water Quality Program. Available Online: <http://www.ecy.wa.gov/programs/wq/stormwater/manual.html>.

Pennsylvania Department of Environmental Protection (PA DEP). 2006. "BMP 6.7.3: Soil Amendment and Restoration." *Pennsylvania Stormwater Best Management Practices Manual*. Pennsylvania Department of Environmental Protection. Bureau of Watershed Management. Available Online: <http://www.depweb.state.pa.us/watershedmgmt/site/default.asp>.

THIS PAGE INTENTIONALLY LEFT BLANK

7.8.2 Site Reforestation/Revegetation

Description

Site reforestation/revegetation refers to the process of planting trees, shrubs and other native vegetation in disturbed pervious areas to restore them to their pre-development conditions. The process can be used to help establish mature native plant communities (e.g., forests) in pervious areas that have been disturbed by clearing, grading and other land disturbing activities, which improves their ability to reduce post-construction stormwater runoff rates, volumes and pollutant loads. The process can also be used to provide restored habitat for high priority plant and animal species (Appendix A).



(Source: Center for Watershed Protection)

<p style="text-align: center;"><u>KEY CONSIDERATIONS</u></p> <p>DESIGN CRITERIA:</p> <ul style="list-style-type: none"> • Ideal for use in pervious areas that have been disturbed by clearing, grading and other land disturbing activities • Methods used for site reforestation/revegetation should achieve at least 75% vegetative cover one year after installation • Reforested/revegetated areas should be protected in perpetuity as secondary conservation areas (Section 7.6.2) <p>BENEFITS:</p> <ul style="list-style-type: none"> • Helps restore pre-development hydrology on development sites and reduces post-construction stormwater runoff rates, volumes and pollutant loads • Helps restore habitat for priority plant and animal species <p>LIMITATIONS:</p> <ul style="list-style-type: none"> • Should have a minimum contiguous area of 10,000 square feet • Should be managed in a natural state and protected from future land disturbing activities 	<p style="text-align: center;"><u>STORMWATER MANAGEMENT "CREDITS"</u></p> <ul style="list-style-type: none"> <input checked="" type="checkbox"/> Runoff Reduction <input checked="" type="checkbox"/> Water Quality Protection <input checked="" type="checkbox"/> Aquatic Resource Protection <input checked="" type="checkbox"/> Overbank Flood Protection <input checked="" type="checkbox"/> Extreme Flood Protection <p><input checked="" type="checkbox"/> = practice has been assigned quantifiable stormwater management "credits" that can be used to address this SWM Criteria</p>						
<p style="text-align: center;"><u>SITE APPLICABILITY</u></p> <table border="0"> <tr> <td><input checked="" type="checkbox"/> Rural Use</td> <td><input type="checkbox"/> Construction Cost</td> </tr> <tr> <td><input checked="" type="checkbox"/> Suburban Use</td> <td><input type="checkbox"/> Maintenance</td> </tr> <tr> <td><input checked="" type="checkbox"/> Urban Use</td> <td><input type="checkbox"/> Area Required</td> </tr> </table>	<input checked="" type="checkbox"/> Rural Use	<input type="checkbox"/> Construction Cost	<input checked="" type="checkbox"/> Suburban Use	<input type="checkbox"/> Maintenance	<input checked="" type="checkbox"/> Urban Use	<input type="checkbox"/> Area Required	<p style="text-align: center;"><u>STORMWATER MANAGEMENT PRACTICE PERFORMANCE</u></p> <p>Runoff Reduction N/A¹ - Annual Runoff Volume N/A¹ - Runoff Reduction Volume</p> <p>Pollutant Removal N/A¹ - Total Suspended Solids N/A¹ - Total Phosphorus N/A¹ - Total Nitrogen N/A¹ - Metals N/A¹ - Pathogens</p> <p>¹ = helps restore pre-development hydrology, which implicitly reduces post-construction stormwater runoff rates, volumes and pollutant loads</p>
<input checked="" type="checkbox"/> Rural Use	<input type="checkbox"/> Construction Cost						
<input checked="" type="checkbox"/> Suburban Use	<input type="checkbox"/> Maintenance						
<input checked="" type="checkbox"/> Urban Use	<input type="checkbox"/> Area Required						

Discussion

Site reforestation/revegetation refers to the process of planting trees, shrubs and other native vegetation in disturbed pervious areas to restore them to their pre-development conditions (Figure 7.24). The process can be used to help establish mature native plant communities (e.g., forests) in pervious areas that have been disturbed by clearing, grading and other land disturbing activities. Mature plant communities intercept rainfall, increase evaporation and transpiration rates, slow and filter stormwater runoff and help improve soil porosity and infiltration rates (Cappiella et al., 2006a), which leads to reduced post-construction stormwater runoff rates, volumes and pollutant loads. The site reforestation/revegetation process can also be used to provide restored habitat for high priority plant and animal species (Appendix A).

Areas that have been reforested or revegetated should be maintained in an undisturbed, natural state over time. These areas should be designated as secondary conservation areas (Section 7.6.2) and protected in perpetuity through a legally enforceable conservation instrument (e.g., conservation easement, deed restriction). If properly maintained over time, these areas can help improve aesthetics on development sites, provide passive recreational opportunities and create valuable habitat for high priority plant and animal species.

To help create contiguous, interconnected green infrastructure corridors on development sites, site planning and design teams should strive to connect reforested or revegetated areas with one another and with other primary and secondary conservation areas through the use of nature trails, bike trails and other “greenway” areas.

Stormwater Management “Credits”

The Center for Watershed Protection (Hirschman et al., 2008) recently documented the ability of the site reforestation/revegetation process to reduce annual stormwater runoff volumes and pollutant loads on development sites. Consequently, this low impact development practice has been assigned quantifiable stormwater management “credits” that can be used to help satisfy the SWM Criteria presented in this CSS:

- **Stormwater Runoff Reduction:** Subtract 50% of any *reforested/revegetated areas* from the total site area and re-calculate the runoff reduction volume (RR_v) that applies to the development site.
- **Water Quality Protection:** Subtract 50% of any *reforested/revegetated areas* from the total site area and re-calculate the runoff reduction volume (RR_v) that applies to the development site.
- **Aquatic Resource Protection:** Assume that the post-development hydrologic conditions of any *reforested/revegetated areas* are equivalent to those of a similar cover type (e.g., meadow, brush, woods) in fair condition.



Figure 7.24: Active Replanting of Native Trees in a Disturbed Pervious Area

(Source: Center for Watershed Protection)

- Overbank Flood Protection: Assume that the post-development hydrologic conditions of any *reforested/revegetated areas* are equivalent to those of a similar cover type (e.g., meadow, brush, woods) in fair condition.
- Extreme Flood Protection: Assume that the post-development hydrologic conditions of any *reforested/revegetated areas* are equivalent to those of a similar cover type (e.g., meadow, brush, woods) in fair condition.

Reforested/revegetated areas can only be assumed to be in “fair” hydrologic condition due to the fact that it will take many years for them to mature and provide full stormwater management benefits.

If site reforestation/revegetation can be combined with soil restoration (Section 7.8.1) on a development site, the following stormwater management “credits” can be used to help satisfy the SWM Criteria presented in this CSS:

- Stormwater Runoff Reduction: Subtract 100% of any *restored and reforested/revegetated areas* from the total site area and re-calculate the runoff reduction volume (RR_v) that applies to the development site.
- Water Quality Protection: Subtract 100% of any *restored and reforested/revegetated areas* from the total site area and re-calculate the runoff reduction volume (RR_v) that applies to the development site.
- Aquatic Resource Protection: Assume that the post-development hydrologic conditions of any *restored and reforested/revegetated areas* are equivalent to those of a similar cover type (e.g., meadow, brush, woods) in good condition.
- Overbank Flood Protection: Assume that the post-development hydrologic conditions of any *restored and reforested/revegetated areas* are equivalent to those of a similar cover type (e.g., meadow, brush, woods) in good condition.
- Extreme Flood Protection: Assume that the post-development hydrologic conditions of any *restored and reforested/revegetated areas* are equivalent to those of a similar cover type (e.g., meadow, brush, woods) in good condition.

In order to be eligible for these “credits,” it is *recommended* that reforested/revegetated areas satisfy the planning and design criteria outlined below.

Overall Feasibility

The criteria listed in Table 7.8 should be evaluated to determine whether or not site reforestation/revegetation is appropriate for use on a development site.

Table 7.8: Factors to Consider When Evaluating the Overall Feasibility of Using Site Reforestation/Revegetation on a Development Site	
Site Characteristic	Criteria
Drainage Area	N/A
Area Required	Reforested/revegetated areas should be larger than 10,000 square feet in size in order to be eligible for the stormwater management “credits” assigned to this low impact development practice.
Slope	Maximum 25% in the disturbed pervious area to be reforested/revegetated.

Table 7.8: Factors to Consider When Evaluating the Overall Feasibility of Using Site Reforestation/Revegetation on a Development Site

Site Characteristic	Criteria
Minimum Head	N/A
Minimum Depth to Water Table	No restrictions
Soils	No restrictions

Site Applicability

Although it may be difficult to apply in urban areas, due to space constraints, site reforestation/revegetation can be used on a wide variety of development sites, including residential, commercial, industrial and institutional development sites in rural and suburban areas. When compared with other low impact development practices, it has a moderate construction cost, a relatively low maintenance burden and requires no additional surface area beyond that which will undergo the reforestation/revegetation process. It is ideal for use in pervious areas that have been disturbed by clearing, grading and other land disturbing activities.

Planning and Design Criteria

It is *recommended* that the reforestation/revegetation process used on a development site meet all of the following criteria to be eligible for the stormwater management "credits" described above:

General Planning and Design

- Reforested/revegetated areas should have a contiguous area of 10,000 square feet or more.
- Reforested/revegetated areas should not be disturbed after construction (except for disturbances associated with landscaping or removal of invasive vegetation).
- Reforested/revegetated areas should be protected, in perpetuity, from the direct impacts of the land development process by a legally enforceable conservation instrument (e.g., conservation easement, deed restriction).

Landscaping

- A landscaping plan should be prepared for all reforested/revegetated areas. The landscaping plan should be reviewed and approved by the local development review authority prior to construction.
- Landscaping commonly used in site reforestation/revegetation efforts includes native trees, shrubs and other herbaceous vegetation. Because the goal of the site reforestation/revegetation process is to establish a mature native plant community (e.g., forest), managed turf cannot be used to landscape reforested/revegetated areas.
- Methods used for site reforestation/revegetation should achieve at least 75 percent vegetative cover one year after installation.
- A long-term vegetation management plan should be developed for all reforested/revegetated areas. The plan should clearly specify how the area will be maintained in an undisturbed, natural state over time. Turf management is *not* considered to be an acceptable form of vegetation management. Consequently, only reforested/revegetated areas that remain in an undisturbed, natural state are eligible for this "credit" (i.e., pervious areas consisting of managed turf are *not* eligible for this "credit").

Construction Considerations

To help ensure that the site reforestation/revegetation process is successfully completed on a development site, site planning and design teams should consider the following recommendations:

- Document the condition of the reforested/revegetated area before, during and after the completion of the site reforestation/revegetation process.
- To help prevent soil compaction, heavy vehicular and foot traffic should be kept out of all reforested/revegetated areas before, during and after construction. This can typically be accomplished by clearly delineating reforested/revegetated areas on all development plans and, if necessary, protecting them with temporary construction fencing.
- Simple erosion and sediment control measures, such as temporary seeding and erosion control mats, should be used on reforested/revegetated areas that exceed 2,500 square feet in size. If the reforested/revegetated areas will “receive” any stormwater runoff from other portions of the development site, measures should be taken (e.g., silt fence, temporary diversion berm) to prevent it from compromising the reforestation/revegetation effort.
- Construction contracts should contain a replacement warranty that covers at least three growing seasons to help ensure adequate growth and survival of the vegetation planted on the reforested/revegetated area.

Maintenance Requirements

Reforested/revegetated areas require some maintenance during the first few months following construction, but typically require very little maintenance after that. Table 7.9 provides a list of the routine maintenance activities typically associated with reforested/revegetated areas.

Activity	Schedule
<ul style="list-style-type: none"> • Water to promote plant growth and survival. • Inspect reforested/revegetated area following rainfall events. Plant replacement vegetation in any eroded areas. 	As Needed (Following Construction)
<ul style="list-style-type: none"> • Inspect reforested/revegetated area for erosion. Plant replacement vegetation in any eroded areas. • Inspect reforested/revegetated area for dead or dying vegetation. Plant replacement vegetation as needed. • Prune and care for individual trees and shrubs as needed. 	Annually (Semi-Annually During First Year)

Additional Resources

Cappiella, K., T. Schueler and T. Wright. 2006a. *Urban Watershed Forestry Manual. Part 2: Conserving and Planting Trees at Development Sites*. NA-TP-01-06. US Department of Agriculture. Forest Service. Northeastern Area. State and Private Forestry. Newtown Square, PA. Available Online: http://www.cwp.org/Resource_Library/Special_Resource_Management/forestry.htm.

- Cappiella, K., T. Schueler, J. Tomlinson and T. Wright. 2006b. *Urban Watershed Forestry Manual. Part 3: Urban Tree Planting Guide*. NA-TP-01-06. US Department of Agriculture. Forest Service. Northeastern Area. State and Private Forestry. Newtown Square, PA. Available Online:
http://www.cwp.org/Resource_Library/Special_Resource_Management/forestry.htm.
- Minnesota Pollution Control Agency (MPCA). 2006. "Credit 2: Site Reforestation or Prairie Restoration Credit." *Minnesota Stormwater Manual*. Section 11.3.2. Minnesota Pollution Control Agency. Available Online:
<http://www.pca.state.mn.us/water/stormwater/stormwater-manual.html>.
- Pennsylvania Department of Environmental Protection (PA DEP). 2006. "BMP 6.7.3: Soil Amendment and Restoration." *Pennsylvania Stormwater Best Management Practices Manual*. Section 6.7.3. Pennsylvania Department of Environmental Protection. Bureau of Watershed Management. Available Online:
<http://www.depweb.state.pa.us/watershedmgmt/site/default.asp>.

7.8.3 Green Roofs

Description

Green roofs represent an alternative to traditional impervious roof surfaces. They typically consist of underlying waterproofing and drainage materials and an overlying engineered growing media that is designed to support plant growth. Stormwater runoff is captured and temporarily stored in the engineered growing media, where it is subjected to the hydrologic processes of evaporation and transpiration before being conveyed back into the storm drain system. This allows green roofs to provide measurable reductions in post-construction stormwater runoff rates, volumes and pollutant loads on development sites.



(Source: <http://www.greenroofs.com>)

<p style="text-align: center;"><u>KEY CONSIDERATIONS</u></p> <p>DESIGN CRITERIA:</p> <ul style="list-style-type: none"> • The use of extensive green roof systems (2" -6" deep) should be considered prior to the use of more complex and expensive intensive green roof systems • Engineered growing media should be a light-weight mix and should contain less than 10% organic material • Waterproofing materials should be protected from root penetration by an impermeable root barrier <p>BENEFITS:</p> <ul style="list-style-type: none"> • Helps reduce post-construction stormwater runoff rates, volumes and pollutant loads without consuming valuable land • Particularly well suited for use on urban development and redevelopment sites <p>LIMITATIONS:</p> <ul style="list-style-type: none"> • Can be difficult to establish vegetation in the harsh growing conditions found on rooftops in coastal Georgia • Green roofs can be difficult to install on rooftops with slopes of 10% or greater 	<p style="text-align: center;"><u>STORMWATER MANAGEMENT "CREDITS"</u></p> <ul style="list-style-type: none"> <input checked="" type="checkbox"/> Runoff Reduction <input checked="" type="checkbox"/> Water Quality Protection <input checked="" type="checkbox"/> Aquatic Resource Protection <input checked="" type="checkbox"/> Overbank Flood Protection <input checked="" type="checkbox"/> Extreme Flood Protection <p><input checked="" type="checkbox"/> = practice has been assigned quantifiable stormwater management "credits" that can be used to address this SWM Criteria</p>
<p style="text-align: center;"><u>SITE APPLICABILITY</u></p> <ul style="list-style-type: none"> * Rural Use <input checked="" type="checkbox"/> Suburban Use <input checked="" type="checkbox"/> Urban Use <input type="checkbox"/> Construction Cost <input type="checkbox"/> Maintenance <input type="checkbox"/> Area Required 	<p style="text-align: center;"><u>STORMWATER MANAGEMENT PRACTICE PERFORMANCE</u></p> <p>Runoff Reduction 50% - Annual Runoff Volume 60% - Runoff Reduction Volume</p> <p>Pollutant Removal¹ 80% - Total Suspended Solids 50% - Total Phosphorus 50% - Total Nitrogen N/A - Metals N/A - Pathogens</p> <p>1 = expected annual pollutant load removal</p>

Discussion

Green roofs (also known as *vegetated roofs* or *eco roofs*) represent an alternative to traditional impervious roof surfaces. They typically consist of underlying waterproofing and drainage materials and an overlying engineered growing media that is designed to support plant growth (Figure 7.25). Stormwater runoff is captured and temporarily stored in the engineered growing media, where it is subjected to the hydrologic processes of evaporation and transpiration, before being conveyed back into the storm drain system. This allows green roofs to provide measurable reductions in post-construction stormwater runoff rates, volumes and pollutant loads on development sites.

There are two different types of green roof systems: intensive green roof systems and extensive green roof systems. Intensive green roof systems (also known as *rooftop gardens*) have a thick layer of engineered growing media (i.e., 12 to 24 inches) that supports a diverse plant community that may even include trees (Figure 7.26). Extensive green roof systems typically have a much thinner layer of engineered growing media (i.e., 2 to 6 inches) that supports a plant community that is comprised primarily of drought tolerant vegetation (e.g., sedums, succulent plants) (Figure 7.27).

Extensive green roof systems, which can cost up to twice as much as traditional impervious roof surfaces, are much lighter and are less expensive than intensive green roof systems. Consequently, it is *recommended* that the use of extensive green roof systems be considered prior to the use of intensive green roof systems in coastal Georgia.

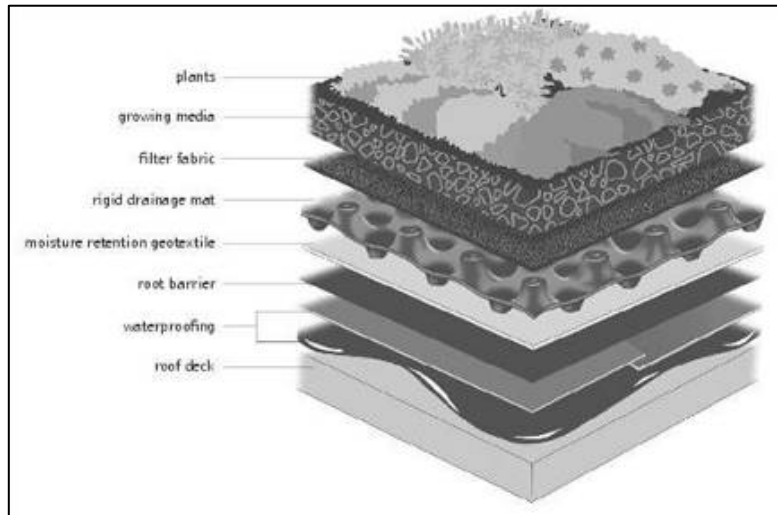

Figure 7.25: Components of a Green Roof System
(Source: Carter et al., 2007)

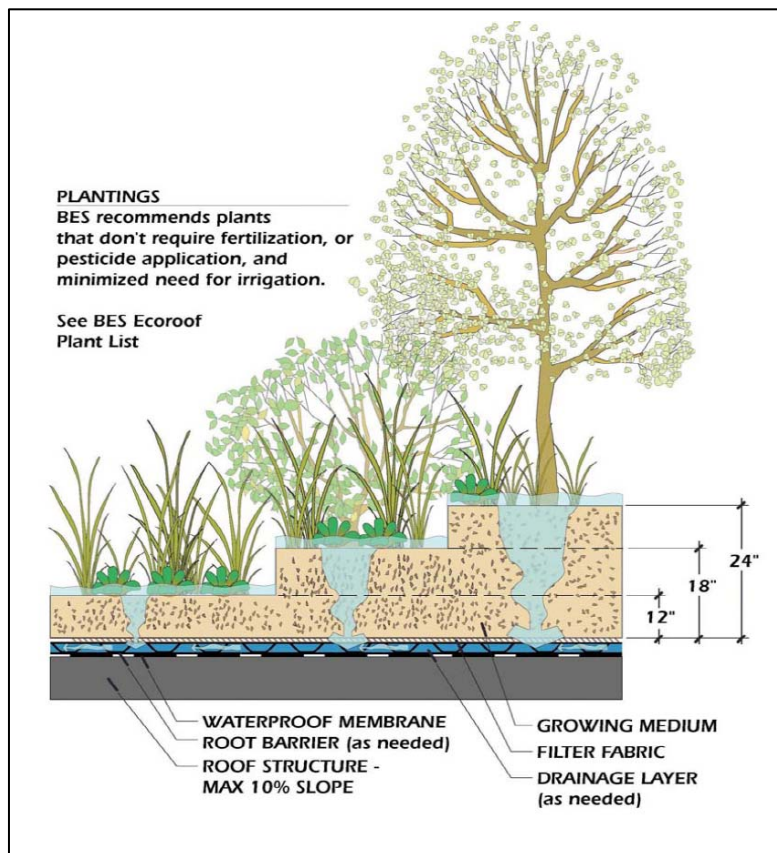

Figure 7.26: Intensive Green Roof System
(Source: City of Portland, OR, 2004)

Extensive green roof systems typically contain multiple layers of roofing materials (Figure 7.25), and are designed to support plant growth while preventing stormwater runoff from ponding on the roof surface. Green roof systems are designed to drain stormwater runoff vertically through the engineered growing media and then horizontally through a drainage layer towards an outlet. They are designed to require minimal long-term maintenance and, if the right plants are selected to populate the green roof, should not need supplemental irrigation or fertilization after an initial vegetation establishment period.

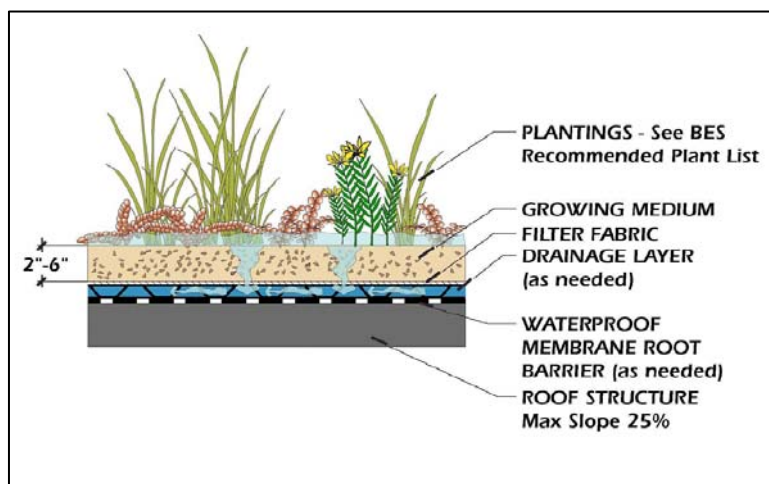

Figure 7.27: Extensive Green Roof System

(Source: City of Portland, OR, 2004)

When designing a green roof, site planning and design teams must not only consider the stormwater storage capacity of the green roof, but also the structural capacity of the rooftop itself. To support a green roof, a rooftop must be designed to support an additional 15 to 30 pounds per square foot (psf) of load. Consequently, a structural engineer or other qualified professional should be involved with the design of a green roof to ensure that the rooftop itself has enough structural capacity sufficient to support the green roof system.

Stormwater Management "Credits"

The Center for Watershed Protection (Hirschman et al., 2008) recently documented the ability of green roofs to reduce annual stormwater runoff volumes and pollutant loads on development sites. Consequently, this low impact development practice has been assigned quantifiable stormwater management "credits" that can be used to help satisfy the SWM Criteria presented in this CSS:

- Stormwater Runoff Reduction: Reduce the runoff reduction volume (RR_v) conveyed through a *green roof* by 60%.
- Water Quality Protection: Reduce the runoff reduction volume (RR_v) conveyed through a *green roof* by 60%.
- Aquatic Resource Protection: Proportionally adjust the post-development runoff curve number (CN) to account for the runoff reduction provided by a *green roof* when calculating the aquatic resource protection volume (ARP_v) on a development site.
- Overbank Flood Protection: Proportionally adjust the post-development runoff curve number (CN) to account for the runoff reduction provided by a *green roof* when calculating the overbank peak discharge (Q_{p25}) on a development site.
- Extreme Flood Protection: Proportionally adjust the post-development runoff curve number (CN) to account for the runoff reduction provided by a *green roof* when calculating the extreme peak discharge (Q_{p100}) on a development site.

In order to be eligible for these “credits,” it is *recommended* that green roofs satisfy the planning and design criteria outlined below.

Overall Feasibility

The criteria listed in Table 7.10 should be evaluated to determine whether or not a green roof is appropriate for use on a development site. It is important to note that green roofs have few constraints that impede their use on development sites.

Table 7.10: Factors to Consider When Evaluating the Overall Feasibility of Using a Green Roof on a Development Site	
Site Characteristic	Criteria
Drainage Area	Green roofs should only be used to replace traditional impervious roof surfaces. They should not be used to “receive” any stormwater runoff generated elsewhere on the development site.
Area Required	Green roofs require 100% of their contributing drainage areas.
Slope	Although green roofs may be installed on rooftops with slopes of up to 25%, it can be difficult to install them on rooftop with slopes of greater than 10%.
Minimum Head	6 to 12 inches
Minimum Depth to Water Table	N/A
Soils	An appropriate engineered growing media, consisting of approximately 80% lightweight inorganic material, 15% organic material and 5% sand, should be used in green roof systems.

Site Applicability

Green roofs can be used on a wide variety of development sites in rural, suburban and urban areas. They are especially well suited for use on commercial, institutional, municipal and multi-family residential buildings on urban and suburban development and redevelopment sites. When compared with other low impact development practices, green roofs have a relatively high construction cost, a relatively low maintenance burden and require no additional surface area beyond that which will be covered by the green roof. Although they can be expensive to install, green roofs are often a component of “green buildings,” such as those that achieve certification in the Leadership in Energy and Environmental Design (LEED) Green Building Rating System.

Planning and Design Criteria

It is *recommended* that green roofs meet all of the following criteria to be eligible for the stormwater management “credits” described above:

General Planning and Design

- All green roofs should be designed in accordance with the ASTM International Green Roof Standards (ASTM, 2005a, ASTM, 2005b, ASTM, 2005c, ASTM, 2005d, ASTM, 2006).
- Green roofs should only be used to replace traditional impervious roof surfaces. They should not be used to “receive” any stormwater runoff generated elsewhere on the development site.
- Although green roofs may be installed on rooftops with slopes of up to 25%, it can be difficult to install them on rooftops with slopes of greater than 10%. Supplemental measures, such as battens, may be needed to ensure stability against sliding on rooftops with slopes of greater than 10%.
- Green roof systems should be designed to provide enough storage for the stormwater runoff volume generated by the target runoff reduction rainfall event (e.g., 85th

percentile rainfall event). The required dimensions of a green roof system are governed by several factors, including the hydraulic conductivity and moisture retention capacity of the engineered growing media and the porosity of the underlying drainage layer. Site planning and design teams are encouraged to consult with green roof manufacturers and/or materials suppliers to design green roof systems that provide enough storage for the stormwater runoff volume generated by the target runoff reduction rainfall event (e.g., 85th percentile rainfall event).

- During the design of a green roof system, site planning and design teams should consider not only the storage capacity of the green roof, but also the structural capacity of the rooftop itself. A structural engineer or other qualified professional should be involved with the design of a green roof to ensure that the rooftop itself has enough structural capacity to support the green roof system.
- All green roof systems should include a waterproofing layer that will prevent stormwater runoff from damaging the underlying rooftop. Waterproofing materials typically used in green roof installations include reinforced thermoplastic and synthetic rubber membranes.
- The waterproofing layer should be protected from root penetration by an impermeable, physical root barrier. Chemical root barriers or physical root barriers that have been impregnated with pesticides, metals or other chemicals that may leach into post-construction stormwater runoff should not be used.
- A drainage layer should be placed between the root barrier and the engineered growing media. The drainage layer should consist of synthetic or inorganic materials (e.g., gravel, recycled polyethylene) that are capable of both retaining water and providing efficient drainage when the layer becomes saturated. The required depth of the drainage layer will be governed by the required storage capacity of the green roof system and by the structural capacity of the rooftop itself.
- An outlet (e.g., scupper and downspout) should be provided to convey stormwater runoff out of the drainage layer and off of the rooftop when the drainage layer becomes saturated.
- An appropriate engineered growing media, consisting of approximately 80% lightweight inorganic materials, 15% organic matter (e.g., well-aged compost) and 5% sand, should be installed above the drainage layer. The engineered growing media should have a maximum water retention capacity of approximately 30%.
- To prevent clogging within the drainage layer, the engineered growing media should be separated from the drainage layer by a layer of permeable filter fabric. The filter fabric should be a non-woven geotextile with a permeability that is greater than or equal to the hydraulic conductivity of the overlying engineered growing media.
- The engineered growing media should be between 4 and 6 inches deep, unless synthetic moisture retention materials (e.g., drainage mat with moisture storage "cups") are placed directly beneath the engineered growing media layer. When synthetic moisture retention materials are used, a 2 inch deep engineered growing media layer may be used.
- Consideration should be given to the stormwater runoff rates and volumes generated by larger storm events (e.g., 25-year, 24-hour storm event) to help ensure that these larger storm events are able to safely bypass the green roof system. An overflow system, such as a traditional rooftop drainage system with inlets set slightly above the elevation of the surface of the green roof, should be designed to convey the stormwater runoff generated by these larger storm events safely off of the rooftop.

Landscaping

- A landscaping plan should be prepared for all green roofs. The landscaping plan should be reviewed and approved by the local development review authority prior to construction.
- When developing a landscaping plan, site planning and design teams are encouraged consult with a botanist, landscape architect or other qualified professional to identify plants that will tolerate the harsh growing conditions found on rooftops in coastal Georgia. Planting recommendations for green roofs include:
 - Drought- and full sun-tolerant vegetation that requires minimal irrigation after establishment.
 - Low maintenance vegetation that is self-sustaining and does not require mowing, trimming or the use of fertilizers, pesticides or herbicides.
 - Vegetation that is fire resistant and able to withstand heat, cold and high winds.
- Since sedum and succulent plants possess many of the characteristics listed above, they are recommended for use on green roof systems installed in coastal Georgia. Herbs, forbs, grasses and other groundcovers may also be used, but these plants typically have higher watering and maintenance requirements.
- Methods used to establish vegetative cover on a green roof should achieve at least 75 percent vegetative cover one year after installation.

Construction Considerations

To help ensure that green roofs are properly installed on a development site, site planning and design teams should consider the following recommendations:

- To help prevent compaction of the engineered growing media, heavy foot traffic should be kept off of green roof surfaces during and after construction.
- Construction contracts should contain a replacement warranty that covers at least three growing seasons to help ensure adequate growth and survival of the vegetation planted on a green roof.

Maintenance Requirements

Maintenance is very important for green roofs, particularly in terms of ensuring that they continue to provide measurable stormwater management benefits over time. Consequently, a legally binding inspection and maintenance agreement and plan should be created to help ensure that they are properly maintained after construction is complete. Table 7.11 provides a list of the routine maintenance activities typically associated with green roofs.

Activity	Schedule
<ul style="list-style-type: none"> • Water to promote plant growth and survival. • Inspect green roof and replace any dead or dying vegetation. 	As Needed (Following Construction)
<ul style="list-style-type: none"> • Inspect waterproof membrane for leaks. Repair as needed. • Inspect outflow and overflow areas for sediment accumulation. Remove any accumulated sediment or debris. • Inspect green roof for dead or dying vegetation. Plant replacement vegetation as needed. 	Semi-Annually (Quarterly During First Year)

Additional Resources

ASTM International. 2005. *Standard Practice for Determination of Dead Loads and Live Loads Associated with Green Roof Systems*. Standard E2397-05. ASTM International. West Conshohocken, PA. Available Online: <http://www.astm.org/Standards/E2397.htm>.

ASTM International. 2006. *Standard Guide for Selection, Installation and Maintenance of Plants for Green Roof Systems*. Standard E2400-06. ASTM International. West Conshohocken, PA. Available Online: <http://www.astm.org/Standards/E2400.htm>.

City of Portland, OR. 2008. "Ecoroof." *Portland Stormwater Management Manual*. Section 2.3.3. City of Portland, OR. Bureau of Environmental Services. Available Online: <http://www.portlandonline.com/bes/index.cfm?c=47952>.

Pennsylvania Department of Environmental Protection (PA DEP). 2006. "BMP 6.5.1: Vegetated Roof." *Pennsylvania Stormwater Best Management Practices Manual*. Section 6.5.1. Pennsylvania Department of Environmental Protection. Bureau of Watershed Management. Available Online: <http://www.depweb.state.pa.us/watershedmgmt/site/default.asp>.

THIS PAGE INTENTIONALLY LEFT BLANK

7.8.4 Permeable Pavements

Description

Permeable pavements represent an alternative to traditional impervious paving surfaces. They typically consist of an underlying drainage layer and an overlying permeable surface layer. A permeable pavement system allows stormwater runoff to pass through the surface course (i.e., pavement surface) into an underlying stone reservoir, where it is temporarily stored and allowed to infiltrate into the surrounding soils or conveyed back into the storm drain system through an underdrain. This allows permeable pavement systems to provide measurable reductions in post-construction stormwater runoff rates, volumes and pollutant loads.



(Source: Center for Watershed Protection)

<p style="text-align: center;"><u>KEY CONSIDERATIONS</u></p> <p>DESIGN CRITERIA:</p> <ul style="list-style-type: none"> • Permeable pavement systems should be designed to completely drain within 48 hours of the end of a rainfall event • If the infiltration rate of the native soils located beneath a permeable pavement system do not meet or exceed 0.25 in/hr, an underdrain should be included in the design • Permeable pavement systems should generally not be used to “receive” any stormwater runoff generated elsewhere on the development site <p>BENEFITS:</p> <ul style="list-style-type: none"> • Helps reduce post-construction stormwater runoff rates, volumes and pollutant loads without consuming valuable land • Particularly well suited for use on urban development sites and in low traffic areas, such as overflow parking lots <p>LIMITATIONS:</p> <ul style="list-style-type: none"> • Relatively high construction costs, which are typically offset by savings on stormwater infrastructure (e.g., storm drain system) • Permeable pavement systems should be installed only by experienced personnel 	<p style="text-align: center;"><u>STORMWATER MANAGEMENT “CREDITS”</u></p> <ul style="list-style-type: none"> <input checked="" type="checkbox"/> Runoff Reduction <input checked="" type="checkbox"/> Water Quality Protection <input checked="" type="checkbox"/> Aquatic Resource Protection <input checked="" type="checkbox"/> Overbank Flood Protection <input checked="" type="checkbox"/> Extreme Flood Protection <p><input checked="" type="checkbox"/> = practice has been assigned quantifiable stormwater management “credits” that can be used to address this SWM Criteria</p>
<p style="text-align: center;"><u>SITE APPLICABILITY</u></p> <ul style="list-style-type: none"> * Rural Use <input checked="" type="checkbox"/> Suburban Use <input checked="" type="checkbox"/> Urban Use <input type="checkbox"/> Construction Cost <input type="checkbox"/> Maintenance <input type="checkbox"/> Area Required 	<p style="text-align: center;"><u>STORMWATER MANAGEMENT PRACTICE PERFORMANCE</u></p> <p>Runoff Reduction 45%-75% - Annual Runoff Volume Varies¹ - Runoff Reduction Volume</p> <p>Pollutant Removal² 80% - Total Suspended Solids 50% - Total Phosphorus 50% - Total Nitrogen 60% - Metals N/A - Pathogens</p> <p>1 = varies according to storage capacity of the permeable pavement system 2 = expected annual pollutant load removal</p>

Discussion

Permeable pavements represent an alternative to traditional impervious paving surfaces. They typically consist of an underlying drainage layer and an overlying permeable surface layer. A permeable pavement system allows stormwater runoff to pass through the surface course (i.e., pavement surface) into an underlying stone reservoir, where it is temporarily stored and allowed to infiltrate into the surrounding soils or conveyed back into the storm drain system through an underdrain (Figure 7.28). This allows permeable pavement systems to provide measurable reductions in post-construction stormwater runoff rates, volumes and pollutant loads on development sites.

There are a variety of permeable pavement surfaces available in the commercial marketplace, including pervious concrete, porous asphalt, permeable interlocking concrete pavers, concrete grid pavers and plastic grid pavers (Figure 7.29). Each of these permeable pavement surfaces is briefly described below:

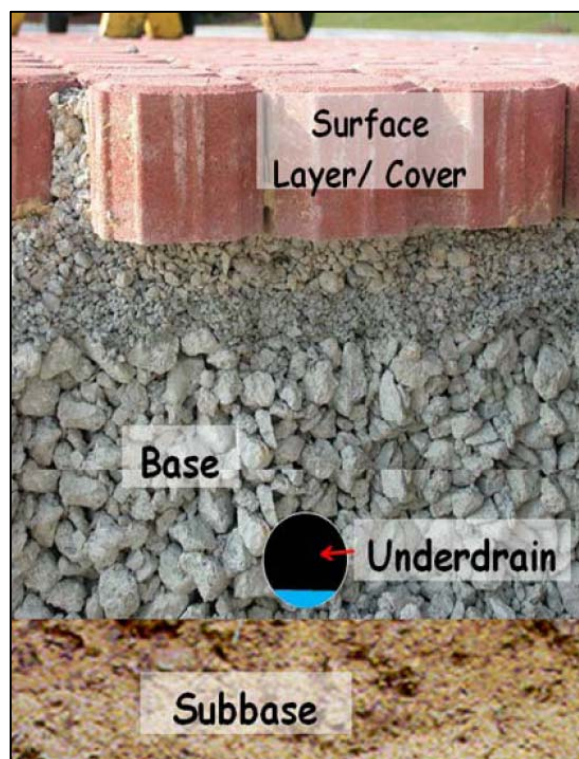

Figure 7.28: Components of a Permeable Pavement System

(Source: Hunt and Collins, 2008)

- **Pervious Concrete:** Pervious concrete (also known as *porous concrete*) is similar to conventional concrete in structure and form, but consists of a special open-graded surface course, typically 4 to 8 inches thick, that is bound together with portland cement. This open-graded surface course has a void ratio of 15% to 25% (conventional concrete pavement has a void ratio of between 3% and 5%), which gives it a high permeability that is often many times more than that of the underlying native soils, and allows rainwater and stormwater runoff to rapidly pass through it and into the underlying stone reservoir. Although this particular type permeable pavement surface may not require an underlying base layer to support traffic loads, site planning and design teams may wish to provide it to increase the stormwater storage capacity provided by a pervious concrete system.
- **Porous Asphalt:** Porous asphalt is similar to pervious concrete, and consists of a special open-graded surface course bound together by asphalt cement. The open-graded surface course in a typical porous asphalt installation is 3 to 7 inches thick and has a void ratio of between 15% and 20%. Porous asphalt is thought to have a limited ability to maintain its structure and permeability during hot summer months and, consequently, is currently *not recommended* for use in coastal Georgia. If it is used on a development site in the 24-county coastal region, it should be carefully monitored and maintained over time.
- **Permeable Interlocking Concrete Pavers:** Permeable interlocking concrete pavers (PICP) are solid structural units (e.g., blocks, bricks) that are installed in a way that provides regularly spaced openings through which stormwater runoff can rapidly pass through the pavement surface and into the underlying stone reservoir. The regularly spaced



Figure 7.29: Various Permeable Pavement Surfaces

openings, which generally make up between 8% and 20% of the total pavement surface, are typically filled with pea gravel (i.e., ASTM D 448 Size No. 8, 3/8" to 1/8"). Typical PICP systems consist of the pavers, a 1.5 to 3 inch thick fine gravel bedding layer and an underlying stone reservoir (Figure 7.28).

- **Concrete Grid Pavers:** Concrete grid pavers (CGP) are precast concrete units that allow rainfall and stormwater runoff to pass through large openings that are filled with gravel, sand or topsoil and turf (Figure 7.29). CGP are typically 3.5 inches thick and have between a void ratio of between 20% and 50%, which means that the material used to fill the spaces between the grids has a large influence on the overall permeability (i.e., void space) of a CGP system. A typical CGP installation consists of the pavers, a 1 to 1.5 inch sand or pea gravel bedding layer and an underlying stone reservoir.
- **Plastic Grid Pavers:** Plastic grid pavers (PGP) are similar to CGP. They consist of flexible, interlocking plastic units that allow rainfall and stormwater runoff to pass through large openings that are filled with gravel, sand or topsoil and turf (Figure 7.29). Since the empty plastic grids have a void ratio of between 90% and 98%, the material used to fill the

spaces between the grids has a large influence on the overall permeability (i.e., void space) a PGP system.

When designing a permeable pavement system, planning and design teams must not only consider the storage capacity of the system, but also the structural capacity of the underlying soils and the underlying stone reservoir. The infiltration rate and structural capacity of the native soils found on a development site directly influence the size of the stone reservoir that is needed to provide structural support for a permeable pavement system and measurable reductions in post-construction stormwater runoff rates, volumes and pollutant loads. Site planning and design teams should strive to design permeable pavement systems that can accommodate the stormwater runoff volume generated by the target runoff reduction rainfall event (e.g., 85th percentile rainfall event). If this cannot be accomplished, due to site characteristics or constraints, site planning and design teams should consider using permeable pavement systems in combination with other runoff reducing low impact development practices.

Although permeable pavement systems have seen some use in coastal Georgia, there is still limited experience with the design and installation of this low impact development within the region. On the national scale, permeable pavement installations have had high failure rates due to poor design, poor installation, underlying soils with low infiltration rates and poor maintenance practices (ARC, 2001). Consequently, if a permeable pavement system is used on a development site, it should be carefully monitored and maintained over time.

Stormwater Management “Credits”

The Center for Watershed Protection (Hirschman et al., 2008) recently documented the ability of permeable pavement systems to reduce annual stormwater runoff volumes and pollutant loads on development sites. Consequently, this low impact development practice has been assigned quantifiable stormwater management “credits” that can be used to help satisfy the SWM Criteria presented in this CSS:

- Stormwater Runoff Reduction: Subtract 100% of the storage volume provided by a non-underdrained *permeable pavement system* from the runoff reduction volume (RR_v) conveyed through the system. Subtract 50% of the storage volume provided by an underdrained *permeable pavement system* from the runoff reduction volume (RR_v) conveyed through the system.
- Water Quality Protection: Subtract 100% of the storage volume provided by a non-underdrained *permeable pavement system* from the runoff reduction volume (RR_v) conveyed through the system. Subtract 50% of the storage volume provided by an underdrained *permeable pavement system* from the runoff reduction volume (RR_v) conveyed through the system.
- Aquatic Resource Protection: Proportionally adjust the post-development runoff curve number (CN) to account for the runoff reduction provided by a *permeable pavement system* when calculating the aquatic resource protection volume (ARP_v) on a development site.
- Overbank Flood Protection: Proportionally adjust the post-development runoff curve number (CN) to account for the runoff reduction provided by a *permeable pavement system* when calculating the overbank peak discharge (Q_{p25}) on a development site.

- **Extreme Flood Protection:** Proportionally adjust the post-development runoff curve number (CN) to account for the runoff reduction provided by a *permeable pavement system* when calculating the extreme peak discharge (Q_{p100}) on a development site.

The storage volume provided by a permeable pavement system can be determined using the following equation:

$$\text{Storage Volume} = \text{Surface Area} \times \text{Depth} \times \text{Void Ratio}$$

A void ratio (i.e., void space/total volume) of 0.32 should be used in all storage volume calculations, unless more specific aggregate void ratio data are available.

In order to be eligible for these “credits,” it is *recommended* that permeable pavement systems satisfy the planning and design criteria outlined below.

Overall Feasibility

The criteria listed in Table 7.12 should be evaluated to determine whether or not a permeable pavement system is appropriate for use on a development site.

Table 7.12: Factors to Consider When Evaluating the Overall Feasibility of Using a Permeable Pavement System on a Development Site	
Site Characteristic	Criteria
Drainage Area	Permeable pavement systems should only be used to replace traditional impervious paving surfaces. They should not be used to “receive” any stormwater runoff generated elsewhere on the development site.
Area Required	Permeable pavement systems require 100% of their contributing drainage areas.
Slope	Although permeable pavement systems may be installed on development sites with slopes of up to 6%, they should be designed with slopes that are as close to flat as possible to help ensure that stormwater runoff is evenly distributed throughout the stone reservoir.
Minimum Head	2 to 4 feet
Minimum Depth to Water Table	2 feet
Soils	Permeable pavement systems should be designed to completely drain within 48 hours of the end of a rainfall event. Consequently, non-underdrained permeable pavement systems generally should not be used on development sites that have soils with infiltration rates of less than 0.25 inches per hour (i.e., hydrologic soil group C and D soils).

Feasibility in Coastal Georgia

Several site characteristics commonly encountered in coastal Georgia may present challenges to site planning and design teams that are interested in using permeable pavement on a development site. Table 7.13 identifies these common site characteristics and describes how they influence the use of permeable pavement systems on development sites. The table also provides site planning and design teams with some ideas about how they can work around these potential constraints.

Table 7.13: Challenges Associated with Using Permeable Pavement Systems in Coastal Georgia

Site Characteristic	How it Influences the Use of Permeable Pavement	Potential Solutions
<ul style="list-style-type: none"> <i>Poorly drained soils, such as hydrologic soil group C and D soils</i> 	<ul style="list-style-type: none"> Reduces the ability of permeable pavement systems to reduce stormwater runoff rates, volumes and pollutant loads. 	<ul style="list-style-type: none"> An underdrain should be included in permeable pavement systems that will be installed development sites that have soils with infiltration rates of less than 0.25 inches per hour (i.e., hydrologic soil group C and D soils). Use additional low impact development practices to supplement the stormwater management benefits provided by underdrained permeable pavement systems.
<ul style="list-style-type: none"> <i>Well drained soils, such as hydrologic soil group A and B soils</i> 	<ul style="list-style-type: none"> Enhances the ability of permeable pavement systems to reduce stormwater runoff rates, volumes and pollutant loads, but may allow stormwater pollutants to reach groundwater aquifers with greater ease. 	<ul style="list-style-type: none"> Avoid the use of infiltration-based low impact development practices, including non-underdrained permeable pavement systems, at stormwater hotspots and in areas known to provide groundwater recharge to water supply aquifers. Use permeable pavement systems with liners and underdrains at stormwater hotspots and in areas known to provide groundwater recharge to water supply aquifers.
<ul style="list-style-type: none"> <i>Flat terrain</i> 	<ul style="list-style-type: none"> Does not influence the use of permeable pavement systems. In fact, permeable pavement systems should be designed with slopes that are as close to flat as possible. 	
<ul style="list-style-type: none"> <i>Shallow water table</i> 	<ul style="list-style-type: none"> May cause stormwater runoff pond at the bottom of the permeable pavement system. 	<ul style="list-style-type: none"> Ensure that the distance from the bottom of the permeable pavement system to the top of the water table is at least 2 feet. Use stormwater ponds (Section 8.6.1) and stormwater wetlands (Section 8.6.2) to intercept and treat stormwater runoff in these areas.

Table 7.13: Challenges Associated with Using Permeable Pavement Systems in Coastal Georgia

Site Characteristic	How it Influences the Use of Permeable Pavement	Potential Solutions
<ul style="list-style-type: none"> <i>Tidally-influenced drainage system</i> 	<ul style="list-style-type: none"> May occasionally prevent stormwater runoff from being conveyed through a permeable pavement system, particularly during high tide. 	<ul style="list-style-type: none"> Investigate the use of other low impact development practices, such as rainwater harvesting (Section 7.8.12) to “receive” stormwater runoff in these areas.

Site Applicability

Permeable pavement systems can be used on a wide range of development sites in rural, suburban and urban areas. They are especially well suited for use on urban development and redevelopment sites to construct sidewalks, parking lots, overflow parking areas, private streets and driveways and parking lanes on public streets and roadways. When compared with other low impact development practices, permeable pavement systems have a relatively high construction cost, a relatively high maintenance burden and require no additional surface area beyond that which will be covered by the permeable pavement system.

Planning and Design Criteria

It is *recommended* that permeable pavement systems meet all of the following criteria to be eligible for the stormwater management “credits” described above:

General Planning and Design

- Permeable pavement systems should only be used to replace traditional impervious paving surfaces. They should not be used to “receive” any stormwater runoff generated elsewhere on the development site.
- Although permeable pavement systems may be installed on development sites with slopes of up to 6%, they should be designed with slopes that are as close to flat as possible to help ensure that stormwater runoff is evenly distributed throughout the stone reservoir.
- Permeable pavement systems can be designed without an underdrain on development sites that have underlying soils with an infiltration rate of 0.25 inches per hour (in/hr) or greater, as determined by NRCS soil survey data and subsequent field testing. Field infiltration test protocol, such as that provided by the City of Portland, OR (Portland, OR, 2008) on the following website: <http://www.portlandonline.com/shared/cfm/image.cfm?id= 202911>, can be used to conduct field testing, but should be approved by the local development review authority prior to use.
- Although the number of infiltration tests needed on a development site will ultimately be determined by the local development review authority, at least one infiltration test is recommended for every 5,000 square feet of permeable pavement that will be used on the development site. If the infiltration rate of the underlying soils on the development site is not 0.25 inches per hour (in/hr) or greater, an underdrain should be included in the permeable pavement system design.
- Since clay lenses or any other restrictive layers located below the bottom of a permeable pavement system will reduce soil infiltration rates, infiltration testing should be conducted within any confining layers that are found within 4 feet of the bottom of a proposed permeable pavement system.
- Permeable pavement systems should be designed to provide enough storage for the stormwater runoff volume generated by the target runoff reduction rainfall event (e.g.,

85th percentile rainfall event). Since they are essentially infiltration practices, the required dimensions of a non-underdrained permeable pavement system can be determined using the design procedures provided in Section 8.6.5 of this CSS. The required dimensions of an underdrained permeable pavement system can be determined by using the conveyance capacity of the selected underdrain system.

- Permeable pavement systems should be designed to completely drain within 48 hours of the end of a rainfall event. Where site characteristics allow, it is preferable to design permeable pavement systems to drain within 24 hours of the end of a rainfall event to help prevent the formation of nuisance ponding conditions.
- An appropriate permeable pavement surface should be selected for the intended application. The permeable pavement surface should be able to support the maximum projected traffic load.
- Most permeable pavement surfaces need to be supported by an underlying stone reservoir (also known as a *gravel base* or *aggregate base*). The depth of the stone reservoir typically ranges between 1 and 4 feet, but should be determined by considering both the required stormwater storage capacity and the maximum projected traffic load that will be experienced by the permeable pavement system. On most development sites, the maximum projected traffic load will determine the depth of the underlying stone reservoir.
- The stone reservoir should be filled with clean, washed stone. The stone used in the stone reservoir should be 1.5 to 2.5 inches in diameter, with a void space of approximately 40% (e.g., GA DOT No. 3 Stone). Unwashed aggregate contaminated with soil or other fines may not be used in the stone reservoir.
- If no underdrain is required, underlying native soils should be separated from the stone reservoir by a thin, 2 to 4 inch layer of choker stone (i.e., ASTM D 448 size No. 8, 3/8" to 1/8" or ASTM D 448 size No. 89, 3/8" to 1/16"). The choker stone should be placed between the stone reservoir and the underlying native soils.
- If an underdrain is required, it should be placed beneath the stone reservoir. The underdrain should consist of a 4 to 6 inch perforated PVC (AASHTO M 252) pipe bedded in an 8 inch layer of clean, washed stone. The pipe should have 3/8 inch perforations, spaced 6 inches on center, and should have a minimum slope of 0.5%. The clean, washed stone should be ASTM D448 size No. 57 stone (i.e., 1-1/2 to 1/2 inches in size) and should be separated from the stone reservoir by a thin, 2 to 4 inch layer of choker stone (i.e., ASTM D 448 size No. 8, 3/8" to 1/8" or ASTM D 448 size No. 89, 3/8" to 1/16").
- The sides of the stone reservoir should be lined with a layer of appropriate permeable filter fabric. The filter fabric should be a non-woven geotextile with a permeability that is greater than or equal to the infiltration rate of the surrounding native soils.
- The depth from the bottom of a permeable pavement system to the top of the water table should be at least 2 feet to prevent nuisance ponding and ensure proper operation of the permeable pavement system.
- To prevent damage to building foundations and contamination of groundwater aquifers permeable pavement systems, unless equipped with a waterproof liner (e.g., 30 mil (0.030 inch) polyvinylchloride (PVC) or equivalent), should be located at least:
 - 10 feet from building foundations
 - 10 feet from property lines
 - 100 feet from private water supply wells
 - 1,200 feet from public water supply wells
 - 100 feet from septic systems
 - 100 feet from surface waters
 - 400 feet from public water supply surface waters
- Consideration should be given to the stormwater runoff rates and volumes generated by larger storm events (e.g., 25-year, 24-hour storm event) to help ensure that these larger

storm events are able to safely bypass the permeable pavement system. An overflow system should be designed to convey the stormwater runoff generated by these larger storm events safely off of the pavement surface. Methods that can be used to accommodate the stormwater runoff rates and volumes generated by these larger storm events include:

- Allowing excess stormwater runoff to be safely conveyed off of the permeable pavement surface via sheet flow.
- Using storm drain inlets set slightly above the elevation of the permeable pavement surface to collect excess stormwater runoff. This will create some ponding on the surface of the permeable pavement system, but can be used to safely convey excess stormwater runoff off of the permeable pavement surface.
- Placing a perforated pipe (e.g., underdrain) near the top of the stone reservoir to provide additional conveyance of stormwater runoff after the stone reservoir has been filled.
- Placing an underground detention system (Section 8.7) beneath or adjacent to the permeable pavement system.

Construction Considerations

To help ensure that permeable pavement systems are successfully installed on a development site, site planning and design teams should consider the following recommendations:

- To help prevent soil compaction, heavy vehicular and foot traffic should be kept out of permeable pavement areas before, during and immediately after construction. This can typically be accomplished by clearly delineating permeable pavement areas on all development plans and, if necessary, protecting them with temporary construction fencing.
- Excavation for permeable pavement systems should be limited to the width and depth specified in the development plans. Excavated material should be placed away from the excavation so as not to jeopardize the stability of the side walls.
- The native soils along the bottom of the permeable pavement system should be scarified or tilled to a depth of 3 to 4 inches prior to the placement of the choker stone, underdrain and stone reservoir.
- The sides of all excavations should be trimmed of all large roots that will hamper the installation of the permeable filter fabric used to line the sides of the stone reservoir.

Maintenance Requirements

Maintenance is very important for permeable pavement systems, particularly in terms of ensuring that they continue to provide measurable stormwater management benefits over time. Consequently, a legally binding inspection and maintenance agreement and plan should be created to help ensure that they are properly maintained after construction is complete. Table 7.14 provides a list of the routine maintenance activities typically associated with permeable pavement systems.

Table 7.14: Routine Maintenance Activities Typically Associated with Permeable Pavement Systems

Activity	Schedule
<ul style="list-style-type: none"> • Inspect to ensure that the permeable pavement surface is clear of sediment and debris. Remove any accumulated sediment and debris. • Check the permeable pavement system for excessive ponding and dead or dying vegetation (if applicable). Take appropriate remedial action as needed. 	Monthly

Table 7.14: Routine Maintenance Activities Typically Associated with Permeable Pavement Systems

Activity	Schedule
<ul style="list-style-type: none"> • Vacuum sweep permeable pavement surface to keep the surface free of sediment. 	Quarterly
<ul style="list-style-type: none"> • Inspect permeable pavement system for drawdown following rainfall events. Failure to drawdown within 72 hours after the end of a rainfall event may indicate permeable pavement system failure. • Inspect permeable pavement surface for deterioration or spalling. Repair or replace any damaged areas as needed. 	Annually
<ul style="list-style-type: none"> • Rehabilitate the permeable pavement system, including the surface course and stone reservoir. 	Upon System Failure

Additional Resources

Hunt, W. and K. Collins. 2008. "Permeable Pavement: Research Update and Design Implications." *North Carolina Cooperative Extension Service Bulletin*. Urban Waterways Series. AG-588-14. North Carolina State University. Raleigh, NC. Available Online: <http://www.bae.ncsu.edu/stormwater/PublicationFiles/PermPave2008.pdf>.

Atlanta Regional Commission (ARC). 2001. "Porous Concrete." *Georgia Stormwater Management Manual*. Volume 2. Technical Handbook. Section 3.3.7. Atlanta Regional Commission. Atlanta, GA. Available Online: <http://www.georgia-stormwater.com/>.

Atlanta Regional Commission (ARC). 2001. "Modular Porous Paver Systems." *Georgia Stormwater Management Manual*. Volume 2. Technical Handbook. Section 3.3.8. Atlanta Regional Commission. Atlanta, GA. Available Online: <http://www.georgiastormwater.com/>.

7.8.5 Undisturbed Pervious Areas

Description

Undisturbed pervious areas, including primary and secondary conservation areas (Section 7.6), can be used to “receive” the post-construction stormwater runoff generated elsewhere on a development site. If stormwater runoff can be evenly distributed over them as overland sheet flow, undisturbed pervious areas can provide significant reductions in post-construction stormwater runoff rates, volumes and pollutant loads on development sites. Consequently, they can be used to “receive” stormwater runoff on a development site and help satisfy the SWM Criteria presented in this CSS.



(Source: Center for Watershed Protection)

<p style="text-align: center;"><u>KEY CONSIDERATIONS</u></p> <p>DESIGN CRITERIA:</p> <ul style="list-style-type: none"> • Stormwater runoff should enter undisturbed pervious areas as overland sheet flow • Length of flow path in contributing drainage areas should be 150 feet or less in pervious drainage areas and 75 feet or less in impervious drainage areas • Length of flow path in undisturbed pervious areas used to “receive” post-construction stormwater runoff must be 50 feet or more <p>BENEFITS:</p> <ul style="list-style-type: none"> • Helps restore pre-development hydrology on development sites and reduces post-construction stormwater runoff rates, volumes and pollutant loads • Helps protect valuable aquatic and terrestrial resources from the direct impacts of the land development process <p>LIMITATIONS:</p> <ul style="list-style-type: none"> • Should be managed in a natural state and protected from future land disturbing activities by an acceptable conservation instrument 	<p style="text-align: center;"><u>STORMWATER MANAGEMENT “CREDITS”</u></p> <ul style="list-style-type: none"> <input checked="" type="checkbox"/> Runoff Reduction <input checked="" type="checkbox"/> Water Quality Protection <input checked="" type="checkbox"/> Aquatic Resource Protection <input checked="" type="checkbox"/> Overbank Flood Protection <input checked="" type="checkbox"/> Extreme Flood Protection <p><input checked="" type="checkbox"/> = practice has been assigned quantifiable stormwater management “credits” that can be used to address this SWM Criteria</p>						
<p style="text-align: center;"><u>SITE APPLICABILITY</u></p> <table border="0"> <tr> <td><input checked="" type="checkbox"/> Rural Use</td> <td><input type="checkbox"/> Construction Cost</td> </tr> <tr> <td><input checked="" type="checkbox"/> Suburban Use</td> <td><input type="checkbox"/> Maintenance</td> </tr> <tr> <td>Urban Use</td> <td><input type="checkbox"/> Area Required</td> </tr> </table>	<input checked="" type="checkbox"/> Rural Use	<input type="checkbox"/> Construction Cost	<input checked="" type="checkbox"/> Suburban Use	<input type="checkbox"/> Maintenance	Urban Use	<input type="checkbox"/> Area Required	<p style="text-align: center;"><u>STORMWATER MANAGEMENT PRACTICE PERFORMANCE</u></p> <p>Runoff Reduction 50%-75% - Annual Runoff Volume 60%-90% - Runoff Reduction Volume</p> <p>Pollutant Removal¹ 80% - Total Suspended Solids 50% - Total Phosphorus 50% - Total Nitrogen N/A - Metals N/A - Pathogens</p> <p>1 = expected annual pollutant load removal</p>
<input checked="" type="checkbox"/> Rural Use	<input type="checkbox"/> Construction Cost						
<input checked="" type="checkbox"/> Suburban Use	<input type="checkbox"/> Maintenance						
Urban Use	<input type="checkbox"/> Area Required						

Discussion

Undisturbed pervious areas, including primary and secondary conservation areas (Section 7.6), can be used to “receive” the post-construction stormwater runoff generated elsewhere on a development site. The native vegetation found in these undisturbed pervious areas increases evaporation and transpiration rates, slows and filters stormwater runoff and helps improve soil porosity and soil infiltration rates. If stormwater runoff can be evenly distributed over them as overland sheet flow, undisturbed pervious areas can provide significant reductions in post-construction stormwater runoff rates, volumes and pollutant loads on development sites. Consequently, they can be used to “receive” stormwater runoff on a development site and help satisfy the SWM Criteria presented in this CSS.

If concentrated stormwater runoff is allowed to enter an undisturbed pervious area, it can cause soil erosion and can significantly reduce the stormwater management benefits that the undisturbed pervious area provides. Consequently, stormwater runoff needs to be intercepted and distributed evenly, as overland sheet flow, across an undisturbed pervious area that will be used to “receive” post-construction stormwater runoff. This can be accomplished by limiting the length of the flow path within the contributing drainage area and by using a level spreader at the upstream end of the undisturbed pervious area that will “receive” post-construction stormwater runoff (Figure 7.30).

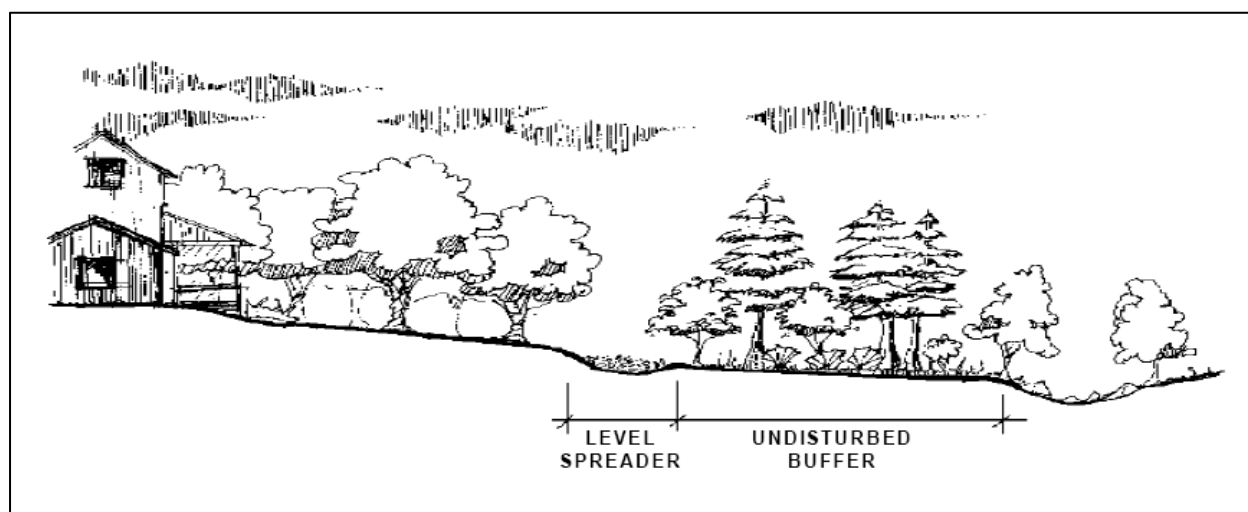

Figure 7.30: Use of a Level Spreader Upstream of an Undisturbed Pervious Area

(Source: North Carolina Department of Environment and Natural Resources, 1998)

Since the undisturbed pervious areas that are used to “receive” stormwater runoff on a development site are typically designed to be on-line stormwater management practices, consideration should be given to the stormwater runoff rates and volumes generated by larger storm events (e.g., 25-year, 24-hour storm event) to help ensure that they do not cause significant damage within the undisturbed pervious areas.

Stormwater Management “Credits”

The Center for Watershed Protection (Hirschman et al., 2008) recently documented the ability of undisturbed pervious areas that “receive” stormwater runoff to reduce annual stormwater runoff volumes and pollutant loads on development sites. Consequently, this low impact development practice has been assigned quantifiable stormwater management “credits” that can be used to help satisfy the SWM Criteria presented in this CSS:

- **Stormwater Runoff Reduction:** Reduce the runoff reduction volume (RR_v) conveyed through an *undisturbed pervious area* located on A/B soils by 90%. Reduce the runoff reduction volume (RR_v) conveyed through an *undisturbed pervious area* located on C/D soils by 60%.
- **Water Quality Protection:** Reduce the runoff reduction volume (RR_v) conveyed through an *undisturbed pervious area* located on A/B soils by 90%. Reduce the runoff reduction volume (RR_v) conveyed through an *undisturbed pervious area* located on C/D soils by 60%.
- **Aquatic Resource Protection:** Proportionally adjust the post-development runoff curve number (CN) to account for the runoff reduction provided by an *undisturbed pervious area* when calculating the aquatic resource protection volume (ARP_v) on a development site.
- **Overbank Flood Protection:** Proportionally adjust the post-development runoff curve number (CN) to account for the runoff reduction provided by an *undisturbed pervious area* when calculating the overbank peak discharge (Q_{p25}) on a development site.
- **Extreme Flood Protection:** Proportionally adjust the post-development runoff curve number (CN) to account for the runoff reduction provided by an *undisturbed pervious area* when calculating the extreme peak discharge (Q_{p100}) on a development site.

In order to “receive” stormwater runoff and be eligible for these “credits,” it is *recommended* that undisturbed pervious areas used to “receive” post-construction stormwater runoff satisfy the planning and design criteria outlined below.

Overall Feasibility

The criteria listed in Table 7.15 should be evaluated to determine whether or not an undisturbed pervious area should be used to “receive” stormwater runoff on a development site.

Table 7.15: Factors to Consider When Evaluating the Overall Feasibility of Using Undisturbed Pervious Areas to “Receive” Stormwater Runoff on a Development Site	
Site Characteristic	Criteria
Drainage Area	The length of flow path in the contributing drainage area should be 150 feet or less in pervious drainage areas and 75 feet or less in impervious drainage areas.
Area Required	The length of the flow path in the undisturbed pervious area used to “receive” post-construction stormwater runoff should be 50 feet or more.
Slope	Maximum 3% in contributing drainage area, unless terracing or level spreaders are used at 20 foot intervals along the length of the flow path to slow and redistribute stormwater runoff as overland sheet flow. Minimum 0.5% and maximum 6% in the undisturbed pervious area used to “receive” post-construction stormwater runoff.
Minimum Head	N/A
Minimum Depth to Water Table	No restrictions
Soils	No restrictions, although undisturbed pervious areas located on permeable soils (i.e., hydrologic soil group A or B soils) provide greater stormwater management benefits.

Site Applicability

Although it may be difficult to use undisturbed pervious areas to “receive” stormwater runoff in urban areas, due to space constraints, undisturbed pervious areas can be used to “receive” stormwater runoff on a wide variety of development sites, including residential, commercial, industrial and institutional development sites in rural and suburban areas. When compared with other low impact development practices, undisturbed pervious areas have a relatively low construction cost, a relatively low maintenance burden and require a relatively large amount of surface area.

Planning and Design Criteria

It is *recommended* that the undisturbed pervious areas used to “receive” stormwater runoff on a development site meet all of the following criteria to be eligible for the stormwater management “credits” described above:

General Planning and Design

- The following primary and secondary conservation areas should not be used to “receive” post-construction stormwater runoff on a development site:
 - Rivers
 - Perennial and Intermittent Streams
 - Freshwater Wetlands
 - Tidal Rivers and Streams
 - Tidal Creeks
 - Coastal Marshlands
 - Tidal Flats
 - Scrub-Shrub Wetlands
 - Near Coastal Waters
 - Beaches
 - Shellfishing Areas
 - Erodible Soils
 - Steep Slopes (i.e., Areas with Slopes Greater Than 15%)
- Although the primary and secondary conservation areas listed above can not be used to “receive” post-construction stormwater runoff on a development site, other undisturbed pervious areas, including aquatic buffers, floodplains, stands of trees and other existing vegetation, and areas preserved through the use of reduced clearing and grading (Section 7.7.1), may be used to help reduce post-construction stormwater runoff rates, volumes and pollutant loads.
- The length of the flow path within the contributing drainage area should be 150 feet or less for pervious drainage areas and 75 feet or less for impervious drainage areas.
- The average slope of the contributing drainage area should be 3% or less, unless terracing or level spreaders are used at 20 foot intervals along the length of the flow path to slow and redistribute stormwater runoff as overland sheet flow.
- In order to use undisturbed pervious areas as “receiving” low impact development practices, stormwater runoff needs to be conveyed into them as overland sheet flow. A level spreader should be used at the upstream end of the undisturbed pervious area to ensure that stormwater runoff enters it as overland sheet flow.
- A pea gravel diaphragm makes an effective level spreader at the upstream end of undisturbed pervious areas used to “receive” stormwater runoff. A pea gravel diaphragm, which is a small trench filled with pea gravel (i.e., ASTM D 448 Size No. 8, 3/8” to 1/8”), intercepts stormwater runoff and distributes it evenly, as overland sheet flow, across an undisturbed pervious area. Other types of level spreaders that can be used to redistribute stormwater runoff at the upstream end of undisturbed pervious areas include concrete sills, curb stops and curbs with “sawteeth” cut into them.

- The length of the flow path within the undisturbed pervious area used to “receive” post-construction stormwater runoff should be 50 feet or more.
- The average slope of the undisturbed pervious area used to “receive” post-construction stormwater runoff should be 6% or less. Greater slopes would encourage the formation of concentrated flow, which would cause soil erosion and significantly reduce the stormwater management benefits that undisturbed pervious areas provide.
- Consideration should be given to the stormwater runoff rates and volumes generated by larger storm events (e.g., 25-year, 24-hour storm event) to help ensure that these larger storm events do not cause significant damage to the undisturbed pervious areas. If necessary, a bypass channel or overflow spillway may be used to manage the stormwater runoff generated by these larger storm events.
- Undisturbed pervious areas should not be used to “receive” post-construction stormwater runoff from stormwater hotspots, unless adequate pretreatment is provided upstream of them.
- Undisturbed pervious areas used to “receive” stormwater runoff should not be disturbed before, during or after construction (except for temporary disturbances associated with incidental utility construction, restoration activities, or removal of invasive vegetation).

Landscaping

- A long-term vegetation management plan should be developed for all undisturbed pervious areas used to “receive” post-construction stormwater runoff. The plan should clearly specify how the area will be maintained in an undisturbed, natural state over time. Turf management is *not* considered to be an acceptable form of vegetation management. Consequently, only undisturbed pervious areas that remain in an undisturbed, natural state are eligible for the stormwater management “credits” described above. Vegetated filter strips (Section 7.8.6) may be used to “receive” post-construction stormwater runoff in areas that have been disturbed by clearing, grading and other land disturbing activities.

Construction Considerations

To help ensure that undisturbed pervious areas are properly used to “receive” stormwater runoff on a development site, site planning and design teams should consider the following recommendations:

- To help prevent soil compaction, heavy vehicular and foot traffic should be kept out of all undisturbed pervious areas used to “receive” post-construction stormwater runoff before, during and after construction. This can typically be accomplished by clearly delineating “receiving” undisturbed pervious areas on all development plans and protecting them with temporary fencing prior to the start of land disturbing activities.

Maintenance Requirements

Undisturbed pervious areas used to “receive” post-construction stormwater runoff typically require very little long-term maintenance, but a legally binding inspection and maintenance agreement and plan should be created to help ensure that they are properly maintained after construction is complete. Table 7.16 provides a list of the routine maintenance activities typically associated with undisturbed pervious areas used to “receive” post-construction stormwater runoff.

Table 7.16: Routine Maintenance Activities Typically Associated with Undisturbed Pervious Areas Used to "Receive" Stormwater Runoff

Activity	Schedule
<ul style="list-style-type: none"> • Inspect level spreader for clogging and sediment accumulation. Remove any accumulated sediment or debris. • Inspect undisturbed natural area for erosion. Plant replacement vegetation in any eroded areas. • Inspect undisturbed natural area for dead or dying vegetation. Plant replacement vegetation as needed. 	Annually (Semi-Annually During First Year)

Additional Resources

Minnesota Pollution Control Agency (MPCA). 2006. "Credit 3: Drainage to Stream, Wetland or Shoreline Buffer Credit." *Minnesota Stormwater Manual*. Section 11.3.2. Minnesota Pollution Control Agency. Available Online: <http://www.pca.state.mn.us/water/stormwater/stormwater-manual.html>.

Atlanta Regional Commission (ARC). 2001. "Site Design Credit #2: Stream Buffers." *Georgia Stormwater Management Manual*. Volume 2. Technical Handbook. Section 1.4.4.4. Atlanta Regional Commission. Atlanta, GA. Available Online: <http://www.georgiastormwater.com/>.

7.8.6 Vegetated Filter Strips

Description

Vegetated filter strips are uniformly graded, densely vegetated areas of land designed to slow and filter stormwater runoff. They are typically installed in areas that have been disturbed by clearing, grading and other land disturbing activities and are typically vegetated with managed turf. If stormwater runoff can be evenly distributed over them as overland sheet flow, vegetated filter strips can provide significant reductions in post-construction stormwater runoff rates, volumes and pollutant loads on development sites. Consequently, vegetated filter strips can be used to help satisfy the SWM Criteria presented in this CSS.



(Source: Merrill et al., 2006)

<p style="text-align: center;"><u>KEY CONSIDERATIONS</u></p> <p>DESIGN CRITERIA:</p> <ul style="list-style-type: none"> • Stormwater runoff should enter vegetated filter strips as overland sheet flow • Length of flow path in contributing drainage areas should be 150 feet or less in pervious drainage areas and 75 feet or less in impervious drainage areas • Length of flow path in vegetated filter strip should be 25 feet or more • Vegetated filter strips should have a slope of at least 0.5% to ensure adequate drainage <p>BENEFITS:</p> <ul style="list-style-type: none"> • Helps restore pre-development hydrology on development sites and reduces post-construction stormwater runoff rates, volumes and pollutant loads • Relatively low construction cost and long-term maintenance burden <p>LIMITATIONS:</p> <ul style="list-style-type: none"> • Can be difficult to maintain overland sheet flow within a vegetated filter strip, which needs to be provided to prevent soil erosion and ensure practice performance 	<p style="text-align: center;"><u>STORMWATER MANAGEMENT "CREDITS"</u></p> <ul style="list-style-type: none"> <input checked="" type="checkbox"/> Runoff Reduction <input checked="" type="checkbox"/> Water Quality Protection <input checked="" type="checkbox"/> Aquatic Resource Protection <input checked="" type="checkbox"/> Overbank Flood Protection <input checked="" type="checkbox"/> Extreme Flood Protection <p><input checked="" type="checkbox"/> = practice has been assigned quantifiable stormwater management "credits" that can be used to address this SWM Criteria</p>						
<p style="text-align: center;"><u>SITE APPLICABILITY</u></p> <table border="0"> <tr> <td><input checked="" type="checkbox"/> Rural Use</td> <td><input type="checkbox"/> Construction Cost</td> </tr> <tr> <td><input checked="" type="checkbox"/> Suburban Use</td> <td><input type="checkbox"/> Maintenance</td> </tr> <tr> <td><input checked="" type="checkbox"/> Urban Use</td> <td><input type="checkbox"/> Area Required</td> </tr> </table>	<input checked="" type="checkbox"/> Rural Use	<input type="checkbox"/> Construction Cost	<input checked="" type="checkbox"/> Suburban Use	<input type="checkbox"/> Maintenance	<input checked="" type="checkbox"/> Urban Use	<input type="checkbox"/> Area Required	<p style="text-align: center;"><u>STORMWATER MANAGEMENT PRACTICE PERFORMANCE</u></p> <p>Runoff Reduction 25%-50% - Annual Runoff Volume 30%-60% - Runoff Reduction Volume</p> <p>Pollutant Removal¹ 80% - Total Suspended Solids 25% - Total Phosphorus 25% - Total Nitrogen 40% - Metals N/A - Pathogens</p> <p>¹ = expected annual pollutant load removal</p>
<input checked="" type="checkbox"/> Rural Use	<input type="checkbox"/> Construction Cost						
<input checked="" type="checkbox"/> Suburban Use	<input type="checkbox"/> Maintenance						
<input checked="" type="checkbox"/> Urban Use	<input type="checkbox"/> Area Required						

Discussion

Vegetated filter strips (also known as *filter strips*, *vegetated filters* or *grass filters*) are uniformly graded, densely vegetated areas of land designed to slow and filter stormwater runoff. They are typically installed in areas that have been disturbed by clearing, grading and other land disturbing activities and are typically vegetated with managed turf. If stormwater runoff can be evenly distributed over them as overland sheet flow, they can provide significant reductions in post-construction stormwater runoff rates, volumes and pollutant loads on development sites, particularly when they are located on areas with permeable soils (i.e., hydrologic soil group A and B soils).

Vegetated filter strips can be attractively integrated into development sites as landscaping features and are well suited to “receive” stormwater runoff from local streets and roadways, highways, roof downspouts, small parking lots and disturbed pervious surfaces (e.g., lawns, parks, community open spaces). They are particularly well suited for use in the “outer zone” of aquatic buffers (Box 4.3), in the landscaped areas commonly found between adjoining properties (e.g., setbacks) and incompatible land uses (e.g., residential and commercial land uses) and around the perimeter of parking lots (Figure 7.31). They can also be used to pretreat stormwater runoff before it enters other low impact development practices, such as undisturbed pervious areas (Section 7.8.5), bioretention areas (Section 7.8.13) and infiltration practices (Section 7.8.14), which increases the reductions in stormwater runoff rates, volumes and pollutant loads that these other low impact development practices provide.



Figure 7.31: Filter Strip Around the Perimeter of a Parking Lot

(Source: Atlanta Regional Commission, 2001)

If concentrated stormwater runoff is allowed to enter a vegetated filter strip, it can cause soil erosion and can significantly reduce the stormwater management benefits that the filter strip provides. Consequently, stormwater runoff needs to be intercepted and distributed evenly, as overland sheet flow, across a vegetated filter strip. This can be accomplished by limiting the length of the flow path within the contributing drainage area and by using a level spreader at the upstream end of the vegetated filter strip that will “receive” post-construction stormwater runoff (Figure 7.32).

There are two different filter strip designs that can be used on a development site. The first is a simple design, while the second is more advanced, and includes a permeable berm at the downstream end of the filter strip (Figure 7.32). The permeable berm is used to temporarily store stormwater runoff within the filter strip, which increases the residence time that it provides and reduces the required width of the filter strip.

Since the vegetated filter strips that are used to “receive” stormwater runoff on a development site are typically designed to be on-line stormwater management practices, consideration should be given to the stormwater runoff rates and volumes generated by larger storm events (e.g., 25-year, 24-hour storm event) to help ensure that they do not cause significant damage to a vegetated filter strip.

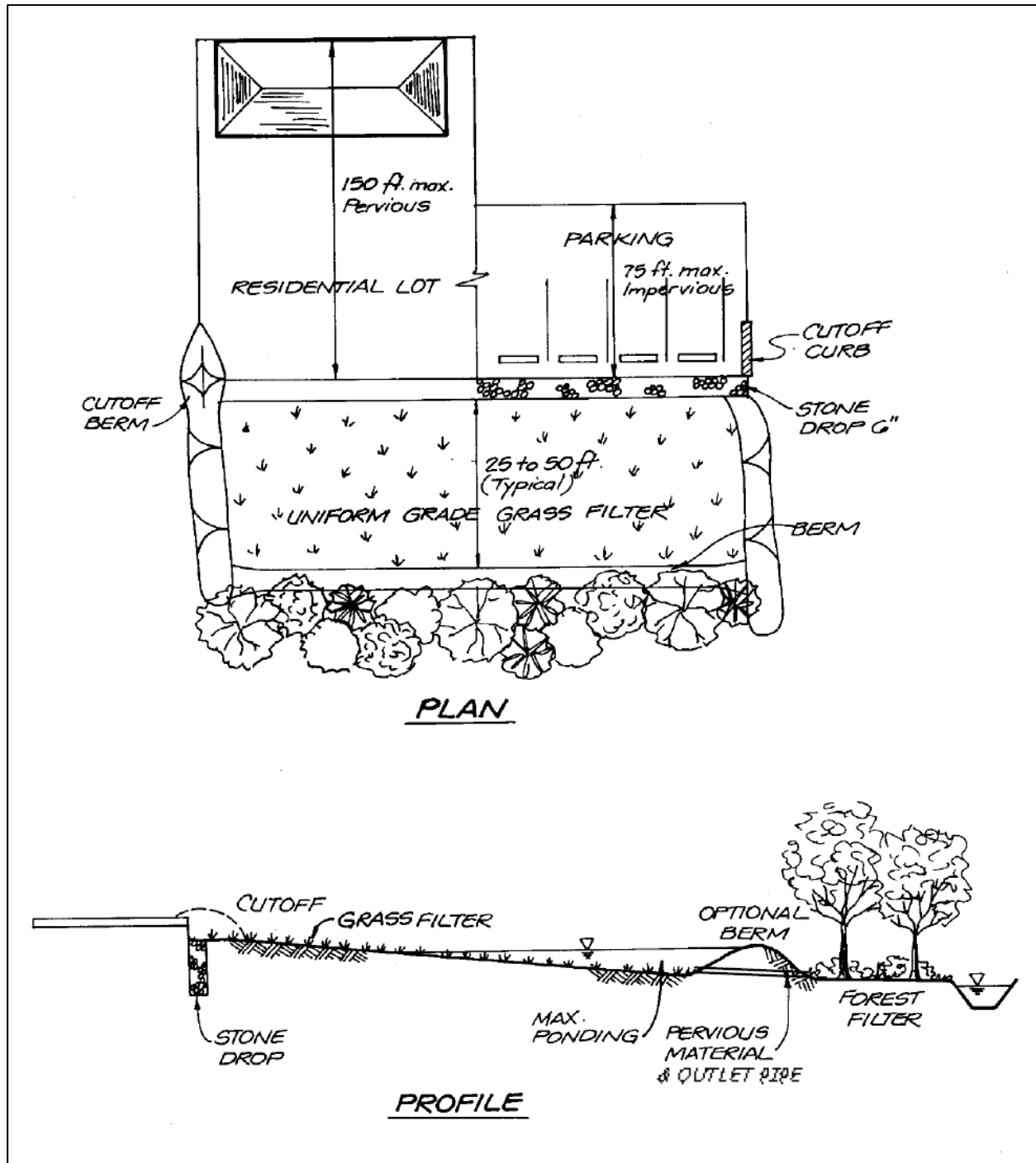

Figure 7.32: Vegetated Filter Strip
 (Source: Atlanta Regional Commission, 2001)

Stormwater Management "Credits"

The Center for Watershed Protection (Hirschman et al., 2008) recently documented the ability of vegetated filter strips to reduce annual stormwater runoff volumes and pollutant loads on development sites. Consequently, this low impact development practice has been assigned quantifiable stormwater management "credits" that can be used to help satisfy the SWM Criteria presented in this CSS:

- **Stormwater Runoff Reduction:** Reduce the runoff reduction volume (RR_v) conveyed through a *vegetated filter strip* located on A/B or amended soils by 60%. Reduce the runoff reduction volume (RR_v) conveyed through a *vegetated filter strip* located on C/D soils by 30%.
- **Water Quality Protection:** Reduce the runoff reduction volume (RR_v) conveyed through a *vegetated filter strip* located on A/B or amended soils by 60%. Reduce the runoff reduction volume (RR_v) conveyed through a *vegetated filter strip* located on C/D soils by 30%.
- **Aquatic Resource Protection:** Proportionally adjust the post-development runoff curve number (CN) to account for the runoff reduction provided by a *vegetated filter strip* when calculating the aquatic resource protection volume (ARP_v) on a development site.
- **Overbank Flood Protection:** Proportionally adjust the post-development runoff curve number (CN) to account for the runoff reduction provided by a *vegetated filter strip* when calculating the overbank peak discharge (Q_{p25}) on a development site.
- **Extreme Flood Protection:** Proportionally adjust the post-development runoff curve number (CN) to account for the runoff reduction provided by a *vegetated filter strip* when calculating the extreme peak discharge (Q_{p100}) on a development site.

In order to “receive” stormwater runoff and be eligible for these “credits,” it is *recommended* that vegetated filter strips satisfy the planning and design criteria outlined below.

Overall Feasibility

The criteria listed in Table 7.17 should be evaluated to determine whether or not a vegetated filter strip should be used to “receive” stormwater runoff on a development site.

Table 7.17: Factors to Consider When Evaluating the Overall Feasibility of Using a Vegetated Filter Strip on a Development Site	
Site Characteristic	Criteria
Drainage Area	The length of flow path in the contributing drainage area should be 150 feet or less in pervious drainage areas and 75 feet or less in impervious drainage areas.
Area Required	Unless a permeable berm is provided, the length of the flow path in the vegetated filter strip used to “receive” stormwater runoff should be 25 feet or more. If a permeable berm is provided, the length of the flow path in the vegetated filter strip used to “receive” stormwater runoff should be 15 feet or more.
Slope	Maximum 3% in contributing drainage area, unless terracing or level spreaders are used at 20 foot intervals along the length of the flow path to slow and redistribute stormwater runoff as overland sheet flow. Minimum 0.5% and maximum 6% in the vegetated filter strip used to “receive” post-construction stormwater runoff.
Minimum Head	N/A
Minimum Depth to Water Table	No restrictions
Soils	No restrictions, although vegetated filter strips located on permeable soils (i.e., hydrologic soil group A or B soils) provide greater stormwater management benefits.

Feasibility in Coastal Georgia

Several site characteristics commonly encountered in coastal Georgia may present challenges to site planning and design teams that are interested in using vegetated filter strips to “receive” post-construction stormwater runoff on a development site. Table 7.18 identifies these common site characteristics and describes how they influence the use of vegetated filter strips on development sites. The table also provides site planning and design teams with some ideas about how they can work around these potential constraints.

Table 7.18: Challenges Associated with Using Vegetated Filter Strips in Coastal Georgia		
Site Characteristic	How it Influences the Use of Vegetated Filter Strips	Potential Solutions
<ul style="list-style-type: none"> • <i>Poorly drained soils, such as hydrologic soil group C and D soils</i> 	<ul style="list-style-type: none"> • Reduces the ability of vegetated filter strips to reduce stormwater runoff rates, volumes and pollutant loads. 	<ul style="list-style-type: none"> • Use soil restoration (Section 7.8.1) to improve soil porosity and the ability of vegetated filter strips to reduce stormwater runoff rates, volumes and pollutant loads. • Place buildings and other impervious surfaces on poorly drained soils or preserve them as secondary conservation areas (Section 7.6.2). • Use additional low impact development practices to supplement the stormwater management benefits provided by vegetated filter strips.
<ul style="list-style-type: none"> • <i>Well drained soils, such as hydrologic soil group A and B soils</i> 	<ul style="list-style-type: none"> • Enhances the ability of vegetated filter strips to reduce stormwater runoff rates, volumes and pollutant loads, but may allow stormwater pollutants to reach groundwater aquifers with greater ease. 	<ul style="list-style-type: none"> • Avoid the use of infiltration-based low impact development practices, including vegetated filter strips, at stormwater hotspots and in areas known to provide groundwater recharge to water supply aquifers, unless adequate pretreatment is provided upstream of them.
<ul style="list-style-type: none"> • <i>Flat terrain</i> 	<ul style="list-style-type: none"> • May be difficult to provide adequate drainage and may cause stormwater runoff to pond on the surface of a vegetated filter strip. 	<ul style="list-style-type: none"> • Design vegetated filter strips with a slope of at least 0.5% to help ensure adequate drainage. • Where soils are well drained, use non-underdrained bioretention areas (Section 7.8.13) and infiltration practices (Section 7.8.14), to reduce stormwater runoff rates, volumes and pollutant loads and prevent ponding in these areas. • Where soils are poorly drained, use small stormwater wetlands (i.e., pocket wetlands) (Section 8.6.2) to intercept and treat stormwater runoff.

Table 7.18: Challenges Associated with Using Vegetated Filter Strips in Coastal Georgia

Site Characteristic	How it Influences the Use of Vegetated Filter Strips	Potential Solutions
<ul style="list-style-type: none"> <i>Shallow water table</i> 	<ul style="list-style-type: none"> May occasionally cause stormwater runoff to pond on the surface of a vegetated filter strip. 	<ul style="list-style-type: none"> Use small stormwater wetlands (i.e., pocket wetlands) (Section 8.6.2) or wet swales (Section 8.6.6) to intercept and treat stormwater runoff in these areas.
<ul style="list-style-type: none"> <i>Tidally-influenced drainage system</i> 	<ul style="list-style-type: none"> May occasionally prevent stormwater runoff from being conveyed through a vegetated filter strip, particularly during high tide. 	<ul style="list-style-type: none"> Investigate the use of other low impact development practices, such as rainwater harvesting (Section 7.8.12) to “receive” stormwater runoff in these areas.

Site Applicability

Although it may be difficult to use them to “receive” stormwater runoff in urban areas, due to space constraints, vegetated filter strips can be used to “receive” stormwater runoff on a wide variety of development sites, including residential, commercial, industrial and institutional development sites in rural and suburban areas. When compared with other low impact development practices, vegetated filter strips have a relatively low construction cost, a relatively low maintenance burden and require a relatively large amount of surface area.

Planning and Design Criteria

It is *recommended* that the vegetated filter strips used to “receive” stormwater runoff on a development site meet all of the following criteria to be eligible for the stormwater management “credits” described above:

General Planning and Design

- The length of the flow path within the contributing drainage area should be 150 feet or less for pervious drainage areas and 75 feet or less for impervious drainage areas. In contributing drainage areas with longer flow paths, stormwater runoff tends to become shallow, concentrated flow (Clayton and Schueler, 1996), which can cause soil erosion and can significantly reduce the stormwater management benefits that vegetated filter strips provide. In these situations, grass channels (Section 7.8.7) or swales (Section 8.6.6) should be used to “receive” post-construction stormwater runoff instead of vegetated filter strips (Lantin and Barrett, 2005).
- The average slope of the contributing drainage area should be 3% or less, unless terracing or level spreaders are used at 20 foot intervals along the length of the flow path to slow and redistribute stormwater runoff as overland sheet flow.
- In order to use vegetated filter strips as “receiving” low impact development practices, stormwater runoff needs to be conveyed into them as overland sheet flow. A level spreader should be used at the upstream end of the filter strip to ensure that stormwater runoff enters it as overland sheet flow.
- A pea gravel diaphragm makes an effective level spreader at the upstream end of vegetated filter strips used to “receive” post-construction stormwater runoff. A pea gravel diaphragm, which is a small trench filled with pea gravel (i.e., ASTM D 448 Size No. 8, 3/8” to 1/8”), intercepts stormwater runoff and distributes it evenly, as overland sheet flow, across a filter strip. Other types of level spreaders that can be used to redistribute stormwater runoff at the upstream end of vegetated filter strips include concrete sills, curb stops and curbs with “sawteeth” cut into them.

- The average slope of the vegetated filter strip should be between 0.5% and 6%. Greater slopes would encourage the formation of shallow, concentrated flow within the filter strip, while lesser slopes would encourage ponding.
- The design procedures provided in Section 3.3.1 of Volume 2 of the *Georgia Stormwater Management Manual* (ARC, 2001) should be used to determine the length of the flow path required within a vegetated filter strip. However, to provide adequate residence time for stormwater runoff, the length of the flow path within a vegetated filter strip should be no less than 25 feet. The length of the flow path within a vegetated filter strip designed with permeable berm may be shorter, but should be no less than 15 feet long.
- Permeable berms should be constructed using hydrologic soil group A and B soils (i.e., sands, gravels, sandy loams) that will support plant growth.
- The maximum ponding depth behind a permeable berm should be 12 inches or less.
- Appropriately sized outlets (Figure 7.32) should be provided within permeable berms to ensure that vegetated filter strips will drain within 24 hours following the end of a rainfall event.
- Consideration should be given to the stormwater runoff rates and volumes generated by larger storm events (e.g., 25-year, 24-hour storm event) to help ensure that these larger storm events do not cause significant damage to vegetated filter strips. If necessary, a bypass channel or overflow spillway may be used to manage the stormwater runoff generated by these larger storm events.
- Vegetated filter strips should not be used to “receive” stormwater runoff from stormwater hotspots, unless adequate pretreatment is provided upstream of them.

Landscaping

- A landscaping plan should be prepared for all vegetated filter strips. The landscaping plan should be reviewed and approved by the local development review authority prior to construction.
- Vegetation commonly planted on vegetated filter strips includes turf, shrubs, trees and other herbaceous vegetation. Although managed turf is most commonly used, site planning and design teams are encouraged to use trees, shrubs and/or other native vegetation to help establish mature native plant communities within vegetated filter strips.
- When developing a landscaping plan, site planning and design teams should choose grasses and other vegetation that will be able to tolerate the stormwater runoff rates and volumes that will pass through the vegetated filter strip. Vegetation used in vegetated filter strips should also be able to tolerate both wet and dry conditions. See Appendix F of Volume 2 of the *Georgia Stormwater Management Manual* (ARC, 2001) for a list of grasses and other plants that are appropriate for use in vegetated filter strips installed the state of Georgia.
- Methods used to establish vegetative cover within a vegetated filter strip should achieve at least 75 percent vegetative cover one year after installation.
- To help prevent soil erosion and sediment loss, landscaping should be provided immediately after the vegetated filter strip has been installed. Temporary irrigation may be needed to quickly establish vegetative cover on a vegetated filter strip.

Construction Considerations

To help ensure that vegetated filter strips are successfully installed on a development site, site planning and design teams should consider the following recommendations:

- Vegetated filter strips should be installed only after their contributing drainage areas have been completely stabilized.

- Simple erosion and sediment control measures, such as temporary seeding and erosion control mats, should be used on vegetated filter strips. Appropriate measures should be taken (e.g., silt fence, temporary diversion berm) to pretreat and/or divert post-construction stormwater runoff around a vegetated filter strip until vegetative cover has been established.
- To help prevent soil compaction, heavy vehicular and foot traffic should be kept out of vegetated filter strips during and after construction.
- Construction contracts should contain a replacement warranty that covers at least three growing seasons to help ensure adequate growth and survival of the vegetation planted within a vegetated filter strip.

Maintenance Requirements

Maintenance is very important for vegetated filter strips, particularly in terms of ensuring that they continue to provide measurable stormwater management benefits over time. Consequently, a legally binding inspection and maintenance agreement and plan should be created to help ensure that they are properly maintained after construction is complete. Table 7.19 provides a list of the routine maintenance activities typically associated with vegetated filter strips. It is important to note that vegetated filter strips have maintenance requirements that are very similar to those of other vegetated low impact development practices.

Activity	Schedule
<ul style="list-style-type: none"> • Water to promote plant growth and survival. • Inspect vegetated filter strip following rainfall events. Plant replacement vegetation in any eroded areas. 	As Needed (Following Construction)
<ul style="list-style-type: none"> • Inspect vegetated filter strip. Maintain vegetation (e.g., mow, prune, trim) as needed. • Remove accumulated trash and debris. 	Regularly (Monthly)
<ul style="list-style-type: none"> • Inspect level spreader for clogging and sediment accumulation. Remove any accumulated sediment or debris. • Inspect vegetated filter strip for erosion. Plant replacement vegetation in any eroded areas. • Inspect vegetated filter strip for dead or dying vegetation. Plant replacement vegetation as needed. 	Annually (Semi-Annually During First Year)

Additional Resources

Claytor, R. and T. Schueler. 1996. *Design of Stormwater Filtering Systems*. Prepared for: Chesapeake Research Consortium, Inc. Center for Watershed Protection. Ellicott City, MD. Available Online: http://www.cwp.org/Resource_Library/Controlling_Runoff_and_Discharges/sm.htm.

Minnesota Pollution Control Agency (MPCA). 2006. "Credit 4: Surface Impervious Cover Disconnection Credit." *Minnesota Stormwater Manual*. Section 11.3.2. Minnesota Pollution Control Agency. Available Online: <http://www.pca.state.mn.us/water/stormwater/stormwater-manual.html>.

Atlanta Regional Commission (ARC). 2001. "Filter Strip." *Georgia Stormwater Management Manual*. Volume 2. Technical Handbook. Section 3.3.1. Atlanta Regional Commission. Atlanta, GA. Available Online: <http://www.georgia-stormwater.com/>.

7.8.7 Grass Channels

Description

Where site characteristics permit, grass channels, which are densely vegetated stormwater conveyance features, can be used to “receive” and convey post-construction stormwater runoff. They are typically installed in areas that have been disturbed by clearing, grading and other land disturbing activities, and are typically vegetated with managed turf. If properly designed, grass channels can provide measurable reductions in post-construction stormwater runoff rates, volumes and pollutant loads. Consequently, they can be used to help satisfy the SWM Criteria presented in this CSS.



(Source: Center for Watershed Protection)

<p style="text-align: center;"><u>KEY CONSIDERATIONS</u></p> <p>DESIGN CRITERIA:</p> <ul style="list-style-type: none"> • Grass channels should be designed to accommodate the peak discharge generated by the target runoff reduction rainfall event (e.g., 85th percentile rainfall event) • Grass channels should be designed to be able to safely convey the overbank flood protection rainfall event (e.g., 25-year, 24-hour event) • Grass channels may be designed with a slope of between 0.5% and 3%, although a slope of between 1% and 2% is recommended <p>BENEFITS:</p> <ul style="list-style-type: none"> • Helps restore pre-development hydrology on development sites and reduces post-construction stormwater runoff rates, volumes and pollutant loads • Relatively low construction cost and long-term maintenance burden <p>LIMITATIONS:</p> <ul style="list-style-type: none"> • Should not be used on development sites with slopes of less than 0.5% • Provides greater stormwater management benefits on sites with permeable soils (i.e., hydrologic soil group A and B soils) 	<p style="text-align: center;"><u>STORMWATER MANAGEMENT “CREDITS”</u></p> <ul style="list-style-type: none"> <input checked="" type="checkbox"/> Runoff Reduction <input checked="" type="checkbox"/> Water Quality Protection <input checked="" type="checkbox"/> Aquatic Resource Protection <input checked="" type="checkbox"/> Overbank Flood Protection <input checked="" type="checkbox"/> Extreme Flood Protection <p><input checked="" type="checkbox"/> = practice has been assigned quantifiable stormwater management “credits” that can be used to address this SWM Criteria</p>						
<p style="text-align: center;"><u>SITE APPLICABILITY</u></p> <table border="0"> <tr> <td><input checked="" type="checkbox"/> Rural Use</td> <td><input type="checkbox"/> Construction Cost</td> </tr> <tr> <td><input checked="" type="checkbox"/> Suburban Use</td> <td><input type="checkbox"/> Maintenance</td> </tr> <tr> <td>Urban Use</td> <td><input type="checkbox"/> Area Required</td> </tr> </table>	<input checked="" type="checkbox"/> Rural Use	<input type="checkbox"/> Construction Cost	<input checked="" type="checkbox"/> Suburban Use	<input type="checkbox"/> Maintenance	Urban Use	<input type="checkbox"/> Area Required	<p style="text-align: center;"><u>STORMWATER MANAGEMENT PRACTICE PERFORMANCE</u></p> <p>Runoff Reduction 10%-20% - Annual Runoff Volume 12%-25% - Runoff Reduction Volume</p> <p>Pollutant Removal¹ 60% - Total Suspended Solids 25% - Total Phosphorus 30% - Total Nitrogen 30% - Metals N/A - Pathogens</p> <p>¹ = expected annual pollutant load removal</p>
<input checked="" type="checkbox"/> Rural Use	<input type="checkbox"/> Construction Cost						
<input checked="" type="checkbox"/> Suburban Use	<input type="checkbox"/> Maintenance						
Urban Use	<input type="checkbox"/> Area Required						

Discussion

Conventional storm drain systems are designed to quickly and efficiently convey stormwater runoff away from buildings, roadways and other impervious surfaces and into rivers, streams and other aquatic resources. When these conventional systems are used to “receive” and convey stormwater runoff on development sites, opportunities to reduce post-construction stormwater runoff rates, volumes and pollutant loads are lost. To take better advantage of these opportunities, grass channels can be used in place of conventional storm drain systems (e.g., curb and gutter systems, storm sewers, concrete channels) to “receive” and convey stormwater runoff.

Grass channels (also known as *vegetated open channels*) are densely vegetated stormwater conveyance features (Figure 7.33) designed to slow and filter stormwater runoff. They differ from the old, unvegetated roadside ditches of the past, which often suffered from erosion and standing water and occasionally worked to undermine the roadway itself. If grass channels are properly designed (e.g., sufficient channel widths, relatively flat slopes, dense vegetative cover), they can provide significant reductions in post-construction stormwater runoff rates, volumes and pollutant loads, particularly when they are located on areas with permeable soils (i.e., hydrologic soil group A and B soils).



**Figure 7.33: Grass Channel
Along a Local Roadway**
(Source: Atlanta Regional Commission, 2001)

Grass channels can be integrated into development sites as landscaping features and are well suited to “receive” stormwater runoff from local streets and roadways, highways, small parking lots and disturbed pervious surfaces (e.g., lawns, parks, community open spaces). They are typically installed in areas that have been disturbed by clearing, grading and other land disturbing activities and are particularly well suited for use in roadway rights-of-way (Figure 7.33). Grass channels are typically less expensive to install than conventional storm drain systems and can be used to pretreat stormwater runoff before it enters other low impact development practices, such as undisturbed pervious areas (Section 7.8.5), bioretention areas (Section 7.8.13) and infiltration practices (Section 7.8.14), which increases the reductions in stormwater runoff rates, volumes and pollutant loads that these other low impact development practices provide.

Two of the primary concerns associated with grass channels (Figure 7.34) are channel capacity and erosion control. In order to address these two concerns, site planning and design teams should work to ensure that the peak discharge rate generated by the target runoff reduction rainfall event (e.g., 85th percentile rainfall event) does not flow through the grass channel at a velocity greater than 1.0 foot per second (ft/s). Site planning and design teams should also work to ensure that grass channels provide at least 10 minutes of residence time for the peak discharge rate generated by the target runoff reduction rainfall event (Claytor and Schueler, 1996). Check dams can be placed across grass channels to help slow post-construction stormwater runoff and increase residence times.

Stormwater Management “Credits”

The Center for Watershed Protection (Hirschman et al., 2008) recently documented the ability of grass channels to reduce annual stormwater runoff volumes and pollutant loads on development sites. Consequently, this low impact development practice has been assigned

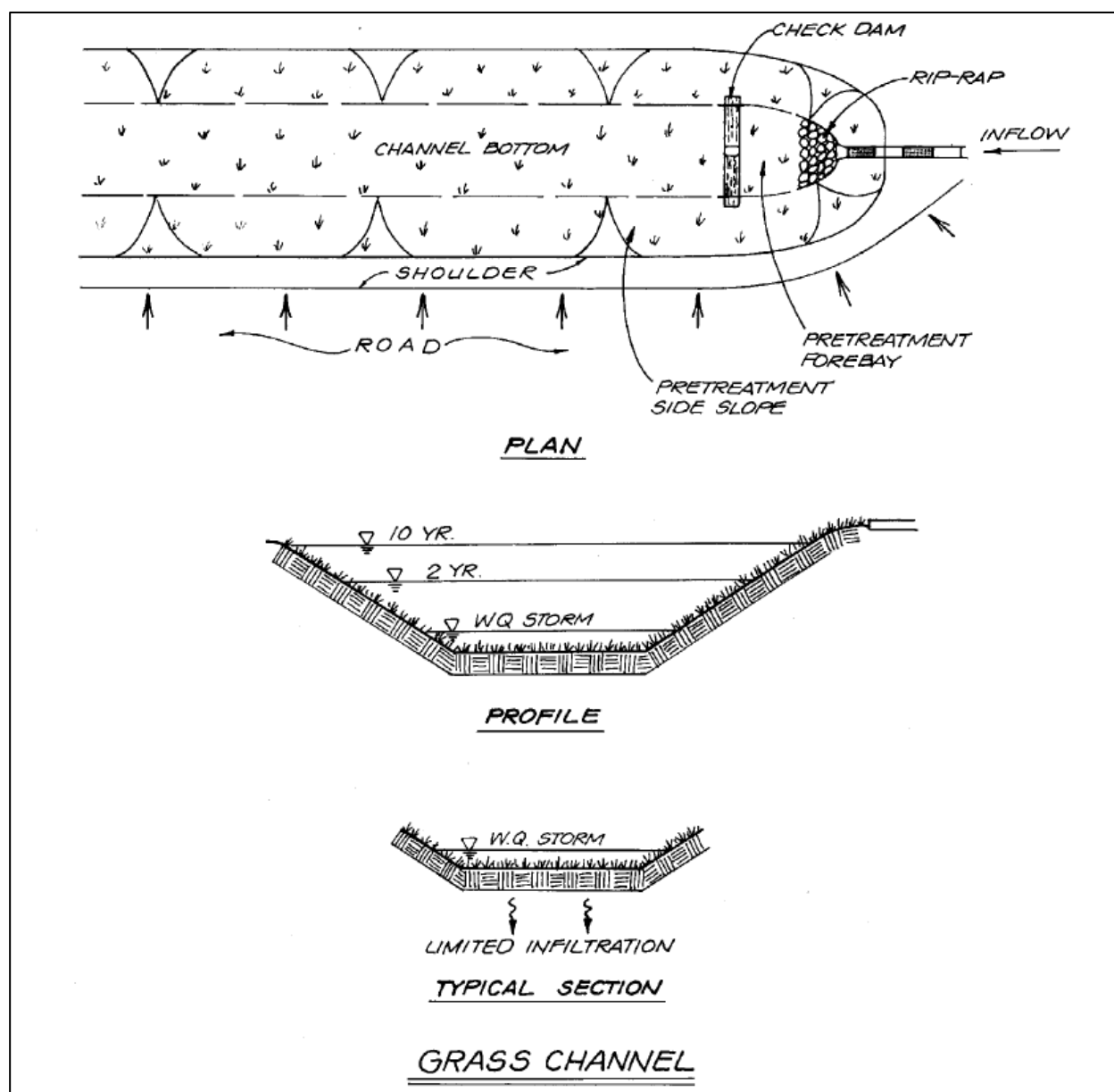

Figure 7.34: Grass Channel
 (Source: Atlanta Regional Commission, 2001)

quantifiable stormwater management “credits” that can be used to help satisfy the SWM Criteria presented in this CSS:

- **Stormwater Runoff Reduction:** Reduce the runoff reduction volume (RR_v) conveyed through a *grass channel* located on A/B or amended soils by 25%. Reduce the runoff reduction volume (RR_v) conveyed through a *grass channel* located on C/D soils by 12.5%.
- **Water Quality Protection:** Reduce the runoff reduction volume (RR_v) conveyed through a *grass channel* located on A/B or amended soils by 25%. Reduce the runoff reduction volume (RR_v) conveyed through a *grass channel* located on C/D soils by 12.5%.

- Aquatic Resource Protection: Proportionally adjust the post-development runoff curve number (CN) to account for the runoff reduction provided by a *grass channel* when calculating the aquatic resource protection volume (ARP_v) on a development site.
- Overbank Flood Protection: Proportionally adjust the post-development runoff curve number (CN) to account for the runoff reduction provided by a *grass channel* when calculating the overbank peak discharge (Q_{p25}) on a development site.
- Extreme Flood Protection: Proportionally adjust the post-development runoff curve number (CN) to account for the runoff reduction provided by a *grass channel* when calculating the extreme peak discharge (Q_{p100}) on a development site.

In order to “receive” stormwater runoff and be eligible for these “credits,” it is *recommended* that grass channels satisfy the planning and design criteria outlined below.

Overall Feasibility

The criteria listed in Table 7.20 should be evaluated to determine whether or not a grass channel should be used to “receive” stormwater runoff on a development site.

Table 7.20: Factors to Consider When Evaluating the Overall Feasibility of Using a Grass Channel on a Development Site	
Site Characteristic	Criteria
Drainage Area	The size of the contributing drainage area should be 5 acres or less.
Area Required	The bottom of a grass channel should be 2-8 feet wide. The side slopes of a grass channel should be 3:1(H:V) or flatter.
Slope	Although grass channels may be installed on development sites with slopes of between 0.5% and 3%, it is recommended that they be designed with slopes of between 1% and 2% to help ensure adequate drainage.
Minimum Head	N/A
Minimum Depth to Water Table	2 feet
Soils	No restrictions, although grass channels located on permeable soils (i.e., hydrologic soil group A or B soils) provide greater stormwater management benefits. Grass channels should generally not be located on soils with infiltration rates of less than 0.25 inches per hour (i.e., hydrologic soil group C and D soils) unless soil restoration (Section 7.8.1) is used to improve soil porosity and infiltration rates.

Feasibility in Coastal Georgia

Several site characteristics commonly encountered in coastal Georgia may present challenges to site planning and design teams that are interested in using grass channels to “receive” and convey post-construction stormwater runoff on a development site. Table 7.21 identifies these common site characteristics and describes how they influence the use of grass channels on development sites. The table also provides site planning and design teams with some ideas about how they can work around these potential constraints.

Table 7.21: Challenges Associated with Using Grass Channels in Coastal Georgia		
Site Characteristic	How it Influences the Use of Grass Channels	Potential Solutions
<ul style="list-style-type: none"> <i>Poorly drained soils, such as hydrologic soil group C and D soils</i> 	<ul style="list-style-type: none"> Reduces the ability of grass channels to reduce stormwater runoff rates, volumes and pollutant loads. 	<ul style="list-style-type: none"> Use soil restoration (Section 7.8.1) to improve soil porosity and the ability of grass channels to reduce stormwater runoff rates, volumes and pollutant loads. Use wet swales (i.e., linear wetland systems) (Section 8.6.6) to intercept, convey and treat stormwater runoff in these areas.
<ul style="list-style-type: none"> <i>Well drained soils, such as hydrologic soil group A and B soils</i> 	<ul style="list-style-type: none"> Enhances the ability of grass channels to reduce stormwater runoff rates, volumes and pollutant loads, but may allow stormwater pollutants to reach groundwater aquifers with greater ease. 	<ul style="list-style-type: none"> Avoid the use of infiltration-based low impact development practices, including grass channels, at stormwater hotspots and in areas known to provide groundwater recharge to water supply aquifers, unless adequate pretreatment is provided upstream of them. Use dry swales (Section 7.8.15) with liners and underdrains at stormwater hotspots and in areas known to provide groundwater recharge to water supply aquifers.
<ul style="list-style-type: none"> <i>Flat terrain</i> 	<ul style="list-style-type: none"> May be difficult to provide positive drainage and may cause stormwater runoff to pond in the bottom of the grass channel. 	<ul style="list-style-type: none"> Design grass channels with a slope of at least 0.5% to help ensure adequate drainage. Where soils are sufficiently permeable, use infiltration practices (Section 7.8.14) and non-underdrained bioretention areas (Section 7.8.13) and dry swales (Section 7.8.15), to reduce stormwater runoff volumes and prevent ponding in these areas. Where soils have low permeabilities, use wet swales (Section 8.6.6) instead of grass channels to intercept, convey and treat stormwater runoff.
<ul style="list-style-type: none"> <i>Shallow water table</i> 	<ul style="list-style-type: none"> May occasionally cause stormwater runoff to pond in the bottom of the grass channel. 	<ul style="list-style-type: none"> Use wet swales (i.e., linear wetland systems) (Section 8.6.6) to intercept, convey and treat stormwater runoff in these areas.

Table 7.21: Challenges Associated with Using Grass Channels in Coastal Georgia

Site Characteristic	How it Influences the Use of Grass Channels	Potential Solutions
<ul style="list-style-type: none"> <i>Tidally-influenced drainage system</i> 	<ul style="list-style-type: none"> May occasionally prevent stormwater runoff from being conveyed through a grass channel, particularly during high tide. 	<ul style="list-style-type: none"> Investigate the use of other low impact development practices, such as rainwater harvesting (Section 7.8.12) to “receive” stormwater runoff in these areas.

Site Applicability

Although it may be difficult to use them to “receive” stormwater runoff in urban areas, due to space constraints, grass channels can be used to “receive” stormwater runoff on a wide variety of development sites, including residential, commercial, industrial and institutional development sites in rural and suburban areas. When compared with other low impact development practices, grass channels have a relatively low construction cost, a moderate maintenance burden and require only a moderate amount of surface area.

Planning and Design Criteria

It is *recommended* that the grass channels used to “receive” stormwater runoff on a development site meet all of the following criteria to be eligible for the stormwater management “credits” described above:

General Planning and Design

- Grass channels should be used to “receive” stormwater runoff from relatively small drainage areas of 5 acres or less. The stormwater runoff rates and volumes from larger contributing drainage areas typically become too large to be properly conveyed within a grass channel.
- Although grass channels may be installed on development sites with slopes of between 0.5% and 3%, it is recommended that they be designed with slopes of between 1% and 2% to help ensure adequate drainage. Slopes greater than 3% would encourage erosion within the grass channel, while slopes less than 0.5% would encourage ponding.
- Grass channels should be designed to accommodate the peak discharge rate generated by the target runoff reduction rainfall event (e.g., 85th percentile rainfall event). The required dimensions of a grass channel can be determined using the design procedures provided in Section 3.3.2 of Volume 2 of the *Georgia Stormwater Management Manual* (ARC, 2001).
- To help prevent erosion within grass channels, the peak discharge rate generated by the target runoff reduction rainfall event (e.g., 85th percentile rainfall event) should be designed to flow through a grass channel at a velocity of 1.0 foot per second (ft/s) or less.
- To provide adequate residence time for stormwater runoff, grass channels should be designed to provide at least 10 minutes of residence time for the peak discharge rate generated by the target runoff reduction rainfall event (e.g., 85th percentile rainfall event) (Claytor and Schueler, 1996). Residence times may be increased by adjusting channel dimensions, slopes and vegetative covers or by including check dams in the channel design.
- The bottom of a grass channel should be designed to be between 2 and 8 feet wide. Channel bottoms greater than 8 feet wide encourage channel braiding, while channel bottoms less than 2 feet wide encourage soil erosion. If a channel bottom needs to be more than 8 feet wide to accommodate the peak discharge rate generated by the

target runoff reduction rainfall event, the use of a compound channel cross-section (e.g., two smaller channels separated by a permeable berm) is recommended.

- Grass channels should be designed with trapezoidal or parabolic cross-sections, and should be designed with side slopes of 3:1 (H:V) or flatter.
- The depth from the bottom of a grass channel to the top of the water table should be at least 2 feet to help prevent ponding and ensure proper operation of the grass channel. On development sites with high water tables, wet swales (Section 8.6.6) should be used to intercept, convey and treat post-construction stormwater runoff.
- Consideration should be given to the stormwater runoff rates and volumes generated by larger storm events (e.g., 25-year, 24-hour storm event) to help ensure that they do not cause localized flooding or significant damage to grass channels. Grass channels should be designed to be able to safely convey the overbank flood protection rainfall event (e.g., 25-year, 24-hour event). If necessary, a bypass channel or overflow spillway may be used to manage the stormwater runoff generated by larger storm events.
- Grass channels should not be used to “receive” stormwater runoff from stormwater hotspots, unless adequate pretreatment is provided upstream of them.

Landscaping

- A landscaping plan should be prepared for all grass channels. The landscaping plan should be reviewed and approved by the local development review authority prior to construction.
- Vegetation commonly planted in grass channels includes turf, shrubs, trees and other herbaceous vegetation. Although managed turf is most commonly used, site planning and design teams are encouraged to use trees, shrubs and/or other native vegetation to help establish mature native plant communities in and around grass channels.
- When developing a landscaping plan, site planning and design teams should choose grasses and other vegetation that will be able to stabilize soils and tolerate the stormwater runoff rates and volumes that will pass through the grass channel. Vegetation used in grass channels should also be able to tolerate both wet and dry conditions. See Appendix F of Volume 2 of the *Georgia Stormwater Management Manual* (ARC, 2001) for a list of grasses and other plants that are appropriate for use in grass channels in the state of Georgia.
- Methods used to establish vegetative cover within a grass channel should achieve at least 90 percent vegetative cover one year after installation.
- To help prevent soil erosion and sediment loss, landscaping should be provided immediately after the grass channel has been installed. Temporary irrigation may be needed to quickly establish vegetative cover within a grass channel.

Construction Considerations

To help ensure that grass channels are successfully installed on a development site, site planning and design teams should consider the following recommendations:

- Grass channels should be installed only after their contributing drainage areas have been completely stabilized.
- Simple erosion and sediment control measures, such as temporary seeding and erosion control mats, should be used on grass channels. Appropriate measures should be taken (e.g., silt fence, temporary diversion berm) to pretreat and/or divert post-construction stormwater runoff around a grass channel until vegetative cover has been established.
- To help prevent soil compaction, heavy vehicular and foot traffic should be kept out of grass channels during and after construction.

- Construction contracts should contain a replacement warranty that covers at least three growing seasons to help ensure adequate growth and survival of the vegetation planted within a grass channel.

Maintenance Requirements

Maintenance is very important for grass channels, particularly in terms of ensuring that they continue to provide measurable stormwater management benefits over time. Consequently, a legally binding inspection and maintenance agreement and plan should be created to help ensure that they are properly maintained after construction is complete. Table 7.22 provides a list of the routine maintenance activities typically associated with grass channels. It is important to note that grass channels have maintenance requirements that are very similar to those of other vegetated low impact development practices.

Activity	Schedule
<ul style="list-style-type: none"> • Water to promote plant growth and survival. • Inspect grass channel following rainfall events. Plant replacement vegetation in any eroded areas. 	As Needed (Following Construction)
<ul style="list-style-type: none"> • Inspect grass channel. Maintain vegetation (e.g., mow, prune, trim) as needed. • Remove accumulated trash and debris. 	Regularly (Monthly)
<ul style="list-style-type: none"> • Inspect grass channel for sediment accumulation. Remove sediment when it accounts for 25% or more of the original channel cross-section. • Inspect grass channel for erosion and the formation of rills and gullies. Plant replacement vegetation in any eroded areas. • Inspect grass channel for dead or dying vegetation. Plant replacement vegetation as needed. 	Annually (Semi-Annually During First Year)

Additional Resources

Claytor, R. and T. Schueler. 1996. *Design of Stormwater Filtering Systems*. Prepared for: Chesapeake Research Consortium, Inc. Center for Watershed Protection. Ellicott City, MD. Available Online: http://www.cwp.org/Resource_Library/Controlling_Runoff_and_Discharges/sm.htm.

Atlanta Regional Commission (ARC). 2001. "Grass Channel." *Georgia Stormwater Management Manual*. Volume 2. Technical Handbook. Section 3.3.2. Atlanta Regional Commission. Atlanta, GA. Available Online: <http://www.georgia-stormwater.com/>.

Atlanta Regional Commission (ARC). 2001. "Open Channel Design." *Georgia Stormwater Management Manual*. Volume 2. Technical Handbook. Section 4.4. Atlanta Regional Commission. Atlanta, GA. Available Online: <http://www.georgiastormwater.com/>.

Atlanta Regional Commission (ARC). 2001. "Site Design Credit #3: Vegetated Channels." *Georgia Stormwater Management Manual*. Volume 2. Technical Handbook. Section 1.4.4.5. Atlanta Regional Commission. Atlanta, GA. Available Online: <http://www.georgiastormwater.com/>.

7.8.8 Simple Downspout Disconnection

Description

Where site characteristics permit, simple downspout disconnections can be used to spread rooftop runoff from individual downspouts across lawns and other pervious areas, where it is slowed, filtered and allowed to infiltrate into the native soils. They are typically used in areas that have been disturbed by clearing, grading and other land disturbing activities and are typically vegetated with managed turf. If properly designed, simple downspout disconnections can provide measurable reductions in post-construction stormwater runoff rates, volumes and pollutant loads on development sites. Consequently, they can be used to help satisfy the SWM Criteria presented in this CSS.



(Source: Center for Watershed Protection)

<p style="text-align: center;"><u>KEY CONSIDERATIONS</u></p> <p>DESIGN CRITERIA:</p> <ul style="list-style-type: none"> • Length of flow path in contributing drainage areas should be 75 feet or less • Length of flow path in pervious areas below simple downspout disconnections should be at least 15 feet long and equal to or greater than the length of the flow path in their contributing drainage areas • Downspout disconnections should be designed to convey stormwater runoff away from buildings to prevent damage to building foundations <p>BENEFITS:</p> <ul style="list-style-type: none"> • Helps restore pre-development hydrology on development sites and reduces post-construction stormwater runoff rates, volumes and pollutant loads • Relatively low construction cost and long-term maintenance burden <p>LIMITATIONS:</p> <ul style="list-style-type: none"> • Can only be used to “receive” runoff from small drainage areas of 2,500 square feet or less • Provides greater stormwater management benefits on sites with permeable soils (i.e., hydrologic soil group A and B soils) 	<p style="text-align: center;"><u>STORMWATER MANAGEMENT “CREDITS”</u></p> <ul style="list-style-type: none"> <input checked="" type="checkbox"/> Runoff Reduction <input checked="" type="checkbox"/> Water Quality Protection <input checked="" type="checkbox"/> Aquatic Resource Protection <input checked="" type="checkbox"/> Overbank Flood Protection <input checked="" type="checkbox"/> Extreme Flood Protection <p><input checked="" type="checkbox"/> = practice has been assigned quantifiable stormwater management “credits” that can be used to address this SWM Criteria</p>						
<p style="text-align: center;"><u>SITE APPLICABILITY</u></p> <table border="0"> <tr> <td><input checked="" type="checkbox"/> Rural Use</td> <td><input type="checkbox"/> L Construction Cost</td> </tr> <tr> <td><input checked="" type="checkbox"/> Suburban Use</td> <td><input type="checkbox"/> L Maintenance</td> </tr> <tr> <td><input checked="" type="checkbox"/> * Urban Use</td> <td><input type="checkbox"/> M Area Required</td> </tr> </table>	<input checked="" type="checkbox"/> Rural Use	<input type="checkbox"/> L Construction Cost	<input checked="" type="checkbox"/> Suburban Use	<input type="checkbox"/> L Maintenance	<input checked="" type="checkbox"/> * Urban Use	<input type="checkbox"/> M Area Required	<p style="text-align: center;"><u>STORMWATER MANAGEMENT PRACTICE PERFORMANCE</u></p> <p>Runoff Reduction 25%-50% - Annual Runoff Volume 30%-60% - Runoff Reduction Volume</p> <p>Pollutant Removal¹ 80% - Total Suspended Solids 25% - Total Phosphorus 25% - Total Nitrogen 40% - Metals N/A - Pathogens</p> <p>1 = expected annual pollutant load removal</p>
<input checked="" type="checkbox"/> Rural Use	<input type="checkbox"/> L Construction Cost						
<input checked="" type="checkbox"/> Suburban Use	<input type="checkbox"/> L Maintenance						
<input checked="" type="checkbox"/> * Urban Use	<input type="checkbox"/> M Area Required						

Discussion

As the name implies, a simple downspout disconnection is the most basic of all of the low impact development practices that can be used to “receive” rooftop runoff. Where site characteristics permit, they can be used to spread rooftop runoff from individual downspouts across lawns and other pervious areas, where it is slowed, filtered and allowed to infiltrate into the native soils. If properly designed, simple downspout disconnections can provide measurable reductions in post-construction stormwater runoff rates, volumes and pollutant loads on development sites and, consequently, can be used to help satisfy the SWM Criteria presented in this CSS.

In order to use simple downspout disconnections to “receive” post-construction stormwater runoff, downspouts must be designed to discharge to a lawn or other pervious area (Figure 7.35). The pervious area located below the simple downspout disconnection should slope away from buildings and other impervious surfaces to prevent damage to building foundations and discourage rooftop runoff from “reconnecting” with the storm drain system.

The primary concern associated with a simple downspout disconnection (Figure 7.36) is the length of the flow path in the lawn or other pervious area located below the disconnection point. In order to provide adequate residence time for stormwater runoff, the length of the flow path in the pervious area located below a simple downspout disconnection should be equal to or greater than the length of the flow path of the contributing drainage area. If this cannot be accomplished, due to site characteristics or constraints, site planning and design teams should consider using other low impact development practices, such as vegetated filter strips (Section 7.8.6), rain gardens (Section 7.8.9), dry wells (Section 7.8.11) and rainwater harvesting (Section 7.8.12), on the development site.

Stormwater Management “Credits”

The Center for Watershed Protection (Hirschman et al., 2008) recently documented the ability of simple downspout disconnections to reduce annual stormwater runoff volumes and pollutant loads on development sites. Consequently, this low impact development practice has been assigned quantifiable stormwater management “credits” that can be used to help satisfy the SWM Criteria presented in this CSS:

- Stormwater Runoff Reduction: Reduce the runoff reduction volume (RR_v) conveyed through a *simple downspout disconnection* located on A/B or amended soils by 60%. Reduce the runoff reduction volume (RR_v) conveyed through a *simple downspout disconnection* located on C/D soils by 30%.



Figure 7.35: Simple Downspout Disconnections to Pervious Areas
(Source: Center for Watershed Protection)

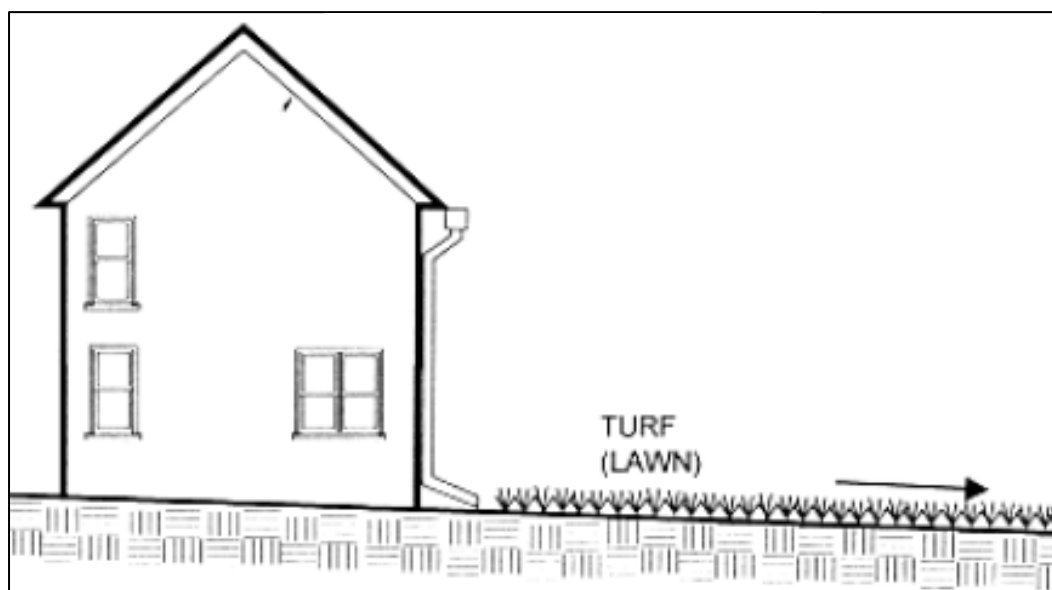

Figure 7.36: Simple Downspout Disconnection

(Source: Maryland Department of the Environment, 2000)

- Water Quality Protection: Reduce the runoff reduction volume (RR_v) conveyed through a *simple downspout disconnection* located on A/B or amended soils by 60%. Reduce the runoff reduction volume (RR_v) conveyed through a *simple downspout disconnection* located on C/D soils by 30%.
- Aquatic Resource Protection: Proportionally adjust the post-development runoff curve number (CN) to account for the runoff reduction provided by a *simple downspout disconnection* when calculating the aquatic resource protection volume (ARP_v) on a development site.
- Overbank Flood Protection: Proportionally adjust the post-development runoff curve number (CN) to account for the runoff reduction provided by a *simple downspout disconnection* when calculating the overbank peak discharge (Q_{p25}) on a development site.
- Extreme Flood Protection: Proportionally adjust the post-development runoff curve number (CN) to account for the runoff reduction provided by a *simple downspout disconnection* when calculating the extreme peak discharge (Q_{p100}) on a development site.

In order to “receive” stormwater runoff and be eligible for these “credits,” it is *recommended* that simple downspout disconnections satisfy the planning and design criteria outlined below.

Overall Feasibility

The criteria listed in Table 7.23 should be evaluated to determine whether or not a simple downspout disconnection is appropriate for use on a development site.

Table 7.23: Factors to Consider When Evaluating the Overall Feasibility of Using a Simple Downspout Disconnection on a Development Site

Site Characteristic	Criteria
Drainage Area	The size of the contributing drainage area should be 2,500 square feet or less. The length of the flow path in the contributing drainage area should be 75 feet or less.
Area Required	The length of flow path in the pervious area below a simple downspout disconnection should be at least 15 feet long and equal to or greater than the length of the flow path in its contributing drainage area.
Slope	Although simple downspout disconnections may be used on development sites with slopes of between 0.5% and 6%, it is recommended that they be designed with slopes of between 1% and 5% to help ensure adequate drainage.
Minimum Head	N/A
Minimum Depth to Water Table	No restrictions
Soils	No restrictions, although simple downspout disconnections located on permeable soils (i.e., hydrologic soil group A or B soils) provide greater stormwater management benefits.

Feasibility in Coastal Georgia

Several site characteristics commonly encountered in coastal Georgia may present challenges to site planning and design teams that are interested in using simple downspout disconnections to “receive” post-construction stormwater runoff on a development site. Table 7.24 identifies these common site characteristics and describes how they influence the use of simple downspout disconnections on development sites. The table also provides site planning and design teams with some ideas about how they can work around these potential constraints.

Table 7.24: Challenges Associated with Using Simple Downspout Disconnections in Coastal Georgia

Site Characteristic	How it Influences the Use of Downspout Disconnections	Potential Solutions
<ul style="list-style-type: none"> <i>Poorly drained soils, such as hydrologic soil group C and D soils</i> 	<ul style="list-style-type: none"> Reduces the ability of simple downspout disconnections to reduce stormwater runoff rates, volumes and pollutant loads. 	<ul style="list-style-type: none"> Use soil restoration (Section 7.8.1) to improve soil porosity and the ability of simple downspout disconnections to reduce stormwater runoff rates, volumes and pollutant loads. Use additional downspout disconnection practices, such as rain gardens (Section 7.8.9), dry wells (Section 7.8.11) and rainwater harvesting (Section 7.8.12) to supplement the stormwater management benefits provided by simple downspout disconnections.

Table 7.24: Challenges Associated with Using Simple Downspout Disconnections in Coastal Georgia

Site Characteristic	How it Influences the Use of Downspout Disconnections	Potential Solutions
<ul style="list-style-type: none"> • <i>Well drained soils, such as hydrologic soil group A and B soils</i> 	<ul style="list-style-type: none"> • Enhances the ability of simple downspout disconnections to reduce stormwater runoff rates, volumes and pollutant loads, but may allow stormwater pollutants to reach groundwater aquifers with greater ease. 	<ul style="list-style-type: none"> • Rooftop runoff is relatively clean, so this should not prevent the use of simple downspout disconnections, even at stormwater hotspots and in areas known to provide groundwater recharge to water supply aquifers. However, rooftop runoff should not be allowed to comingle with runoff from other impervious surfaces in these areas if it will be "received" by a simple downspout disconnection.
<ul style="list-style-type: none"> • <i>Flat terrain</i> 	<ul style="list-style-type: none"> • May be difficult to provide adequate drainage and may cause stormwater runoff to pond in the pervious area located below a simple downspout disconnection. 	<ul style="list-style-type: none"> • Design the pervious area located below the simple downspout disconnection with a slope of at least 0.5% to help ensure adequate drainage. • Where soils are well drained, use rain gardens (Section 7.8.9), non-underdrained bioretention areas (Section 7.8.13) and infiltration practices (Section 7.8.14), to reduce stormwater runoff rates, volumes and pollutant loads and prevent ponding in these areas. • Where soils are poorly drained, use rainwater harvesting (Section 7.8.12), small stormwater wetlands (i.e., pocket wetlands) (Section 8.6.2) or wet swales (Section 8.6.6), instead of simple downspout disconnection to intercept and treat stormwater runoff.
<ul style="list-style-type: none"> • <i>Shallow water table</i> 	<ul style="list-style-type: none"> • May occasionally cause stormwater runoff to pond in the pervious area located below a simple downspout disconnection. 	<ul style="list-style-type: none"> • Use rainwater harvesting (Section 7.8.9), small stormwater wetlands (i.e., pocket wetlands) (Section 8.6.2) or wet swales (Section 8.6.6), instead of downspout disconnection to intercept and treat stormwater runoff in these areas.

Table 7.24: Challenges Associated with Using Simple Downspout Disconnections in Coastal Georgia

Site Characteristic	How it Influences the Use of Downspout Disconnections	Potential Solutions
<ul style="list-style-type: none"> <i>Tidally-influenced drainage system</i> 	<ul style="list-style-type: none"> May occasionally prevent stormwater runoff from being conveyed through the pervious area located below a simple downspout disconnection, particularly during high tide. 	<ul style="list-style-type: none"> Investigate the use of other low impact development practices, such as rainwater harvesting (Section 7.8.12) to “receive” stormwater runoff in these areas.

Site Applicability

Although it may be difficult to use them to “receive” stormwater runoff in urban areas, due to space constraints, simple downspout disconnections can be used to “receive” stormwater runoff on a wide variety of development sites, including residential, commercial, industrial and institutional development sites in rural and suburban areas. When compared with other low impact development practices, simple downspout disconnections have a relatively low construction cost, a relatively low maintenance burden and require only a moderate amount of surface area.

Planning and Design Criteria

It is *recommended* that simple downspout disconnections meet all of the following criteria to be eligible for the stormwater management “credits” described above:

General Planning and Design

- Simple downspout disconnections should be used to “receive” stormwater runoff from small drainage areas of 2,500 square feet or less. The stormwater runoff rates and volumes from larger contributing drainage areas typically become too large to be properly “received” by simple downspout disconnections.
- The length of the flow path within the contributing drainage area should be 75 feet or less. In contributing drainage areas with longer flow paths, stormwater runoff tends to become shallow, concentrated flow (Claytor and Schueler, 1996), which can cause soil erosion and can significantly reduce the stormwater management benefits that simple downspout disconnections can provide. In these situations, grass channels (Section 7.8.7) or swales (Section 8.6.6) should be used to “receive” post-construction stormwater runoff.
- To provide adequate residence time for stormwater runoff, the length of the flow path in the pervious area located below a simple downspout disconnection should be at least 15 feet long and equal to or greater than the length of the flow path in its contributing drainage area. If this cannot be accomplished, due to site characteristics or constraints, site planning and design teams should consider using other low impact development practices, such as vegetated filter strips (Section 7.8.6), rain gardens (Section 7.8.9), dry wells (Section 7.8.11) and rainwater harvesting (Section 7.8.12), on the development site.
- Although simple downspout disconnections may be used on development sites with slopes of between 0.5% and 6%, it is recommended that they be designed with slopes of between 1% and 5% to help ensure adequate drainage. Slopes greater than 6% would encourage erosion within the pervious area located below the simple downspout disconnection, while slopes less than 0.5% would encourage ponding.
- All simple downspout disconnections should be designed to convey stormwater runoff away from buildings to prevent damage to building foundations. This typically involves extending downspouts to a point that is at least 2 feet away from buildings that do not

have basements or to a point that is at least 6 feet away from buildings that do have basements.

- All simple downspout disconnections should be located at least 10 feet away from all impervious surfaces of equal or lower elevation to discourage rooftop runoff from “reconnecting” with the storm drain system.

Landscaping

- Vegetation commonly planted in the pervious areas located below simple downspout disconnections includes turf, shrubs, trees and other herbaceous vegetation. Although managed turf is most commonly used, site planning and design teams are encouraged to use trees, shrubs and/or other native vegetation to help establish mature native plant communities in the pervious areas located below simple downspout disconnections.
- Methods used to establish vegetative cover within the pervious area located below a simple downspout disconnection should achieve at least 75 percent vegetative cover one year after installation.
- To help prevent soil erosion and sediment loss, landscaping should be provided immediately after the simple downspout disconnection has been completed. Temporary irrigation may be needed to quickly establish vegetative cover within the pervious areas located below simple downspout disconnections.

Construction Considerations

To help ensure that simple downspout disconnections are properly installed on a development site, site planning and design teams should consider the following recommendations:

- Simple erosion and sediment control measures, such as temporary seeding and erosion control mats, should be used within the pervious areas located below simple downspout disconnections.
- To help prevent soil compaction, heavy vehicular and foot traffic should be kept out of the pervious areas located below simple downspout disconnections during and immediately after construction.
- Construction contracts should contain a replacement warranty that covers at least three growing seasons to help ensure adequate growth and survival of the vegetation planted within the pervious area located below a simple downspout disconnection.

Maintenance Requirements

Simple downspout disconnections typically require very little long-term maintenance, but a legally binding inspection and maintenance agreement and plan should be created to help ensure that they are properly maintained after construction is complete. Table 7.25 provides a list of the maintenance activities typically associated with simple downspout disconnections.

Table 7.25: Routine Maintenance Activities Typically Associated with Simple Downspout Disconnections	
Activity	Schedule
<ul style="list-style-type: none"> • Pervious areas located below simple downspout disconnections should be watered to promote plant growth and survival. • Inspect the pervious areas located below simple downspout disconnections following rainfall events. Plant replacement vegetation in any eroded areas. 	<p>As Needed (Following Construction)</p>

Table 7.25: Routine Maintenance Activities Typically Associated with Simple Downspout Disconnections

Activity	Schedule
<ul style="list-style-type: none"> • Inspect pervious area located below simple downspout disconnection. Maintain vegetation (e.g., mow, prune, trim) as needed. • Remove accumulated trash and debris in pervious area located below the simple downspout disconnection. 	Regularly (Monthly)
<ul style="list-style-type: none"> • Inspect gutters and downspouts. Remove any accumulated leaves or debris. • Inspect the pervious areas located below simple downspout disconnections for erosion and the formation of rills and gullies. Plant replacement vegetation in any eroded areas. • Inspect the pervious areas located below simple downspout disconnections for dead or dying vegetation. Plant replacement vegetation as needed. 	Annually (Semi-Annually During First Year)

Additional Resources

Schueler, T., D. Hirschman, M. Novotney and J. Zielinski. 2007. *Urban Stormwater Retrofit Practices. Manual 3: Urban Subwatershed Restoration Manual Series*. Center for Watershed Protection. Ellicott City, MD. Available Online: http://www.cwp.org/Resource_Library/Controlling_Runoff_and_Discharges/sm.htm.

Minnesota Pollution Control Agency (MPCA). 2006. "Credit 5: Rooftop Disconnection Credit." *Minnesota Stormwater Manual*. Section 11.3.2. Minnesota Pollution Control Agency. Available Online: <http://www.pca.state.mn.us/water/stormwater/stormwater-manual.html>.

City of Portland, OR. 2008. *Downspout Disconnection Program*. Bureau of Environmental Services. City of Portland, OR. Portland, OR. Available Online: <http://www.portlandonline.com/bes/index.cfm?c=43081>.

Novotney, M., P. Sturm, C. Swann and J. Tasillo. 2008. *Downspout Disconnection in the City of Baltimore, Maryland*. Prepared for: City of Baltimore, Maryland. Center for Watershed Protection. Ellicott City, MD.

7.8.9 Rain Gardens

Description

Rain gardens are small, landscaped depressional areas that are filled with amended native soils or an engineered soil mix and are planted with trees, shrubs and other herbaceous vegetation. They are designed to capture and temporarily store stormwater runoff so that it may be subjected to the hydrologic processes of evaporation, transpiration and infiltration. This allows rain gardens to provide measurable reductions in post-construction stormwater runoff rates, volumes and pollutant loads on development sites. Consequently, they can be used to help satisfy the SWM Criteria presented in this CSS.



(Source: R. Bannerman)

<p style="text-align: center;"><u>KEY CONSIDERATIONS</u></p> <p>DESIGN CRITERIA:</p> <ul style="list-style-type: none"> • Rain gardens should be designed to completely drain within 24 hours of the end of a rainfall event • A maximum ponding depth of 6 inches is recommended within rain gardens to help prevent the formation of nuisance ponding conditions • Unless a shallow water table is found on the development site, rain garden planting beds should be at least 2 feet deep <p>BENEFITS:</p> <ul style="list-style-type: none"> • Helps restore pre-development hydrology on development sites and reduces post-construction stormwater runoff rates, volumes and pollutant loads • Can be integrated into development plans as attractive landscaping features <p>LIMITATIONS:</p> <ul style="list-style-type: none"> • Can only be used to “receive” runoff from small drainage areas of 2,500 square feet or less • Provides greater stormwater management benefits on sites with permeable soils (i.e., hydrologic soil group A and B soils) 	<p style="text-align: center;"><u>STORMWATER MANAGEMENT “CREDITS”</u></p> <ul style="list-style-type: none"> <input checked="" type="checkbox"/> Runoff Reduction <input checked="" type="checkbox"/> Water Quality Protection <input checked="" type="checkbox"/> Aquatic Resource Protection <input checked="" type="checkbox"/> Overbank Flood Protection <input checked="" type="checkbox"/> Extreme Flood Protection <p><input checked="" type="checkbox"/> = practice has been assigned quantifiable stormwater management “credits” that can be used to address this SWM Criteria</p>						
<p style="text-align: center;"><u>SITE APPLICABILITY</u></p> <table border="0"> <tr> <td><input checked="" type="checkbox"/> Rural Use</td> <td><input type="checkbox"/> L Construction Cost</td> </tr> <tr> <td><input checked="" type="checkbox"/> Suburban Use</td> <td><input type="checkbox"/> M Maintenance</td> </tr> <tr> <td><input checked="" type="checkbox"/> * Urban Use</td> <td><input type="checkbox"/> M Area Required</td> </tr> </table>	<input checked="" type="checkbox"/> Rural Use	<input type="checkbox"/> L Construction Cost	<input checked="" type="checkbox"/> Suburban Use	<input type="checkbox"/> M Maintenance	<input checked="" type="checkbox"/> * Urban Use	<input type="checkbox"/> M Area Required	<p style="text-align: center;"><u>STORMWATER MANAGEMENT PRACTICE PERFORMANCE</u></p> <p>Runoff Reduction 80% - Annual Runoff Volume Varies¹ - Runoff Reduction Volume</p> <p>Pollutant Removal² 80% - Total Suspended Solids 80% - Total Phosphorus 80% - Total Nitrogen N/A - Metals 80% - Pathogens</p> <p>1 = varies according to storage capacity of the rain garden 2 = expected annual pollutant load removal</p>
<input checked="" type="checkbox"/> Rural Use	<input type="checkbox"/> L Construction Cost						
<input checked="" type="checkbox"/> Suburban Use	<input type="checkbox"/> M Maintenance						
<input checked="" type="checkbox"/> * Urban Use	<input type="checkbox"/> M Area Required						

Discussion

Rain gardens are small, landscaped depressional areas that are filled with amended native soils or an engineered soil mix and are planted with trees, shrubs and other herbaceous vegetation (Figure 7.37). They are designed to capture and temporarily store stormwater runoff so that it may be subjected to the hydrologic processes of evaporation, transpiration and infiltration. This allows them to provide measurable reductions in post-construction stormwater runoff rates, volumes and pollutant loads on development sites.



Figure 7.37: Various Rain Gardens

The primary concern associated with the design of a rain garden is its storage capacity, which directly influences its ability to reduce stormwater runoff rates, volumes and pollutant loads. Site planning and design teams should strive to design rain gardens that can accommodate the stormwater runoff volume generated by the target runoff reduction rainfall event (e.g., 85th percentile rainfall event). If this cannot be accomplished, due to site characteristics or constraints, site planning and design teams should consider using rain gardens in combination with other runoff reducing low impact development practices, such as dry wells (Section 7.8.11) and rainwater harvesting (Section 7.8.12), to provide more substantial reductions in stormwater runoff rates, volumes and pollutant loads.

Stormwater Management “Credits”

The Center for Watershed Protection (Hirschman et al., 2008) recently documented the ability of rain gardens to reduce annual stormwater runoff volumes and pollutant loads on development

sites. Consequently, this low impact development practice has been assigned quantifiable stormwater management “credits” that can be used to help satisfy the SWM Criteria presented in this CSS:

- Stormwater Runoff Reduction: Subtract 100% of the storage volume provided by a *rain garden* from the runoff reduction volume (RR_v) conveyed through the *rain garden*.
- Water Quality Protection: Subtract 100% of the storage volume provided by a *rain garden* from the runoff reduction volume (RR_v) conveyed through the *rain garden*.
- Aquatic Resource Protection: Proportionally adjust the post-development runoff curve number (CN) to account for the runoff reduction provided by a *rain garden* when calculating the aquatic resource protection volume (ARP_v) on a development site.
- Overbank Flood Protection: Proportionally adjust the post-development runoff curve number (CN) to account for the runoff reduction provided by a *rain garden* when calculating the overbank peak discharge (Q_{p25}) on a development site.
- Extreme Flood Protection: Proportionally adjust the post-development runoff curve number (CN) to account for the runoff reduction provided by a *rain garden* when calculating the extreme peak discharge (Q_{p100}) on a development site.

The storage volume provided by a rain garden can be determined using the following equation:

$$\text{Storage Volume} = \text{Surface Area} \times [\text{Ponding Depth} + (\text{Depth of Planting Bed} \times \text{Void Ratio})]$$

A void ratio (i.e., void space/total volume) of 0.32 should be used in all storage volume calculations, unless more specific planting bed void ratio data are available.

In order to “receive” stormwater runoff and be eligible for these “credits,” it is *recommended* that rain gardens satisfy the planning and design criteria outlined below.

Overall Feasibility

The criteria listed in Table 7.26 should be evaluated to determine whether or not a rain garden is appropriate for use on a development site.

Site Characteristic	Criteria
Drainage Area	The size of the contributing drainage area should be 2,500 square feet or less. The length of flow path in the contributing drainage area should be 150 feet or less in pervious drainage areas and 75 feet or less in impervious drainage areas. Bioretention areas (Section 7.8.13) should be used to “receive” stormwater runoff from larger contributing drainage areas or contributing drainage areas with longer flow paths.
Area Required	Rain garden surface area requirements vary according to the size of the contributing drainage area and the infiltration rate of the soils on which the rain garden will be located. In general, rain gardens require about 10-20% of the size of their contributing drainage areas.

Table 7.26: Factors to Consider When Evaluating the Overall Feasibility of Using a Rain Garden on a Development Site

Site Characteristic	Criteria
Slope	Although rain gardens may be used on development sites with slopes of up to 6%, they should be designed with slopes that are as close to flat as possible to help ensure that stormwater runoff is evenly distributed over the planting bed.
Minimum Head	Rain gardens may be designed with a maximum ponding depth of 12 inches, although a ponding depth of 6 inches is recommended to help prevent the formation of nuisance ponding conditions. Unless a shallow water table is found on the development site, all rain garden planting beds should be at least 24 inches deep.
Minimum Depth to Water Table	2 feet
Soils	Rain gardens should be designed to completely drain within 24 hours of the end of a rainfall event. Consequently, rain gardens generally should not be used on development sites that have soils with infiltration rates of less than 0.50 inches per hour (i.e., hydrologic soil group C and D soils). Underdrained bioretention areas (Section 7.8.13) may be used to "receive" stormwater runoff on development sites that have soils with infiltration rates of less than 0.50 inches per hour.

Feasibility in Coastal Georgia

Several site characteristics commonly encountered in coastal Georgia may present challenges to site planning and design teams that are interested in using rain gardens to "receive" post-construction stormwater runoff on a development site. Table 7.27 identifies these common site characteristics and describes how they influence the use of rain gardens on development sites. The table also provides site planning and design teams with some ideas about how they can work around these potential constraints.

Table 7.27: Challenges Associated with Using Rain Gardens in Coastal Georgia

Site Characteristic	How it Influences the Use of Rain Gardens	Potential Solutions
<ul style="list-style-type: none"> <i>Poorly drained soils, such as hydrologic soil group C and D soils</i> 	<ul style="list-style-type: none"> Reduces the ability of rain gardens to reduce stormwater runoff rates, volumes and pollutant loads. 	<ul style="list-style-type: none"> Use an engineered soil mix instead of amended native soils to create rain garden planting beds in these areas. Use additional downspout disconnection practices, such as rainwater harvesting (Section 7.8.12) to supplement the stormwater management benefits provided by rain gardens in these areas. Use rainwater harvesting (Section 7.8.9), small stormwater wetlands (i.e., pocket wetlands) (Section 8.6.2) or wet swales (Section 8.6.6), instead of rain gardens to intercept and treat stormwater runoff in these areas.

Table 7.27: Challenges Associated with Using Rain Gardens in Coastal Georgia

Site Characteristic	How it Influences the Use of Rain Gardens	Potential Solutions
<ul style="list-style-type: none"> <i>Well drained soils, such as hydrologic soil group A and B soils</i> 	<ul style="list-style-type: none"> Enhances the ability of rain gardens to reduce stormwater runoff rates, volumes and pollutant loads, but may allow stormwater pollutants to reach groundwater aquifers with greater ease. 	<ul style="list-style-type: none"> Rooftop runoff is relatively clean, so this should not prevent the use of rain gardens, even at stormwater hotspots and in areas known to provide groundwater recharge to water supply aquifers. However, rooftop runoff should not be allowed to comingle with runoff from other impervious surfaces in these areas if it will be "received" by a rain garden. Use bioretention areas (Section 7.8.13) and dry swales (Section 7.8.15) with liners and underdrains to intercept and treat non rooftop runoff at stormwater hotspots and in areas known to provide groundwater recharge to water supply aquifers.
<ul style="list-style-type: none"> <i>Flat terrain</i> 	<ul style="list-style-type: none"> May be difficult to provide adequate drainage and may cause stormwater runoff to pond in the rain garden for extended periods of time. 	<ul style="list-style-type: none"> Ensure that the underlying native soils will allow the rain garden to drain completely within 24 hours of the end of a rainfall event to prevent the formation of nuisance ponding conditions.
<ul style="list-style-type: none"> <i>Shallow water table</i> 	<ul style="list-style-type: none"> May be difficult to provide 2 feet of clearance between the bottom of the rain garden and the top of the water table. May occasionally cause stormwater runoff to pond in the rain garden. 	<ul style="list-style-type: none"> Ensure that the distance from the bottom of the rain garden to the top of the water table is at least 2 feet. Reduce the depth of the planting bed to 18 inches. Use rainwater harvesting (Section 7.8.12), small stormwater wetlands (i.e., pocket wetlands) (Section 8.6.2) or wet swales (Section 8.6.6), instead of rain gardens to intercept and treat stormwater runoff in these areas.
<ul style="list-style-type: none"> <i>Tidally-influenced drainage system</i> 	<ul style="list-style-type: none"> May occasionally prevent stormwater runoff from being conveyed through a rain garden, particularly during high tide. 	<ul style="list-style-type: none"> Investigate the use of other low impact development practices, such as rainwater harvesting (Section 7.8.12) to "receive" stormwater runoff in these areas.

Site Applicability

Although it may be difficult to use them to “receive” stormwater runoff in urban areas, due to space constraints, rain gardens can be used to “receive” stormwater management on a wide variety of development sites, including residential, commercial and institutional development sites in rural and suburban areas. Although they are particularly well suited to “receive” rooftop runoff, they can also be used to “receive” stormwater runoff from other small drainage areas, such as local streets and roadways, driveways, small parking areas and disturbed pervious areas (e.g., lawns, parks, community open spaces). When compared with other low impact development practices, rain gardens have a relatively low construction cost, a moderate maintenance burden and require only a moderate amount of surface area.

Planning and Design Criteria

It is *recommended* that rain gardens meet all of the following criteria to be eligible for the stormwater management “credits” described above:

General Planning and Design

- Rain gardens should be used to “receive” stormwater runoff from small drainage areas of 2,500 square feet or less. The stormwater runoff rates and volumes from larger contributing drainage areas typically become too large to be properly “received” by rain gardens.
- The length of the flow path within the contributing drainage area should be 150 feet or less for pervious drainage areas and 75 feet or less for impervious drainage areas. In contributing drainage areas with longer flow paths, stormwater runoff tends to become shallow, concentrated flow (Claytor and Schueler, 1996), which can cause soil erosion and can significantly reduce the stormwater management benefits that rain gardens can provide. In these situations, bioretention areas (Section 7.8.13) should be used to “receive” post-construction stormwater runoff.
- Although rain gardens may be installed on development sites with slopes of up to 6%, they should be designed with slopes that are as close to flat as possible to help ensure that stormwater runoff is evenly distributed over the planting bed.
- Rain gardens should be designed to provide enough storage for the stormwater runoff volume generated by the target runoff reduction rainfall event (e.g., 85th percentile rainfall event). Since they are essentially non-underdrained bioretention areas, the required dimensions of a rain garden can be determined using the design procedures provided in Section 8.6.3 of this CSS.
- Rain gardens should be designed to completely drain within 24 hours of the end of a rainfall event. Where site characteristics allow, it is preferable to design rain gardens to drain within 12 hours of the end of a rainfall event to help prevent the formation of nuisance ponding conditions.
- Rain gardens may be designed with a maximum ponding depth of 12 inches, although a ponding depth of 6 inches is recommended to help prevent the formation of nuisance ponding conditions.
- Unless a shallow water table is found on the development site, all rain garden planting beds should be at least 24 inches deep. If a shallow water table is found on the development site, the depth of the planting bed may be reduced to 18 inches.
- The soils used within rain garden planting beds may consist of either amended native soils or an engineered soil mix, but should meet the following specifications:
 - Texture: Sandy loam or loamy sand.
 - Sand Content: Soils should contain 85%-88% clean, washed sand.
 - Topsoil Content: Soils should contain 8%-12% topsoil.
 - Organic Matter Content: Soils should contain 3%-5% organic matter.

- Infiltration Rate: Soils should have an infiltration rate of at least 0.25 inches per hour (in/hr), although an infiltration rate of between 1 and 2 in/hr is preferred.
- Phosphorus Index (P-Index): Soils should have a P-Index of less than 30.
- Exchange Capacity (CEC): Soils should have a CEC that exceeds 10 milliequivalents (meq) per 100 grams of dry weight.
- pH: Soils should have a pH of 6-8.
- The organic matter used within a rain garden planting bed should be a well-aged compost that meets the specifications outlined in Section 7.8.1.
- All rain gardens should be located at least 10 feet away from buildings to prevent damage to building foundations.
- All rain gardens should be located at least 10 feet away from all impervious surfaces of equal or lower elevation to discourage rooftop runoff from “reconnecting” with the storm drain system.
- Rain gardens should be designed with side slopes of 3:1 (H:V) or flatter.
- The depth from the bottom of a rain garden to the top of the water table should be at least 2 feet to help prevent ponding and ensure proper operation of the rain garden. On development sites with high water tables, small stormwater wetlands (i.e., pocket wetlands) (Section 8.6.2) should be used to intercept and treat post-construction stormwater runoff.
- If used to “receive” non rooftop runoff, rain gardens should be preceded by a pea gravel diaphragm or equivalent level spreader device (e.g., concrete sills, curb stops, curbs with “sawteeth” cut into them) to intercept stormwater runoff and distribute it evenly, as overland sheet flow, into the rain garden.
- Consideration should be given to the stormwater runoff rates and volumes generated by larger storm events (e.g., 25-year, 24-hour storm event) to help ensure that these larger storm events are able to safely bypass the rain garden. An overflow system, such as a spillway with an invert set slightly above the elevation of maximum ponding depth within the rain garden, should be designed to convey the stormwater runoff generated by these larger storm events safely out of the rain garden.

Landscaping

- A landscaping plan should be prepared for all rain gardens. The landscaping plan should be reviewed and approved by the local development review authority prior to construction.
- Vegetation commonly planted in rain gardens includes native trees, shrubs and other herbaceous vegetation. When developing a landscaping plan, site planning and design teams should choose vegetation that will be able to stabilize soils and tolerate the stormwater runoff rates and volumes that will pass through the rain garden. Vegetation used in rain gardens should also be able to tolerate both wet and dry conditions. See Appendix F of Volume 2 of the *Georgia Stormwater Management Manual* (ARC, 2001) for a list of grasses and other plants that are appropriate for use in rain gardens in the state of Georgia.
- A mulch layer, consisting of 2-4 inches of fine shredded hardwood mulch or shredded hardwood chips, should be included on the surface of the rain garden.
- Methods used to establish vegetative cover within a rain garden should achieve at least 75 percent vegetative cover one year after installation.
- To help prevent soil erosion and sediment loss, landscaping should be provided immediately after the rain garden has been installed. Temporary irrigation may be needed to quickly establish vegetative cover within a rain garden.

Construction Considerations

To help ensure that rain gardens are successfully installed on a development site, site planning and design teams should consider the following recommendations:

- If rain gardens will be used to “receive” non rooftop runoff, they should only be installed after their contributing drainage areas have been completely stabilized.
- Simple erosion and sediment control measures, such as temporary seeding and erosion control mats, should be used within rain gardens. Appropriate measures should be taken (e.g., silt fence, temporary diversion berm) to pretreat and/or divert post-construction stormwater runoff around a rain garden until vegetative cover has been established.
- To help prevent soil compaction, heavy vehicular and foot traffic should be kept out of rain gardens before, during and after construction. This can typically be accomplished by clearly delineating rain gardens on all development plans and, if necessary, protecting them with temporary construction fencing.
- The native soils along the bottom of the rain garden should be scarified or tilled to a depth of 3 to 4 inches prior to the placement of the amended native soils or engineered soil mix.
- Construction contracts should contain a replacement warranty that covers at least three growing seasons to help ensure adequate growth and survival of the vegetation planted within a rain garden.

Maintenance Requirements

Maintenance is very important for rain gardens, particularly in terms of ensuring that they continue to provide measurable stormwater management benefits over time. Consequently, a legally binding inspection and maintenance agreement and plan should be created to help ensure that they are properly maintained after construction is complete. Table 7.28 provides a list of the routine maintenance activities typically associated with rain gardens. It is important to note that rain gardens have maintenance requirements that are very similar to those of other vegetated low impact development practices.

Activity	Schedule
<ul style="list-style-type: none"> • Water to promote plant growth and survival. • Inspect rain garden following rainfall events. Plant replacement vegetation in any eroded areas. 	As Needed (Following Construction)
<ul style="list-style-type: none"> • Prune and weed rain garden. • Remove accumulated trash and debris. 	Regularly (Monthly)
<ul style="list-style-type: none"> • Inspect inflow area for sediment accumulation. Remove any accumulated sediment or debris. • Inspect rain garden for erosion and the formation of rills and gullies. Plant replacement vegetation in any eroded areas. • Inspect rain garden for dead or dying vegetation. Plant replacement vegetation as needed. • Replace mulch. 	Annually (Semi-Annually During First Year)

Additional Resources

Hunt, W.F. and W.G. Lord. 2006. “Bioretention Performance, Design, Construction and Maintenance.” *North Carolina Cooperative Extension Service Bulletin*. Urban Waterways Series. AG-588-5. North Carolina State University. Raleigh, NC. Available Online: <http://www.bae.ncsu.edu/stormwater/PublicationFiles/Bioretention2006.pdf>.

Biohabitats, Inc. 2005. *Bioretention Guidance*. Prepared for: Lake County, OH. Stormwater Management Department. Available Online:
<http://www2.lakecountyohio.org/smd/Forms.htm>.

Atlanta Regional Commission (ARC). 2001. "Bioretention Areas." *Georgia Stormwater Management Manual*. Volume 2. Technical Handbook. Section 3.2.3. Atlanta Regional Commission. Atlanta, GA. Available Online:
<http://www.georgia-stormwater.com/>.

THIS PAGE INTENTIONALLY LEFT BLANK

7.8.10 Stormwater Planters

Description

Stormwater planters are landscape planter boxes that are specially designed to “receive” post-construction stormwater runoff. They consist of planter boxes that are equipped with waterproof liners, filled with an engineered soil mix and planted with trees, shrubs and other herbaceous vegetation. Stormwater planters are designed to capture and temporarily store stormwater runoff in the engineered soil mix, where it is subjected to the hydrologic processes of evaporation and transpiration before being conveyed back into the storm drain system through an underdrain. This allows them to provide measurable reductions in post-construction stormwater runoff rates, volumes and pollutant loads on development sites.



(Source: Center for Watershed Protection)

<p style="text-align: center;"><u>KEY CONSIDERATIONS</u></p> <p>DESIGN CRITERIA:</p> <ul style="list-style-type: none"> • Stormwater planters should be designed to completely drain within 24 hours of the end of a rainfall event • A maximum ponding depth of 6 inches is recommended within stormwater planters to help prevent the formation of nuisance ponding conditions • Unless a shallow water table is found on the development site, stormwater planter planting beds should be at least 2 feet deep <p>BENEFITS:</p> <ul style="list-style-type: none"> • Helps restore pre-development hydrology on development sites and reduces post-construction stormwater runoff rates, volumes and pollutant loads • Can be integrated into development plans as attractive landscaping features • Particularly well suited for use on urban development sites <p>LIMITATIONS:</p> <ul style="list-style-type: none"> • Can only be used to “receive” runoff from small drainage areas of 2,500 square feet or less 	<p style="text-align: center;"><u>STORMWATER MANAGEMENT “CREDITS”</u></p> <ul style="list-style-type: none"> <input checked="" type="checkbox"/> Runoff Reduction <input checked="" type="checkbox"/> Water Quality Protection <input checked="" type="checkbox"/> Aquatic Resource Protection <input checked="" type="checkbox"/> Overbank Flood Protection <input checked="" type="checkbox"/> Extreme Flood Protection <p><input checked="" type="checkbox"/> = practice has been assigned quantifiable stormwater management “credits” that can be used to address this SWM Criteria</p>
<p style="text-align: center;"><u>SITE APPLICABILITY</u></p> <p>Rural Use <input type="checkbox"/> Construction Cost <input type="checkbox"/> H</p> <p><input checked="" type="checkbox"/> Suburban Use <input type="checkbox"/> Maintenance <input type="checkbox"/> M</p> <p><input checked="" type="checkbox"/> Urban Use <input type="checkbox"/> Area Required <input type="checkbox"/> L</p>	<p style="text-align: center;"><u>STORMWATER MANAGEMENT PRACTICE PERFORMANCE</u></p> <p>Runoff Reduction 40% - Annual Runoff Volume Varies¹ - Runoff Reduction Volume</p> <p>Pollutant Removal² 80% - Total Suspended Solids 60% - Total Phosphorus 60% - Total Nitrogen N/A - Metals 80% - Pathogens</p> <p>1 = varies according to storage capacity of the stormwater planter 2 = expected annual pollutant load removal</p>

Discussion

Stormwater planters are essentially small, underdrained bioretention areas (Section 7.8.13) that are designed to fit within landscape planter boxes (Figure 7.38). They consist of landscape planter boxes that are equipped with waterproof liners, filled with an engineered soil mix and planted with trees, shrubs and other herbaceous vegetation. Stormwater planters are designed to capture and temporarily store stormwater runoff in the engineered soil mix, where it is subjected to the hydrologic processes of evaporation and transpiration before being conveyed back into the storm drain system through an underdrain. This allows them to provide measurable reductions in post-construction stormwater runoff rates, volumes and pollutant loads on development sites.



Figure 7.38: Various Stormwater Planters

The primary concern associated with the design of a stormwater planter (Figure 7.39) is its storage capacity, which directly influences its ability to reduce stormwater runoff rates, volumes and pollutant loads. Site planning and design teams should strive to design stormwater planters that can accommodate the stormwater runoff volume generated by the target runoff reduction rainfall event (e.g., 85th percentile rainfall event). If this cannot be accomplished, due to site characteristics or constraints, site planning and design teams should consider using stormwater planters in combination with other runoff reducing low impact development practices, such dry wells (Section 7.8.11) and rainwater harvesting (Section 7.8.12), to supplement the stormwater management benefits provided by the planters.

Stormwater Stormwater Management “Credits”

The Center for Watershed Protection (Hirschman et al., 2008) recently documented the ability of stormwater planters to reduce annual stormwater runoff volumes and pollutant loads on development sites. Consequently, this low impact development practice has been assigned quantifiable stormwater management “credits” that can be used to help satisfy the SWM Criteria presented in this CSS:

- Stormwater Runoff Reduction: Subtract 50% of the storage volume provided by a *stormwater planter* from the runoff reduction volume (RR_v) conveyed through the *stormwater planter*.

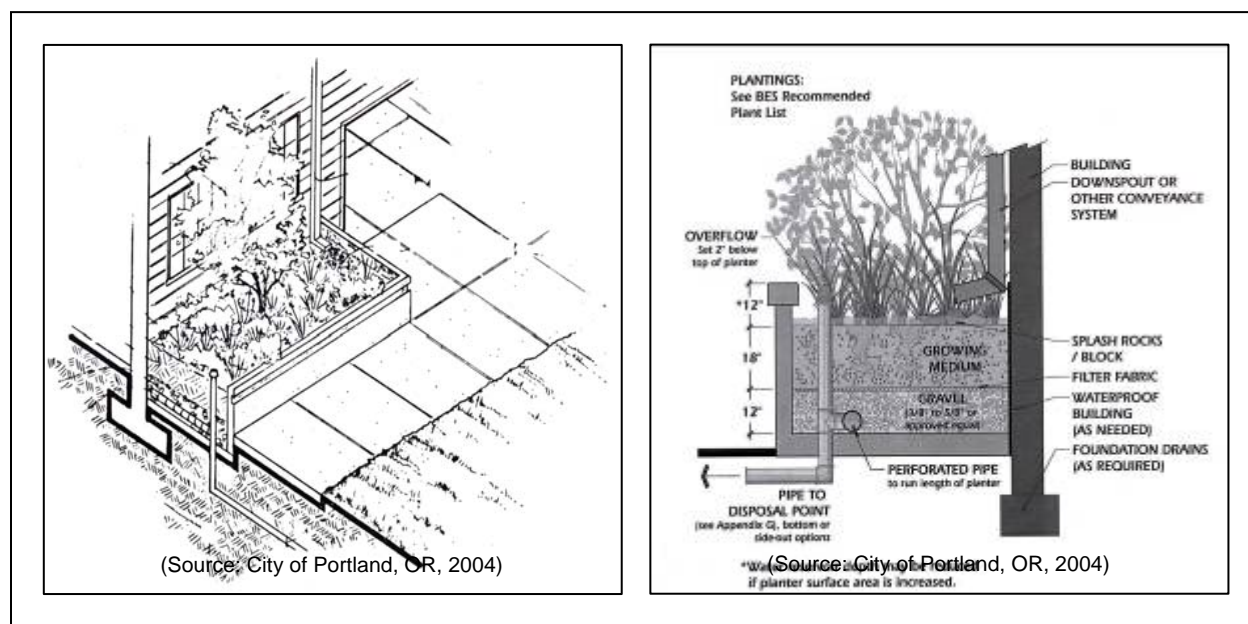

Figure 7.39: Stormwater Planters

- **Water Quality Protection:** Subtract 50% of the storage volume provided by a *stormwater planter* from the runoff reduction volume (RR_v) conveyed through the *stormwater planter*.
- **Aquatic Resource Protection:** Proportionally adjust the post-development runoff curve number (CN) to account for the runoff reduction provided by a *stormwater planter* when calculating the aquatic resource protection volume (ARP_v) on a development site.
- **Overbank Flood Protection:** Proportionally adjust the post-development runoff curve number (CN) to account for the runoff reduction provided by a *stormwater planter* when calculating the overbank peak discharge (Q_{p25}) on a development site.
- **Extreme Flood Protection:** Proportionally adjust the post-development runoff curve number (CN) to account for the runoff reduction provided by a *stormwater planter* when calculating the extreme peak discharge (Q_{p100}) on a development site.

The storage volume provided by a stormwater planter can be determined using the following equation:

$$\text{Storage Volume} = \text{Surface Area} \times [\text{Ponding Depth} + (\text{Depth of Planting Bed} \times \text{Void Ratio})]$$

A void ratio (i.e., void space/total volume) of 0.32 should be used in all storage volume calculations, unless more specific planting bed void ratio data are available.

In order to “receive” stormwater runoff and be eligible for these “credits,” it is *recommended* that stormwater planters satisfy the planning and design criteria outlined below.

Overall Feasibility

The criteria listed in Table 7.29 should be evaluated to determine whether or not a stormwater planter is appropriate for use on a development site.

Table 7.29: Factors to Consider When Evaluating the Overall Feasibility of Using a Stormwater Planter on a Development Site

Site Characteristic	Criteria
Drainage Area	The size of the contributing drainage area should be 2,500 square feet or less. The length of flow path in contributing drainage areas should be 150 feet or less in pervious drainage areas and 75 feet or less in impervious drainage areas. Bioretention areas (Section 7.8.13) should be used to “receive” stormwater runoff from larger contributing drainage areas or contributing drainage areas with longer flow paths.
Area Required	Stormwater planter surface area requirements vary according to the size of the contributing drainage area. In general, stormwater planters require about 5% of the size of their contributing drainage areas.
Slope	Although stormwater planters may be used on development sites with slopes of up to 6%, they should be designed with slopes that are as close to flat as possible to help ensure that stormwater runoff is evenly distributed over the planting bed.
Minimum Head	Stormwater planters may be designed with a maximum ponding depth of 12 inches, although a ponding depth of 6 inches is recommended to help prevent the formation of nuisance ponding conditions. Unless a shallow water table is found on the development site, all stormwater planter planting beds should be at least 24 inches deep.
Minimum Depth to Water Table	Unless a shallow water table is found on the development site, the distance from the bottom of a stormwater planter to the top of the water table should be at least 2 feet.
Soils	Stormwater planters should be designed to completely drain within 24 hours of the end of a rainfall event.

Feasibility in Coastal Georgia

Several site characteristics commonly encountered in coastal Georgia may present challenges to site planning and design teams that are interested in using stormwater planters to “receive” post-construction stormwater runoff on a development site. Table 7.30 identifies these common site characteristics and describes how they influence the use of stormwater planters on development sites. The table also provides site planning and design teams with some ideas about how they can work around these potential constraints.

Table 7.30: Challenges Associated with Using Stormwater Planters in Coastal Georgia

Site Characteristic	How it Influences the Use of Stormwater Planters	Potential Solutions
<ul style="list-style-type: none"> <i>Poorly drained soils, such as hydrologic soil group C and D soils</i> 	<ul style="list-style-type: none"> Since they are equipped with waterproof liners and underdrains, the presence of poorly drained soils does not influence the use of stormwater planters on development sites. 	
<ul style="list-style-type: none"> <i>Well drained soils, such as hydrologic soil group A and B soils</i> 	<ul style="list-style-type: none"> Since they are equipped with waterproof liners and underdrains, the presence of poorly drained soils does not influence the use of stormwater planters on development sites. 	

Table 7.30: Challenges Associated with Using Stormwater Planters in Coastal Georgia		
Site Characteristic	How it Influences the Use of Stormwater Planters	Potential Solutions
<ul style="list-style-type: none"> • <i>Flat terrain</i> 	<ul style="list-style-type: none"> • May be difficult to provide adequate drainage and may cause stormwater runoff to pond in the stormwater planter for extended periods of time. 	<ul style="list-style-type: none"> • Ensure that the underdrain will allow the stormwater planter to drain completely within 24 hours of the end of a rainfall event to prevent the formation of nuisance ponding conditions.
<ul style="list-style-type: none"> • <i>Shallow water table</i> 	<ul style="list-style-type: none"> • May be difficult to provide 2 feet of clearance between the bottom of the stormwater planter and the top of the water table. • May cause stormwater runoff to pond in the stormwater planter. 	<ul style="list-style-type: none"> • Reduce the depth of the planting bed to 18 inches. • Reduce the distance between the bottom of the stormwater planter and top of the water table to 12 inches and provide an adequately sized underdrain. • Use rainwater harvesting (Section 7.8.12), small stormwater wetlands (i.e., pocket wetlands) (Section 8.6.2) or wet swales (Section 8.6.6), instead of stormwater planters to intercept and treat stormwater runoff in these areas.
<ul style="list-style-type: none"> • <i>Tidally-influenced drainage system</i> 	<ul style="list-style-type: none"> • May occasionally prevent stormwater runoff from being conveyed through a stormwater planter, particularly during high tide. 	<ul style="list-style-type: none"> • Investigate the use of other low impact development practices, such as rainwater harvesting (Section 7.8.12) to “receive” stormwater runoff in these areas.

Site Applicability

Stormwater planters are typically used on commercial, institutional and industrial development sites and, because they can be constructed immediately adjacent to buildings and other structures, they are ideal for use in urban areas. Although they are well suited to “receive” rooftop runoff, they can also be used to “receive” stormwater runoff from other small impervious and pervious drainage areas, such as sidewalks, plazas and small parking lots (Figure 7.38). When compared with other low impact development practices, stormwater planters have a relatively high construction cost, a moderate maintenance burden and require a relatively small amount of surface area.

Planning and Design Criteria

It is *recommended* that stormwater planters meet all of the following criteria to be eligible for the stormwater management “credits” described above:

General Planning and Design

- Stormwater planters should be used to “receive” stormwater runoff from small drainage areas of 2,500 square feet or less. The stormwater runoff rates and volumes from larger contributing drainage areas typically become too large to be properly “received” by stormwater planters.

- The length of the flow path within the contributing drainage area should be 150 feet or less for pervious drainage areas and 75 feet or less for impervious drainage areas. In contributing drainage areas with longer flow paths, stormwater runoff tends to become shallow, concentrated flow (Clayton and Schueler, 1996), which can cause soil erosion and can significantly reduce the stormwater management benefits that stormwater planters can provide. In these situations, bioretention areas (Section 7.8.13) should be used to “receive” post-construction stormwater runoff.
- Stormwater planters should be designed to provide enough storage for the stormwater runoff volume generated by the target runoff reduction rainfall event (e.g., 85th percentile rainfall event). Since they are essentially underdrained bioretention areas, the required dimensions of a stormwater planter can be determined using the design procedures provided in Section 8.6.3 of this CSS.
- Stormwater planters should be designed to completely drain within 24 hours of the end of a rainfall event. Where site characteristics allow, it is preferable to design stormwater planters to drain within 12 hours of the end of a rainfall event to help prevent the formation of nuisance ponding conditions.
- Stormwater planters may be designed with a maximum ponding depth of 12 inches, although a ponding depth of 6 inches is recommended to help prevent the formation of nuisance ponding conditions.
- A minimum of 2 inches of freeboard should be provided between the elevation of the maximum ponding depth and the top of the planter box.
- Unless a shallow water table is found on the development site, all stormwater planter planting beds should be at least 24 inches deep. If a shallow water table is found on the development site, the depth of the planting bed may be reduced to 18 inches.
- The soils used within stormwater planter planting beds should be an engineered soil mix that meets the following specifications:
 - Texture: Sandy loam or loamy sand.
 - Sand Content: Soils should contain 85%-88% clean, washed sand.
 - Topsoil Content: Soils should contain 8%-12% topsoil.
 - Organic Matter Content: Soils should contain 3%-5% organic matter.
 - Infiltration Rate: Soils should have an infiltration rate of at least 0.25 inches per hour (in/hr), although an infiltration rate of between 1 and 2 in/hr is preferred.
 - Phosphorus Index (P-Index): Soils should have a P-Index of less than 30.
 - Exchange Capacity (CEC): Soils should have a CEC that exceeds 10 milliequivalents (meq) per 100 grams of dry weight.
 - pH: Soils should have a pH of 6-8.
- The organic matter used within a stormwater planter planting bed should be a well-aged compost that meets the specifications outlined in Section 7.8.1.
- A minimum width, measured from inside wall to inside wall, of 18 inches is recommended for all stormwater planters.
- All stormwater planters should be equipped with a waterproof liner to prevent damage to building foundations and other adjacent impervious surfaces. Waterproof liners should be 30 mil (0.030 inch) polyvinylchloride (PVC) or equivalent.
- Although stormwater planters may be used on development sites with slopes of up to 6%, they should be designed with slopes that are as close to flat as possible to help ensure that stormwater runoff is evenly distributed over the planting bed.
- Stormwater planters should be constructed of stone, concrete, brick or other durable material. Chemically treated wood that can leach toxic chemicals and contaminate stormwater runoff should not be used to construct a stormwater planter.
- Stormwater planters should be equipped with an underdrain consisting of a 4 inch perforated PVC (AASHTO M 252) pipe bedded in a 6 inch layer of clean, washed stone. The pipe should have 3/8 inch perforations, spaced 6 inches on center, and should have

a minimum slope of 0.5%. The clean, washed stone should be ASTM D448 size No. 57 stone (i.e., 1-1/2 to 1/2 inches in size) and should be separated from the planting bed by a layer of permeable filter fabric or a thin, 2 to 4 inch layer of choker stone (i.e., ASTM D 448 size No. 8, 3/8" to 1/8" or ASTM D 448 size No. 89, 3/8" to 1/16"). If permeable filter fabric is used, the filter fabric should be a non-woven geotextile with a permeability that is greater than or equal to the hydraulic conductivity of the overlying planting bed.

- Unless a shallow water table is found on the development site, the distance from the bottom of a stormwater planter to the top of the water table should be at least 2 feet. If a shallow water table is found on the development site, the distance from the bottom of a stormwater planter to the top of the water table may be reduced to 12 inches.
- If used to "receive" non rooftop runoff, stormwater planters should be preceded by a pea gravel diaphragm or equivalent level spreader device (e.g., concrete sills, curb stops, curbs with "sawteeth" cut into them) to intercept stormwater runoff and distribute it evenly, as overland sheet flow, across the stormwater planter.
- Consideration should be given to the stormwater runoff rates and volumes generated by larger storm events (e.g., 25-year, 24-hour storm event) to help ensure that these larger storm events are able to safely bypass the stormwater planter. An overflow system, such as an overdrain with an invert set slightly above the elevation of maximum ponding depth, should be designed to convey the stormwater runoff generated by these larger storm events safely out of the stormwater planter.

Landscaping

- A landscaping plan should be prepared for all stormwater planters. The landscaping plan should be reviewed and approved by the local development review authority prior to construction.
- Vegetation commonly planted in stormwater planters includes native trees, shrubs and other herbaceous vegetation. When developing a landscaping plan, site planning and design teams should choose vegetation that will be able to stabilize soils and tolerate the stormwater runoff rates and volumes that will pass through the stormwater planter. Vegetation used in stormwater planters should also be able to tolerate both wet and dry conditions. See Appendix F of Volume 2 of the *Georgia Stormwater Management Manual* (ARC, 2001) for a list of grasses and other plants that are appropriate for use in stormwater planters in the state of Georgia.
- A mulch layer, consisting of 2-4 inches of fine shredded hardwood mulch or shredded hardwood chips, should be included on the surface of the stormwater planter.
- Methods used to establish vegetative cover within a stormwater planter should achieve at least 75 percent vegetative cover one year after installation.
- To help prevent soil erosion and sediment loss, landscaping should be provided immediately after the stormwater planter has been installed. Temporary irrigation may be needed to quickly establish vegetative cover within a stormwater planter.

Construction Considerations

To help ensure that stormwater planters are successfully installed on a development site, site planning and design teams should consider the following recommendations:

- If stormwater planters will be used to "receive" non rooftop runoff, they should only be installed after their contributing drainage areas have been completely stabilized.
- Simple erosion and sediment control measures, such as temporary seeding and erosion control mats, should be used within the stormwater planter. Appropriate measures should be taken (e.g., temporary diversion) to divert post-construction stormwater runoff around a stormwater planter until vegetative cover has been established.

- To help prevent soil compaction, heavy vehicular and foot traffic should be kept out of stormwater planters during and after construction.
- Construction contracts should contain a replacement warranty that covers at least three growing seasons to help ensure adequate growth and survival of the vegetation planted within a stormwater planter.

Maintenance Requirements

Maintenance is very important for stormwater planters, particularly in terms of ensuring that they continue to provide measurable stormwater management benefits over time. Consequently, a legally binding inspection and maintenance agreement and plan should be created to help ensure that they are properly maintained after construction is complete. Table 7.31 provides a list of the routine maintenance activities typically associated with stormwater planters. It is important to note that rain gardens have maintenance requirements that are very similar to those of other vegetated low impact development practices.

Activity	Schedule
<ul style="list-style-type: none"> • Water to promote plant growth and survival. • Inspect stormwater planter following rainfall events. Plant replacement vegetation in any eroded areas. 	As Needed (Following Construction)
<ul style="list-style-type: none"> • Prune and weed stormwater planter. • Remove accumulated trash and debris. 	Monthly (At a Minimum)
<ul style="list-style-type: none"> • Inspect inflow and outflow areas for sediment accumulation. Remove any accumulated sediment or debris. • Inspect stormwater planter for erosion and the formation of rills and gullies. Plant replacement vegetation in any eroded areas. • Inspect stormwater planter for dead or dying vegetation. Plant replacement vegetation as needed. • Replace mulch. 	Annually (Semi-Annually During First Year)

Additional Resources

City of Portland, OR. 2008. "Planter." *Portland Stormwater Management Manual*. Section 2.3.3.
 City of Portland, OR. Bureau of Environmental Services. Available Online:
<http://www.portlandonline.com/bes/index.cfm?c=47952>.

Atlanta Regional Commission (ARC). 2001. "Bioretention Areas." *Georgia Stormwater Management Manual*. Volume 2. Technical Handbook. Section 3.2.3. Atlanta Regional Commission. Atlanta, GA. Available Online: <http://www.georgia-stormwater.com/>.

7.8.11 Dry Wells

Description

Dry wells are low impact development practices that are located below the surface of development sites. They consist of shallow excavations, typically filled with stone, that are designed to intercept and temporarily store post-construction stormwater runoff until it infiltrates into the underlying and surrounding soils. If properly designed, they can provide significant reductions in post-construction stormwater runoff rates, volumes and pollutant loads on development sites. Consequently, dry wells can be used to help satisfy the SWM Criteria presented in this CSS.

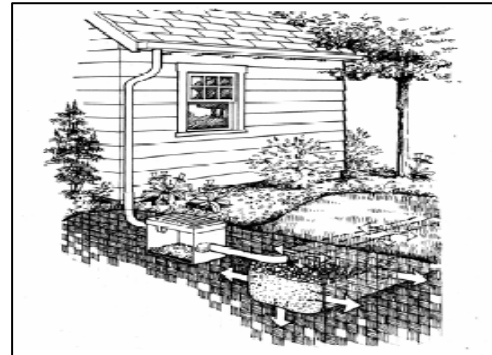

(Source: City of Portland, OR, 2008)

<p style="text-align: center;"><u>KEY CONSIDERATIONS</u></p> <p>DESIGN CRITERIA:</p> <ul style="list-style-type: none"> • Dry wells should be designed to completely drain within 24 hours of the end of a rainfall event • The distance from the bottom of a dry well to the top of the water table should be least 2 feet • Dry wells should be designed with slopes that are as close to flat as possible to help ensure that stormwater runoff is evenly distributed throughout the stone reservoir <p>BENEFITS:</p> <ul style="list-style-type: none"> • Helps restore pre-development hydrology on development sites and reduces post-construction stormwater runoff rates, volumes and pollutant loads • Particularly well suited for use on urban development sites <p>LIMITATIONS:</p> <ul style="list-style-type: none"> • Can only be used to “receive” runoff from small drainage areas of 2,500 square feet or less • Should not be used on development sites that have soils with infiltration rates of less than 0.5 inches per hour 	<p style="text-align: center;"><u>STORMWATER MANAGEMENT “CREDITS”</u></p> <ul style="list-style-type: none"> <input checked="" type="checkbox"/> Runoff Reduction <input checked="" type="checkbox"/> Water Quality Protection <input checked="" type="checkbox"/> Aquatic Resource Protection <input checked="" type="checkbox"/> Overbank Flood Protection <input checked="" type="checkbox"/> Extreme Flood Protection <p><input checked="" type="checkbox"/> = practice has been assigned quantifiable stormwater management “credits” that can be used to address this SWM Criteria</p>						
<p style="text-align: center;"><u>SITE APPLICABILITY</u></p> <table border="0"> <tr> <td><input checked="" type="checkbox"/> Rural Use</td> <td><input type="checkbox"/> Construction Cost</td> </tr> <tr> <td><input checked="" type="checkbox"/> Suburban Use</td> <td><input type="checkbox"/> Maintenance</td> </tr> <tr> <td><input checked="" type="checkbox"/> Urban Use</td> <td><input type="checkbox"/> Area Required</td> </tr> </table>	<input checked="" type="checkbox"/> Rural Use	<input type="checkbox"/> Construction Cost	<input checked="" type="checkbox"/> Suburban Use	<input type="checkbox"/> Maintenance	<input checked="" type="checkbox"/> Urban Use	<input type="checkbox"/> Area Required	<p style="text-align: center;"><u>STORMWATER MANAGEMENT PRACTICE PERFORMANCE</u></p> <p>Runoff Reduction 80% - Annual Runoff Volume Varies¹ - Runoff Reduction Volume</p> <p>Pollutant Removal² 80% - Total Suspended Solids 80% - Total Phosphorus 80% - Total Nitrogen 80% - Metals 80% - Pathogens</p> <p>1 = varies according to storage capacity of the dry well 2 = expected annual pollutant load removal</p>
<input checked="" type="checkbox"/> Rural Use	<input type="checkbox"/> Construction Cost						
<input checked="" type="checkbox"/> Suburban Use	<input type="checkbox"/> Maintenance						
<input checked="" type="checkbox"/> Urban Use	<input type="checkbox"/> Area Required						

Discussion

Dry wells (also known as *seepage pits* and *french drains*) are low impact development practices that are located below the surface of development sites. They consist of shallow excavations, typically filled with stone, that are designed to intercept and temporarily store post-construction stormwater runoff until it infiltrates into the underlying and surrounding soils (Figure 7.40). If properly designed, they can provide significant reductions in post-construction stormwater runoff rates, volumes and pollutant loads on development sites.

As infiltration-based low impact development practices, dry wells are limited to use in areas where the soils are permeable enough and the water table is low enough to provide for the infiltration of stormwater runoff. They should only be considered for use on development sites where fine sediment (e.g., clay, silt) loads will be relatively low, as high sediment loads will cause them to clog and fail. In addition, dry wells should be carefully sited to avoid the potential contamination of water supply aquifers.

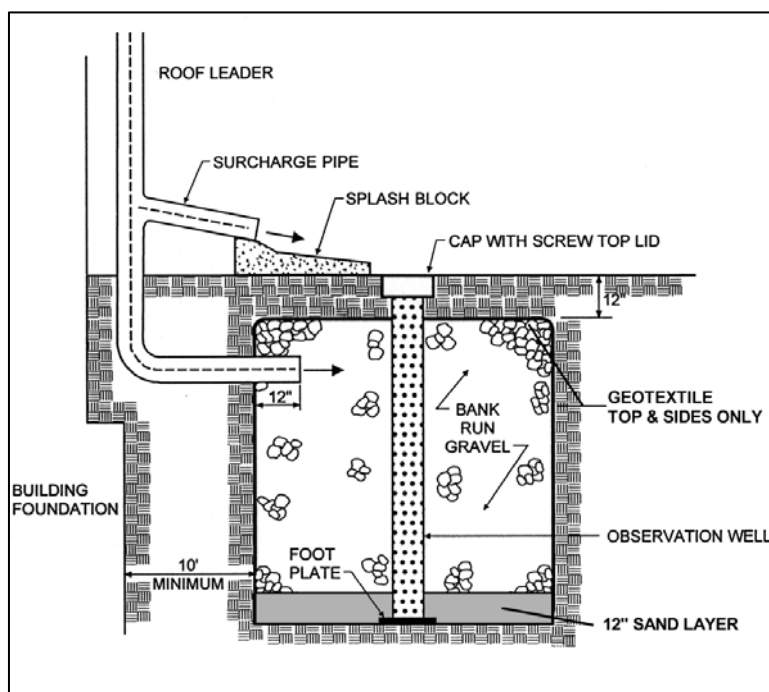

Figure 7.40: Dry Well

(Source: Maryland Department of the Environment, 2000)

The primary concern associated with the design of a dry well is its storage capacity, which directly influences its ability to reduce stormwater runoff rates, volumes and pollutant loads. Site planning and design teams should strive to design dry wells that can accommodate the stormwater runoff volume generated by the target runoff reduction rainfall event (e.g., 85th percentile rainfall event). If this cannot be accomplished, due to site characteristics or constraints, site planning and design teams should consider using dry wells in combination with other runoff reducing low impact development practices, such as rain gardens (Section 7.8.9) and rainwater harvesting (Section 7.8.12), to supplement the stormwater management benefits provided by the dry wells.

Stormwater Management “Credits”

The Center for Watershed Protection (Hirschman et al., 2008) recently documented the ability of dry wells to reduce annual stormwater runoff volumes and pollutant loads on development sites. Consequently, this low impact development practice has been assigned quantifiable stormwater management “credits” that can be used to help satisfy the SWM Criteria presented in this CSS:

- **Stormwater Runoff Reduction:** Subtract 100% of the storage volume provided by a *dry well* from the runoff reduction volume (RR_v) conveyed through the *dry well*.
- **Water Quality Protection:** Subtract 100% of the storage volume provided by a *dry well* from the runoff reduction volume (RR_v) conveyed through the *dry well*.

- Aquatic Resource Protection: Proportionally adjust the post-development runoff curve number (CN) to account for the runoff reduction provided by a *dry well* when calculating the aquatic resource protection volume (ARP_v) on a development site.
- Overbank Flood Protection: Proportionally adjust the post-development runoff curve number (CN) to account for the runoff reduction provided by a *dry well* when calculating the overbank peak discharge (Q_{p25}) on a development site.
- Extreme Flood Protection: Proportionally adjust the post-development runoff curve number (CN) to account for the runoff reduction provided by a *dry well* when calculating the extreme peak discharge (Q_{p100}) on a development site.

The storage volume provided by a dry well can be determined using the following equation:

$$\text{Storage Volume} = \text{Surface Area} \times \text{Depth} \times \text{Void Ratio}$$

A void ratio (i.e., void space/total volume) of 0.32 should be used in all storage volume calculations, unless more specific planting bed void ratio data are available.

In order to “receive” stormwater runoff and be eligible for these “credits,” it is *recommended* that dry wells satisfy the planning and design criteria outlined below.

Overall Feasibility

The criteria listed in Table 7.32 should be evaluated to determine whether or not a dry well is appropriate for use on a development site.

Table 7.32: Factors to Consider When Evaluating the Overall Feasibility of Using a Dry Well on a Development Site	
Site Characteristic	Criteria
Drainage Area	The size of the contributing drainage area should be 2,500 square feet or less. The length of flow path in contributing drainage areas should be 150 feet or less in pervious drainage areas and 75 feet or less in impervious drainage areas.
Area Required	Dry well surface area requirements vary according to the size of the contributing drainage area and the infiltration rate of the soils on which the dry well will be located. In general, dry wells require about 5-10% of the size of their contributing drainage areas.
Slope	Although dry wells may be used on development sites with slopes of up to 6%, they should be designed with slopes that are as close to flat as possible to help ensure that stormwater runoff is evenly distributed throughout the stone reservoir.
Minimum Head	2 feet
Minimum Depth to Water Table	2 feet
Soils	Dry wells should be designed to completely drain within 24 hours of the end of a rainfall event. Consequently, dry wells generally should not be used on development sites that have soils with infiltration rates of less than 0.50 inches per hour (i.e., hydrologic soil group C and D soils).

Feasibility in Coastal Georgia

Several site characteristics commonly encountered in coastal Georgia may present challenges to site planning and design teams that are interested in using dry wells to “receive” post-construction stormwater runoff on a development site. Table 7.33 identifies these common site characteristics and describes how they influence the use of dry wells on development sites. The table also provides site planning and design teams with some ideas about how they can work around these potential constraints.

Site Characteristic	How it Influences the Use of Dry Wells	Potential Solutions
<ul style="list-style-type: none"> <i>Poorly drained soils</i>, such as hydrologic soil group C and D soils 	<ul style="list-style-type: none"> Reduces the ability of dry wells to reduce stormwater runoff rates, volumes and pollutant loads. 	<ul style="list-style-type: none"> Dry wells should not be used on development sites that have soils with infiltration rates of less than 0.5 inches per hour (i.e., hydrologic soil group C and D soils). Use other low impact development practices, such as rainwater harvesting (Section 7.8.12) and underdrained bioretention areas (Section 7.8.13), to “receive” stormwater runoff in these areas.
<ul style="list-style-type: none"> <i>Well drained soils</i>, such as hydrologic soil group A and B soils 	<ul style="list-style-type: none"> Enhances the ability of dry wells to reduce stormwater runoff rates, volumes and pollutant loads, but may allow stormwater pollutants to reach groundwater aquifers with greater ease. 	<ul style="list-style-type: none"> Rooftop runoff is relatively clean, so this should not prevent the use of dry wells, even at stormwater hotspots and in areas known to provide groundwater recharge to water supply aquifers. However, rooftop runoff should not be allowed to comingle with runoff from other impervious surfaces in these areas if it will be “received” by a dry well. Use bioretention areas (Section 7.8.13) and dry swales (Section 7.8.15) with liners and underdrains to intercept and treat non rooftop runoff at stormwater hotspots and in areas known to provide groundwater recharge to water supply aquifers.
<ul style="list-style-type: none"> <i>Flat terrain</i> 	<ul style="list-style-type: none"> Does not influence the use of dry wells. In fact, dry wells should be designed with slopes that are as close to flat as possible. 	

Table 7.33: Challenges Associated with Using Dry Wells in Coastal Georgia

Site Characteristic	How it Influences the Use of Dry Wells	Potential Solutions
<ul style="list-style-type: none"> <i>Shallow water table</i> 	<ul style="list-style-type: none"> May be difficult to provide 2 feet of clearance between the bottom of the dry well and the top of the water table. May occasionally cause stormwater runoff to pond in the bottom of the dry well. 	<ul style="list-style-type: none"> Ensure that the distance from the bottom of the dry well to the top of the water table is at least 2 feet. Reduce the depth of the stone reservoir in dry wells to 18 inches. Use rainwater harvesting (Section 7.8.12), small stormwater wetlands (i.e., pocket wetlands) (Section 8.6.2) or wet swales (Section 8.6.6), instead of dry wells to intercept and treat stormwater runoff in these areas.
<ul style="list-style-type: none"> <i>Tidally-influenced drainage system</i> 	<ul style="list-style-type: none"> Does not influence the use of dry wells. 	

Site Applicability

Dry wells can be used to “receive” stormwater runoff on a wide variety of development sites, including residential, commercial and institutional development sites in rural, suburban and urban areas. Although they are particularly well suited to “receive” rooftop runoff, they can also be used to “receive” stormwater runoff from other small drainage areas, such as local streets and roadways, driveways, small parking areas and disturbed pervious areas (e.g., lawns, parks, community open spaces). When compared with other low impact development practices, dry wells have a moderate construction cost, a moderate maintenance burden and require only a small amount of surface area.

Planning and Design Criteria

It is *recommended* that dry wells meet all of the following criteria to be eligible for the stormwater management “credits” described above:

General Planning and Design

- Dry wells should be used to “receive” stormwater runoff from small drainage areas of 2,500 square feet or less. The stormwater runoff rates and volumes from larger contributing drainage areas typically become too large to be properly “received” by a dry well.
- The length of the flow path within the contributing drainage area should be 150 feet or less for pervious drainage areas and 75 feet or less for impervious drainage areas. In contributing drainage areas with longer flow paths, stormwater runoff tends to become shallow, concentrated flow (Clayton and Schueler, 1996), which can significantly reduce the stormwater management benefits that dry wells can provide. In these situations, bioretention areas (Section 7.8.13) and infiltration practices (Section 7.8.14) should be used to “receive” post-construction stormwater runoff.
- Although dry wells may be installed on development sites with slopes of up to 6%, they should be designed with slopes that are as close to flat as possible to help ensure that stormwater runoff is evenly distributed throughout the stone reservoir.
- Dry wells should be located in a lawn or other disturbed pervious area and should be designed so that the top of the dry well is located as close to the surface as possible. Dry wells should not be located beneath a driveway, parking lot or other impervious surface.

- Dry wells should be used on development sites that have underlying soils with an infiltration rate of 0.50 inches per hour (in/hr) or greater, as determined by NRCS soil survey data and subsequent field testing. Field infiltration test protocol, such as that provided by the City of Portland, OR (Portland, OR, 2008) on the following website: <http://www.portlandonline.com/shared/cfm/image.cfm?id= 202911>, can be used to conduct field testing, but should be approved by the local development review authority prior to use.
- Although the number of infiltration tests needed on a development site will ultimately be determined by the local development review authority, at least one infiltration test is recommended for each dry well that will be used on the development site.
- Since clay lenses or any other restrictive layers located below the bottom of a dry well will reduce soil infiltration rates, infiltration testing should be conducted within any confining layers that are found within 4 feet of the bottom of a proposed dry well.
- Dry wells should be designed to provide enough storage for the stormwater runoff volume generated by the target runoff reduction rainfall event (e.g., 85th percentile rainfall event). Since they are essentially infiltration practices, the required dimensions of a dry well can be determined using the design procedures provided in Section 8.6.5 of this CSS.
- Dry wells should be designed to completely drain within 24 hours of the end of a rainfall event. Where site characteristics allow, it is preferable to design dry wells to drain within 12 hours of the end of a rainfall event to help prevent the formation of nuisance ponding conditions.
- Broader, shallower dry wells perform more effectively by distributing stormwater runoff over a larger surface area. However, a minimum depth of 18 inches is recommended for all dry well designs to prevent them from consuming a large amount of surface area on development sites. Whenever practical, the depth of dry wells should be kept to 36 inches or less.
- Dry wells should be filled with clean, washed stone. The stone used in the dry well should be 1.5 to 2.5 inches in diameter, with a void space of approximately 40% (e.g., GA DOT No. 3 Stone). Unwashed aggregate contaminated with soil or other fines may not be used in the dry well.
- Underlying native soils should be separated from the dry well stone by a thin, 2 to 4 inch layer of choker stone (i.e., ASTM D 448 size No. 8, 3/8" to 1/8" or ASTM D 448 size No. 89, 3/8" to 1/16"). The choker stone should be placed between the dry well stone and the underlying native soils.
- The top and sides of the dry well should be lined with a layer of appropriate permeable filter fabric. The filter fabric should be a non-woven geotextile with a permeability that is greater than or equal to the infiltration rate of the surrounding native soils. The top layer of the filter fabric should be located 6 inches from the top of the excavation, with the remaining space filled with appropriate landscaping. This top layer serves as a sediment barrier and, consequently, will need to be replaced over time. Site planning and design teams should ensure that the top layer of filter fabric can be readily separated from the filter fabric used to line the sides of the dry well.
- The depth from the bottom of a dry well to the top of the water table should be at least 2 feet to prevent nuisance ponding and ensure proper operation of the dry well.
- To prevent damage to building foundations and contamination of groundwater aquifers, dry wells should be located at least:
 - 10 feet from building foundations
 - 10 feet from property lines
 - 100 feet from private water supply wells
 - 1,200 feet from public water supply wells
 - 100 feet from septic systems

- 100 feet from surface waters
 - 400 feet from public water supply surface waters
- An observation well should be installed in every dry well. An observation well consists of a 4 to 6 inch perforated PVC (AASHTO M 252) pipe that extends to the bottom of the dry well. The observation well can be used to observe the rate of drawdown within the dry well following a storm event. It should be installed along the centerline of the dry well, flush with the elevation of the surface of the dry well. A visible floating marker should be provided within the observation well and the top of the well should be capped and locked to prevent tampering and vandalism. Appendix B in Volume 2 of the *Georgia Stormwater Management Manual* provides additional information about observation wells.
- If used to “receive” rooftop runoff, dry wells should be preceded by a leaf screen installed in the gutter or downspout. This will prevent leaves and other large debris from clogging the dry well.
- If used to “receive” non rooftop runoff, dry wells should be preceded by a pea gravel diaphragm or equivalent level spreader device (e.g., concrete sills, curb stops, curbs with “sawteeth” cut into them) and a vegetated filter strip that is designed according to the planning and design criteria provided in Section 7.8.6 of this CSS.
- Consideration should be given to the stormwater runoff rates and volumes generated by larger storm events (e.g., 25-year, 24-hour storm event) to help ensure that these larger storm events are able to safely bypass the dry well. An overflow, such as a vegetated filter strip (Section 7.8.6) or grass channel (Section 7.8.7), should be designed to convey the stormwater runoff generated by these larger storm events safely out of the dry well.

Landscaping

- The landscaped area above the surface of a dry well may be covered with pea gravel (i.e., ASTM D 448 size No. 8, 3/8” to 1/8”). This pea gravel layer provides sediment removal and additional pretreatment upstream of the dry well and can be easily removed and replaced when it becomes clogged.
- Alternatively, a dry well may be covered with an engineered soil mix, such as that prescribed in Section 7.8.9 of this CSS, and planted with managed turf or other herbaceous vegetation. This may be an attractive option when dry wells are placed in disturbed pervious areas (e.g., lawns, parks, community open spaces).

Construction Considerations

To help ensure that dry wells are successfully installed on a development site, site planning and design teams should consider the following recommendations:

- If dry wells will be used to “receive” non rooftop runoff, they should only be installed after their contributing drainage areas have been completely stabilized. To help prevent dry well failure, stormwater runoff may be diverted around the dry well until the contributing drainage area has been stabilized.
- To help prevent soil compaction, heavy vehicular and foot traffic should be kept out of dry wells before, during and immediately after construction. This can typically be accomplished by clearly delineating dry wells on all development plans and, if necessary, protecting them with temporary construction fencing.
- Excavation for dry wells should be limited to the width and depth specified in the development plans. Excavated material should be placed away from the excavation so as not to jeopardize the stability of the side walls.
- The native soils along the bottom of the dry well should be scarified or tilled to a depth of 3 to 4 inches prior to the placement of the choker stone and dry well stone.

- The sides of all excavations should be trimmed of all large roots that will hamper the installation of the permeable filter fabric used to line the sides and top of the dry well.

Maintenance Requirements

Maintenance is important for dry wells, particularly in terms of ensuring that they continue to provide measurable stormwater management benefits over time. Consequently, a legally-binding inspection and maintenance agreement and plan should be put in place to ensure that dry wells are regularly maintained after occupancy. Table 7.34 provides a list of the routine maintenance activities typically associated with dry wells.

Activity	Schedule
<ul style="list-style-type: none"> • If used to "receive" non rooftop runoff, ensure that the contributing drainage area is stabilized prior to installation of the dry well. • If applicable, water to promote plant growth and survival within landscaped area over the top of the dry well. • If applicable, inspect vegetative cover on the surface of the dry well following rainfall events. Plant replacement vegetation in any eroded areas. 	<p style="text-align: center;">As Needed (During Construction)</p>
<ul style="list-style-type: none"> • If applicable, inspect gutters and downspouts. Remove any accumulated leaves or debris. • Inspect dry well following rainfall events. Check observation well to ensure that complete drawdown has occurred within 72 hours after the end of a rainfall event. Failure to drawdown within this timeframe may indicate dry well failure. • If applicable, inspect pretreatment devices for sediment accumulation. Remove accumulated trash and debris. • Inspect top layer of filter fabric for sediment accumulation. Remove and replace if clogged. 	<p style="text-align: center;">Annually (Semi-Annually During First Year)</p>
<ul style="list-style-type: none"> • Perform total rehabilitation of the dry well, removing dry well stone and excavating to expose clean soil on the sides and bottom of the well. 	<p style="text-align: center;">Upon Failure</p>

Additional Resources

City of Portland, OR. 2008. "Soakage Trench." *Portland Stormwater Management Manual*. Section 2.3.3. City of Portland, OR. Bureau of Environmental Services. Available Online: <http://www.portlandonline.com/bes/index.cfm?c=47952>.

City of Portland, OR. 2008. "Dry Well." *Portland Stormwater Management Manual*. Section 2.3.3. City of Portland, OR. Bureau of Environmental Services. Available Online: <http://www.portlandonline.com/bes/index.cfm?c=47952>.

Atlanta Regional Commission (ARC). 2001. "Infiltration Trench." *Georgia Stormwater Management Manual*. Volume 2. Technical Handbook. Section 3.2.5. Atlanta Regional Commission. Atlanta, GA. Available Online: <http://www.georgia-stormwater.com/>.

7.8.12 Rainwater Harvesting

Description

Rainwater harvesting is the ancient stormwater management practice of intercepting, diverting and storing rainfall for later use. In a typical rainwater harvesting system, rainfall is collected from a gutter and downspout system, screened and “washed,” and conveyed into an above- or below-ground storage tank or cistern. Once captured in the storage tank or cistern, it may be used for non-potable indoor or outdoor uses. If properly designed, rainwater harvesting systems can significantly reduce post-construction stormwater runoff rates, volumes and pollutant loads on development sites. Rainwater harvesting also helps reduce the demand on public water supplies, which, in turn, helps protect aquatic resources, such as groundwater aquifers, from drawdown and seawater intrusion.



(Source: Jones and Hunt. 2008)

<p style="text-align: center;"><u>KEY CONSIDERATIONS</u></p> <p>DESIGN CRITERIA:</p> <ul style="list-style-type: none"> • Rainwater harvesting systems should be sized based on the size of the contributing drainage area, local rainfall patterns and the projected demand for the harvested rainwater • Pretreatment should be provided upstream of all rainwater harvesting systems to prevent leaves and other debris from clogging the system <p>BENEFITS:</p> <ul style="list-style-type: none"> • Helps restore pre-development hydrology on development sites and reduces post-construction stormwater runoff rates, volumes and pollutant loads • Can be used on nearly any development site • Reduces demand on public water supplies, which helps protect groundwater aquifers from drawdown and seawater intrusion <p>LIMITATIONS:</p> <ul style="list-style-type: none"> • Rain barrels may not be used except on small drainage areas of 2,500 square feet or less • Stored rainwater should be used on a regular basis to maintain system storage capacity 	<p style="text-align: center;"><u>STORMWATER MANAGEMENT “CREDITS”</u></p> <ul style="list-style-type: none"> <input checked="" type="checkbox"/> Runoff Reduction <input checked="" type="checkbox"/> Water Quality Protection <input checked="" type="checkbox"/> Aquatic Resource Protection <input checked="" type="checkbox"/> Overbank Flood Protection <input checked="" type="checkbox"/> Extreme Flood Protection <p><input checked="" type="checkbox"/> = practice has been assigned quantifiable stormwater management “credits” that can be used to address this SWM Criteria</p>						
<p style="text-align: center;"><u>SITE APPLICABILITY</u></p> <table border="0"> <tr> <td><input checked="" type="checkbox"/> Rural Use</td> <td><input type="checkbox"/> Construction Cost</td> </tr> <tr> <td><input checked="" type="checkbox"/> Suburban Use</td> <td><input type="checkbox"/> Maintenance</td> </tr> <tr> <td><input checked="" type="checkbox"/> Urban Use</td> <td><input type="checkbox"/> Area Required</td> </tr> </table>	<input checked="" type="checkbox"/> Rural Use	<input type="checkbox"/> Construction Cost	<input checked="" type="checkbox"/> Suburban Use	<input type="checkbox"/> Maintenance	<input checked="" type="checkbox"/> Urban Use	<input type="checkbox"/> Area Required	<p style="text-align: center;"><u>STORMWATER MANAGEMENT PRACTICE PERFORMANCE</u></p> <p>Runoff Reduction Varies¹ - Annual Runoff Volume Varies¹ - Runoff Reduction Volume</p> <p>Pollutant Removal² Varies¹ - Total Suspended Solids Varies¹ - Total Phosphorus Varies¹ - Total Nitrogen Varies¹ - Metals N/A - Pathogens</p> <p>1 = varies according to storage capacity of the rainwater harvesting system 2 = expected annual pollutant load removal</p>
<input checked="" type="checkbox"/> Rural Use	<input type="checkbox"/> Construction Cost						
<input checked="" type="checkbox"/> Suburban Use	<input type="checkbox"/> Maintenance						
<input checked="" type="checkbox"/> Urban Use	<input type="checkbox"/> Area Required						

Discussion

Rainwater harvesting is the ancient stormwater management practice of intercepting, diverting and storing rainfall for later use. In a typical rainwater harvesting system (Figure 7.41), rainfall is collected from a gutter and downspout system, screened and “washed,” and conveyed into an above- or below-ground storage tank or cistern. Once captured in the storage tank or cistern, it may be used for non-potable indoor or outdoor uses. If properly designed, rainwater harvesting systems can significantly reduce post-construction stormwater runoff rates, volumes and pollutant loads on development sites.

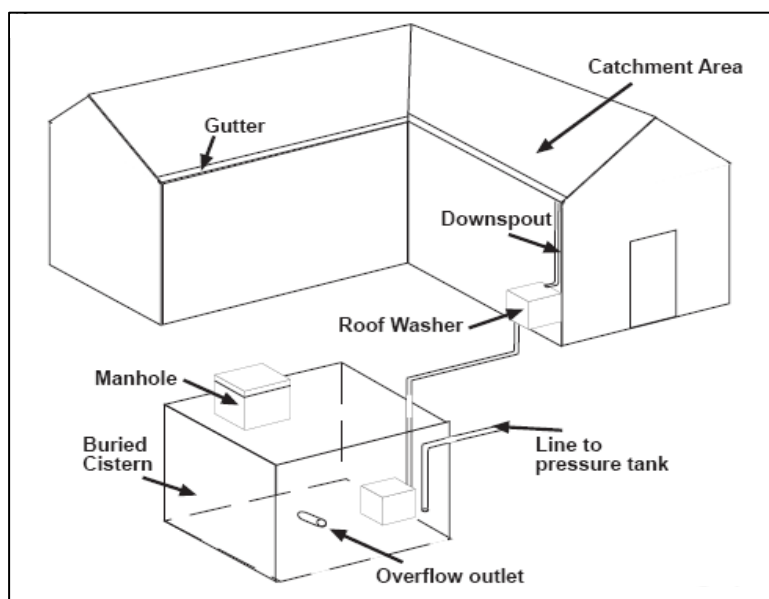

Figure 7.41: Rainwater Harvesting System

(Source: Rupp, 1998)

There are two basic types of rainwater harvesting systems: (1) systems that are used to supply water for non-potable outdoor uses, such as landscape irrigation, car and building washing and fire fighting; and (2) systems that are used to supply water for non-potable indoor uses, such as laundry and toilet flushing. Rainwater harvesting systems used to supply water for non-potable indoor uses are more complex and require separate plumbing, pressure tanks, pumps and backflow preventers. Additionally, the use of harvested rainwater for non-potable indoor uses may be restricted in some areas of coastal Georgia, due to existing “development rules.” Developers and their site planning and design teams are encouraged to consult with the local development review authority if they are interested in using harvested rainwater for non-potable indoor uses.

Whether it is used to supply water for non-potable indoor or outdoor uses, a well-designed rainwater harvesting system typically consists of five major components (Figure 7.42), including the collection and conveyance system (e.g., gutter and downspout system), pretreatment devices (e.g., leaf screens, first flush diverters, roof washers), the storage tank or cistern, the overflow pipe (which allows excess stormwater runoff to bypass the storage tank or cistern) and the distribution system (which may or may not require a pump, depending on site characteristics). When designing a rainwater harvesting system, site planning and design teams should consider each of these components, as well as the size of the contributing drainage area, local rainfall patterns and the projected water demand, to determine how large the cistern or storage tank must be to provide enough water for the desired



Figure 7.42: Major Components of a Rainwater Harvesting System

(Source: Jones and Hunt, 2008)

non-potable indoor or outdoor use.

Stormwater Management “Credits”

The Center for Watershed Protection (Hirschman et al., 2008) recently documented the ability of rainwater harvesting systems to reduce annual stormwater runoff volumes and pollutant loads on development sites. Consequently, this low impact development practice has been assigned quantifiable stormwater management “credits” that can be used to help satisfy the SWM Criteria presented in this CSS:

- Stormwater Runoff Reduction: Subtract 75% of the storage volume provided by a *rainwater harvesting system* from the runoff reduction volume (RR_v) captured by the *system*.
- Water Quality Protection: Subtract 75% of the storage volume provided by a *rainwater harvesting system* from the runoff reduction volume (RR_v) captured by the *system*.
- Aquatic Resource Protection: Proportionally adjust the post-development runoff curve number (CN) to account for the runoff reduction provided by a *rainwater harvesting system* when calculating the aquatic resource protection volume (ARP_v) on a development site.
- Overbank Flood Protection: Proportionally adjust the post-development runoff curve number (CN) to account for the runoff reduction provided by a *rainwater harvesting system* when calculating the overbank peak discharge (Q_{p25}) on a development site.
- Extreme Flood Protection: Proportionally adjust the post-development runoff curve number (CN) to account for the runoff reduction provided by a *rainwater harvesting system* when calculating the extreme peak discharge (Q_{p100}) on a development site.

Only 75% of the storage volume provided by a rainwater harvesting system can be subtracted from the runoff reduction volume (RR_v) that is captured by the system due to the fact that some of the harvested rainwater may not be used between consecutive storm events.

In order to “receive” stormwater runoff and be eligible for these “credits,” it is *recommended* that rainwater harvesting systems satisfy the planning and design criteria outlined below.

Overall Feasibility

The criteria listed in Table 7.35 should be evaluated to determine whether or not a rainwater harvesting system is appropriate for use on a development site. It is important to note that rainwater harvesting systems have few constraints that impede their use on development sites.

Table 7.35: Factors to Consider When Evaluating the Overall Feasibility of Using a Rainwater Harvesting System on a Development Site	
Site Characteristic	Criteria
Drainage Area	No restrictions
Area Required	Varies according to the size of the contributing drainage area and the dimensions of the rain tank or cistern used to store the harvested rainwater.
Slope	No restrictions, although placing rainwater harvesting systems at higher elevations may reduce or eliminate pumping requirements.
Minimum Head	N/A

Table 7.35: Factors to Consider When Evaluating the Overall Feasibility of Using a Rainwater Harvesting System on a Development Site

Site Characteristic	Criteria
Minimum Depth to Water Table	N/A
Soils	N/A

Site Applicability

Rainwater harvesting systems can be used on a wide variety of development sites in rural, suburban and urban areas. They are especially well suited for use on commercial, institutional, municipal and multi-family residential buildings on urban and suburban development and redevelopment sites. When compared with other low impact development practices, rainwater harvesting systems have a moderate construction cost, a relatively high maintenance burden and require a relatively small amount of surface area. Although they can be expensive to install, rainwater harvesting systems are often a component of “green buildings,” such as those that achieve certification in the Leadership in Energy and Environmental Design (LEED) Green Building Rating System.

Planning and Design Criteria

It is *recommended* that rainwater harvesting systems meet all of the following criteria to be eligible for the stormwater management “credits” described above:

General Planning and Design

- Rainwater harvesting systems may be installed on nearly any development site. However, placing storage tanks or cisterns at higher elevations may reduce or eliminate pumping requirements.
- The quality of harvested rainwater will vary according to the material from which the rooftop is constructed. Water harvested from certain types of rooftops, such as asphalt shingle, tar and gravel and treated wood shingle roofs, should only be used for non-potable outdoor uses, as these materials may leach toxic compounds into stormwater runoff.
- Rainwater harvesting systems should be designed to provide at least enough storage for the stormwater runoff volume generated by the target runoff reduction rainfall event (e.g., 85th percentile rainfall event). The required size of a rainwater harvesting system is governed by several factors, including the size of the contributing drainage area, local rainfall patterns and the projected demand for the harvested rainwater. Site planning and design teams should calculate the projected water demand and then conduct water balance calculations, based on the size of the contributing drainage area and local precipitation data, to size a rainwater harvesting system. A rainwater harvesting model, such as the one provided by North Carolina State University (NCSU, 2008) on the following website: <http://www.bae.ncsu.edu/topic/waterharvesting>, can be used to design a rainwater harvesting system, provided that the precipitation data being used in the model reflects local rainfall patterns and distributions and has been approved by the local development review authority prior to use.
- Since it provides storage for the harvested rainwater, the storage tank (also known as a *cistern*) is the most important and typically the most expensive component of a rainwater harvesting system. Storage tanks can be constructed from a variety of materials, including wood, plastic, fiberglass or galvanized metal. Site planning and design teams should choose an appropriate cistern for the intended application and should ensure that it has been sealed with a water safe, non-toxic substance.
- Rain barrels (i.e., small storage tanks capable of storing less than 100 gallons of stormwater runoff) rarely provide enough storage capacity to accommodate the

stormwater runoff volume generated by the target runoff reduction rainfall event. Consequently, they should not be used as part of a rainwater harvesting system, except on small drainage areas of 2,500 square feet or less in size.

- All storage tanks should be opaque or otherwise protected from direct sunlight to inhibit algae growth. They should also be screened to discourage mosquito breeding and reproduction, but should be accessible for cleaning, inspection and maintenance.
- Rooftop drainage systems (e.g., gutter and downspout systems) should be designed as they would be for a building designed without a rainwater harvesting system. Drainage system components leading to the cistern should have a minimum slope of 2% to ensure that harvested rainwater is actually conveyed into the storage tank.
- Pretreatment is needed to remove debris, dust, leaves and other material that accumulates on rooftops, as it may cause clogging within a rainwater harvesting system. Pretreatment devices that may be used include leaf screens, roof washers and first-flush diverters, each of which are described briefly below:
 - Leaf Screens: Leaf screens are mesh screens installed either in the gutter or downspout that are used to remove leaves and other large debris from rooftop runoff. Leaf screens must be regularly cleaned to be effective. If not regularly maintained, they can become clogged and prevent rainwater from flowing into the storage tank.
 - First Flush Diverters: First flush diverters direct the initial pulse of stormwater runoff away from the storage tank and into an adjacent pervious area. While leaf screens effectively remove larger debris such as leaves and twigs from harvested rainwater, first flush diverters can be used to remove smaller contaminants such as dust, pollen and bird and rodent feces.
 - Roof Washers: Roof washers are placed just ahead of storage tanks and are used to filter small debris from the harvested rainwater. Roof washers consist of a small tank, usually between 25 and 50 gallons in size, with leaf strainers and filters with openings as small as 30 microns (TWDB, 2005). The filter functions to remove very small particulate matter from harvested rainwater. All roof washers must be cleaned on a regular basis. Without regular maintenance, they may not only become clogged and prevent rainwater from entering the storage tank, but may become breeding grounds for bacteria and other pathogens.
- An overflow pipe should be provided to allow stormwater runoff to bypass the storage tank or cistern when it reaches its storage capacity. The overflow pipe should have a conveyance capacity that is equal to or greater than that of the inflow pipe and should direct excess stormwater runoff to another low impact development practice, such as a vegetated filter strip (Section 7.8.6), grass channel (Section 7.8.7) or rain garden (Section 7.8.9).
- All overflow pipes should be directed away from adjacent buildings to prevent damage to building foundations.
- Distribution systems may be gravity fed or may include a pump to provide the energy necessary to convey harvested rainwater from the storage tank to its final destination. Rainwater harvesting systems used to provide water for non-potable outdoor uses typically use gravity to feed watering hoses through a tap and spigot arrangement.

Construction Considerations

To help ensure that rainwater harvesting systems are successfully installed on a development site, site planning and design teams should consider the following recommendations:

- Rainwater harvesting systems may be installed on development and redevelopment sites after building rooftops and rooftop drainage systems (e.g., gutter and downspout systems) have been constructed.

Maintenance Requirements

Maintenance is important for rainwater harvesting systems, particularly in terms of ensuring that they continue to provide measurable stormwater management benefits over time. Consequently, a legally-binding inspection and maintenance agreement and plan should be put in place to ensure that rainwater harvesting systems are regularly maintained after occupancy. Table 7.36 provides a list of the routine maintenance activities typically associated with rainwater harvesting systems.

Activity	Schedule
<ul style="list-style-type: none"> Inspect storage tank screens and pretreatment devices. Clean as needed. 	Regularly (Monthly)
<ul style="list-style-type: none"> Inspect gutters and downspouts. Remove any accumulated leaves or debris. Clean storage tank screens. Inspect pretreatment devices for sediment accumulation. Remove accumulated trash and debris. Inspect storage tank for algal blooms. Treat as necessary. Inspect overflow areas for erosion and the formation of rills and gullies. Plant replacement vegetation in any eroded areas. 	Annually (Semi-Annually During First Year)

Additional Resources

Texas Water Development Board (TWDB). 2005. *The Texas Manual on Rainwater Harvesting*. 3rd Edition. Texas Water Development Board. Austin, TX. Available Online: http://www.twdb.state.tx.us/publications/reports/RainwaterHarvestingManual_3rdedition.pdf.

Rupp, G. 1998. *Rainwater Harvesting Systems for Montana*. Montana State University Extension Service. Bozeman, MT. Available Online: <http://www.montana.edu/wwwpb/pubs/mt9707.html>.

City of Portland, OR. 2008. "Rainwater Harvesting." *Portland Stormwater Management Manual*. Section 2.3.3. City of Portland, OR. Bureau of Environmental Services. Available Online: <http://www.portlandonline.com/bes/index.cfm?c=47952>.

Jones, M.P. and W.F. Hunt. 2008. *Rainwater Harvesting: Guidance for Homeowners*. North Carolina Cooperative Extension Service Bulletin. Urban Waterways Series. AGW-588-11. North Carolina State University. Raleigh, NC. Available Online: <http://www.bae.ncsu.edu/stormwater/PublicationFiles/WaterHarvestHome2008.pdf>.

7.8.13 Bioretention Areas

Description

Bioretention areas, which may also be classified as a stormwater management practice (Section 8.6.3), are shallow depressional areas that are filled with an engineered soil mix and are planted with trees, shrubs and other herbaceous vegetation. They are designed to capture and temporarily store stormwater runoff in the engineered soil mix, where it is subjected to the hydrologic processes of evaporation and transpiration, before being conveyed back into the storm drain system through an underdrain or allowed to infiltrate into the surrounding soils. This allows them to provide measurable reductions in post-construction stormwater runoff rates, volumes and pollutant loads on development sites.



(Source: Center for Watershed Protection)

<p style="text-align: center;"><u>KEY CONSIDERATIONS</u></p> <p>DESIGN CRITERIA:</p> <ul style="list-style-type: none"> • Bioretention areas should be designed to completely drain within 48 hours of the end of a rainfall event • A maximum ponding depth of 9 inches is recommended within bioretention areas to help prevent the formation of nuisance ponding conditions • Unless a shallow water table is found on the development site, bioretention area planting beds should be at least 3 feet deep <p>BENEFITS:</p> <ul style="list-style-type: none"> • Helps restore pre-development hydrology on development sites and reduces post-construction stormwater runoff rates, volumes and pollutant loads • Can be integrated into development plans as attractive landscaping features <p>LIMITATIONS:</p> <ul style="list-style-type: none"> • Can only be used to “receive” runoff from relatively small drainage areas of 5 acres in size 	<p style="text-align: center;"><u>STORMWATER MANAGEMENT “CREDITS”</u></p> <ul style="list-style-type: none"> <input checked="" type="checkbox"/> Runoff Reduction <input checked="" type="checkbox"/> Water Quality Protection <input checked="" type="checkbox"/> Aquatic Resource Protection <input checked="" type="checkbox"/> Overbank Flood Protection <input checked="" type="checkbox"/> Extreme Flood Protection <p><input checked="" type="checkbox"/> = practice has been assigned quantifiable stormwater management “credits” that can be used to address this SWM Criteria</p>						
<p style="text-align: center;"><u>SITE APPLICABILITY</u></p> <table border="0"> <tr> <td><input checked="" type="checkbox"/> Rural Use</td> <td><input type="checkbox"/> Construction Cost</td> </tr> <tr> <td><input checked="" type="checkbox"/> Suburban Use</td> <td><input type="checkbox"/> Maintenance</td> </tr> <tr> <td><input checked="" type="checkbox"/> Urban Use</td> <td><input type="checkbox"/> Area Required</td> </tr> </table>	<input checked="" type="checkbox"/> Rural Use	<input type="checkbox"/> Construction Cost	<input checked="" type="checkbox"/> Suburban Use	<input type="checkbox"/> Maintenance	<input checked="" type="checkbox"/> Urban Use	<input type="checkbox"/> Area Required	<p style="text-align: center;"><u>STORMWATER MANAGEMENT PRACTICE PERFORMANCE</u></p> <p>Runoff Reduction 40%/80% - Annual Runoff Volume Varies¹ - Runoff Reduction Volume</p> <p>Pollutant Removal² 80% - Total Suspended Solids 60% - Total Phosphorus 60% - Total Nitrogen N/A - Metals 80% - Pathogens</p> <p>1 = varies according to storage capacity of the bioretention area 2 = expected annual pollutant load removal</p>
<input checked="" type="checkbox"/> Rural Use	<input type="checkbox"/> Construction Cost						
<input checked="" type="checkbox"/> Suburban Use	<input type="checkbox"/> Maintenance						
<input checked="" type="checkbox"/> Urban Use	<input type="checkbox"/> Area Required						

Discussion

Bioretention areas (also known as *bioretention filters* and *biofilters*), which may also be classified as a stormwater management practice (Section 8.6.3), are shallow depressional areas that are filled with an engineered soil mix and are planted with trees, shrubs and other herbaceous vegetation. They are designed to capture and temporarily store stormwater runoff in the engineered soil mix, where it is subjected to the hydrologic processes of evaporation and transpiration, before being conveyed back into the storm drain system through an underdrain or allowed to infiltrate into the surrounding soils. This allows them to provide measurable reductions in post-construction stormwater runoff rates, volumes and pollutant loads on development sites.

Bioretention areas (Figure 7.43) are one of the most effective low impact development practices that can be used in coastal Georgia to reduce post-construction stormwater runoff rates, volumes and pollutant loads. They also provide a number of other benefits, including improved aesthetics, wildlife habitat, urban heat island mitigation and improved air quality. Bioretention areas differ from rain gardens (Section 7.8.9), in that they are designed to receive stormwater runoff from larger drainage areas and may be equipped with an underdrain.



Figure 7.43: Various Bioretention Areas

Stormwater Management “Credits”

The Center for Watershed Protection (Hirschman et al., 2008) recently documented the ability of bioretention areas to reduce annual stormwater runoff volumes and pollutant loads on development sites. Consequently, this low impact development practice has been assigned

quantifiable stormwater management “credits” that can be used to help satisfy the SWM Criteria presented in this CSS:

- **Stormwater Runoff Reduction:** Subtract 100% of the storage volume provided by a non-underdrained *bioretention area* from the runoff reduction volume (RR_v) conveyed through the *bioretention area*. Subtract 50% of the storage volume provided by an underdrained *bioretention area* from the runoff reduction volume (RR_v) conveyed through the *bioretention area*.
- **Water Quality Protection:** Subtract 100% of the storage volume provided by a non-underdrained *bioretention area* from the runoff reduction volume (RR_v) conveyed through the *bioretention area*. Subtract 50% of the storage volume provided by an underdrained *bioretention area* from the runoff reduction volume (RR_v) conveyed through the *bioretention area*.
- **Aquatic Resource Protection:** Proportionally adjust the post-development runoff curve number (CN) to account for the runoff reduction provided by a *bioretention area* when calculating the aquatic resource protection volume (ARP_v) on a development site.
- **Overbank Flood Protection:** Proportionally adjust the post-development runoff curve number (CN) to account for the runoff reduction provided by a *bioretention area* when calculating the overbank peak discharge (Q_{p25}) on a development site.
- **Extreme Flood Protection:** Proportionally adjust the post-development runoff curve number (CN) to account for the runoff reduction provided by a *bioretention area* when calculating the extreme peak discharge (Q_{p100}) on a development site.

The storage volume provided by a bioretention area can be determined using the following equation:

$$\text{Storage Volume} = \text{Surface Area} \times [\text{Ponding Depth} + (\text{Depth of Planting Bed} \times \text{Void Ratio})]$$

A void ratio (i.e., void space/total volume) of 0.32 should be used in all storage volume calculations, unless more specific planting bed void ratio data are available.

In order to “receive” stormwater runoff and be eligible for these “credits,” it is *recommended* that bioretention areas satisfy the planning and design criteria outlined below.

Overall Feasibility

The criteria listed in Table 7.37 should be evaluated to determine whether or not a bioretention area is appropriate for use on a development site.

Table 7.37: Factors to Consider When Evaluating the Overall Feasibility of Using a Bioretention Area on a Development Site	
Site Characteristic	Criteria
Drainage Area	Although bioretention areas can be used to “receive” stormwater runoff from contributing drainage areas as large as 5 acres in size, contributing drainage areas of between 2,500 square feet and 2 acres are preferred.

Table 7.37: Factors to Consider When Evaluating the Overall Feasibility of Using a Bioretention Area on a Development Site

Site Characteristic	Criteria
Area Required	Bioretention area surface area requirements vary according to the size of the contributing drainage area and the infiltration rate of the soils on which the bioretention area will be located. In general, bioretention areas require about 5-10% of the size of their contributing drainage areas.
Slope	Although bioretention areas may be used on development sites with slopes of up to 6%, they should be designed with slopes that are as close to flat as possible to help ensure that stormwater runoff is evenly distributed over the planting bed.
Minimum Head	Bioretention areas may be designed with a maximum ponding depth of 12 inches, although a ponding depth of 9 inches is recommended to help prevent the formation of nuisance ponding conditions. Unless a shallow water table is found on the development site, all bioretention area planting beds should be at least 36 inches deep.
Minimum Depth to Water Table	2 feet
Soils	Bioretention areas should be designed to completely drain within 48 hours of the end of a rainfall event. Consequently, non-underdrained bioretention areas generally should not be used on development sites that have soils with infiltration rates of less than 0.25 inches per hour (i.e., hydrologic soil group C and D soils). Underdrained bioretention areas may be used to "receive" stormwater runoff on development sites that have soils with infiltration rates of less than 0.25 inches per hour.

Feasibility in Coastal Georgia

Several site characteristics commonly encountered in coastal Georgia may present challenges to site planning and design teams that are interested in using bioretention areas to "receive" post-construction stormwater runoff on a development site. Table 7.38 identifies these common site characteristics and describes how they influence the use of bioretention areas on development sites. The table also provides site planning and design teams with some ideas about how they can work around these potential constraints.

Table 7.38: Challenges Associated with Using Bioretention Areas in Coastal Georgia

Site Characteristic	How it Influences the Use of Bioretention Areas	Potential Solutions
<ul style="list-style-type: none"> <i>Poorly drained soils, such as hydrologic soil group C and D soils</i> 	<ul style="list-style-type: none"> Reduces the ability of bioretention areas to reduce stormwater runoff rates, volumes and pollutant loads. 	<ul style="list-style-type: none"> Use underdrained bioretention areas to "receive" stormwater runoff in these areas. Use rainwater harvesting (Section 7.8.12), small stormwater wetlands (i.e., pocket wetlands) (Section 8.6.2) or wet swales (Section 8.6.6), instead of bioretention areas to intercept and treat stormwater runoff in these areas.

Table 7.38: Challenges Associated with Using Bioretention Areas in Coastal Georgia

Site Characteristic	How it Influences the Use of Bioretention Areas	Potential Solutions
<ul style="list-style-type: none"> • <i>Well drained soils, such as hydrologic soil group A and B soils</i> 	<ul style="list-style-type: none"> • Enhances the ability of bioretention areas to reduce stormwater runoff rates, volumes and pollutant loads, but may allow stormwater pollutants to reach groundwater aquifers with greater ease. 	<ul style="list-style-type: none"> • Avoid the use of infiltration-based low impact development practices, including non-underdrained bioretention areas, at stormwater hotspots and in areas known to provide groundwater recharge to water supply aquifers, unless adequate pretreatment is provided upstream of them. • Use bioretention areas and dry swales (Section 7.8.15) with liners and underdrains at stormwater hotspots and in areas known to provide groundwater recharge to water supply aquifers.
<ul style="list-style-type: none"> • <i>Flat terrain</i> 	<ul style="list-style-type: none"> • May be difficult to provide adequate drainage and may cause stormwater runoff to pond in the bioretention area for extended periods of time. 	<ul style="list-style-type: none"> • Ensure that the underlying native soils will allow the bioretention area to drain completely within 48 hours of the end of a rainfall event to prevent the formation of nuisance ponding conditions.
<ul style="list-style-type: none"> • <i>Shallow water table</i> 	<ul style="list-style-type: none"> • May be difficult to provide 2 feet of clearance between the bottom of the bioretention area and the top of the water table. • May occasionally cause stormwater runoff to pond in the bioretention area. 	<ul style="list-style-type: none"> • Ensure that the distance from the bottom of the bioretention area to the top of the water table is at least 2 feet. • Reduce the depth of the planting bed to 18 inches. • Use stormwater ponds (Section 8.6.1), stormwater wetlands (Section 8.6.2) and wet swales (Section 8.6.6), instead of bioretention areas to intercept and treat stormwater runoff in these areas.
<ul style="list-style-type: none"> • <i>Tidally-influenced drainage system</i> 	<ul style="list-style-type: none"> • May occasionally prevent stormwater runoff from being conveyed through a bioretention area, particularly during high tide. 	<ul style="list-style-type: none"> • Investigate the use of other low impact development practices, such as rainwater harvesting (Section 7.8.12) to “receive” stormwater runoff in these areas.

Site Applicability

Bioretention areas can be used to “receive” stormwater runoff on a wide variety of development sites, including residential, commercial and institutional development sites in rural, suburban and urban areas. They are well suited to “receive” stormwater runoff from nearly all small impervious and pervious drainage areas, including local streets and roadways, highways, driveways, small parking areas and disturbed pervious areas (e.g., lawns, parks, community

open spaces). When compared with other low impact development practices, bioretention areas have a moderate construction cost, a moderate maintenance burden and require a relatively small amount of surface area.

Planning and Design Criteria

Additional information regarding the planning and design of bioretention areas is provided in Section 8.6.3.

7.8.14 Infiltration Practices

Description

Infiltration practices, which may also be classified as a stormwater management practice (Section 8.6.5), are shallow excavations, typically filled with stone or an engineered soil mix, that are designed to intercept and temporarily store post-construction stormwater runoff until it infiltrates into the underlying and surrounding soils. If properly designed, they can provide significant reductions in post-construction stormwater runoff rates, volumes and pollutant loads on development sites. Consequently, infiltration practices can be used to help satisfy the SWM Criteria presented in this CSS.



(Source: Center for Watershed Protection)

<p><u>KEY CONSIDERATIONS</u></p> <p>DESIGN CRITERIA:</p> <ul style="list-style-type: none"> • Pretreatment should be provided upstream of all infiltration practices • Infiltration practices should be designed to completely drain within 48 hours of the end of a rainfall event • Underlying native soils should have an infiltration rate of 0.5 in/hr or more • The distance from the bottom of an infiltration practice to the top of the water table should be 2 feet or more <p>BENEFITS:</p> <ul style="list-style-type: none"> • Helps restore pre-development hydrology on development sites and reduces post-construction stormwater runoff rates, volumes and pollutant loads • Can be integrated into development plans as attractive landscaping features <p>LIMITATIONS:</p> <ul style="list-style-type: none"> • Can only be used to “receive” runoff from relatively small drainage areas of 2-5 acres in size • Should not be used to “receive” stormwater runoff that contains high sediment loads 	<p><u>STORMWATER MANAGEMENT “CREDITS”</u></p> <ul style="list-style-type: none"> <input checked="" type="checkbox"/> Runoff Reduction <input checked="" type="checkbox"/> Water Quality Protection <input checked="" type="checkbox"/> Aquatic Resource Protection <input checked="" type="checkbox"/> Overbank Flood Protection <input checked="" type="checkbox"/> Extreme Flood Protection <p><input checked="" type="checkbox"/> = practice has been assigned quantifiable stormwater management “credits” that can be used to address this SWM Criteria</p>		
<p><u>SITE APPLICABILITY</u></p> <table style="width: 100%; border: none;"> <tr> <td style="width: 50%; vertical-align: top;"> <ul style="list-style-type: none"> <input checked="" type="checkbox"/> Rural Use <input checked="" type="checkbox"/> Suburban Use <input checked="" type="checkbox"/> Urban Use </td> <td style="width: 50%; vertical-align: top;"> <ul style="list-style-type: none"> <input type="checkbox"/> Construction Cost <input type="checkbox"/> Maintenance <input type="checkbox"/> Area Required </td> </tr> </table>	<ul style="list-style-type: none"> <input checked="" type="checkbox"/> Rural Use <input checked="" type="checkbox"/> Suburban Use <input checked="" type="checkbox"/> Urban Use 	<ul style="list-style-type: none"> <input type="checkbox"/> Construction Cost <input type="checkbox"/> Maintenance <input type="checkbox"/> Area Required 	<p><u>STORMWATER MANAGEMENT PRACTICE PERFORMANCE</u></p> <p>Runoff Reduction 80% - Annual Runoff Volume Varies¹ - Runoff Reduction Volume</p> <p>Pollutant Removal² 80% - Total Suspended Solids 60% - Total Phosphorus 60% - Total Nitrogen N/A - Metals 80% - Pathogens</p> <p><small>1 = varies according to storage capacity of the infiltration practice 2 = expected annual pollutant load removal</small></p>
<ul style="list-style-type: none"> <input checked="" type="checkbox"/> Rural Use <input checked="" type="checkbox"/> Suburban Use <input checked="" type="checkbox"/> Urban Use 	<ul style="list-style-type: none"> <input type="checkbox"/> Construction Cost <input type="checkbox"/> Maintenance <input type="checkbox"/> Area Required 		

Discussion

Infiltration practices (Figure 7.44), which may also be classified as a stormwater management practice (Section 8.6.5), are shallow excavations, typically filled with stone or an engineered soil mix, that are designed to intercept and temporarily store post-construction stormwater runoff until it infiltrates into the underlying and surrounding soils. If properly designed, they can provide significant reductions in post-construction stormwater runoff rates, volumes and pollutant loads on development sites.

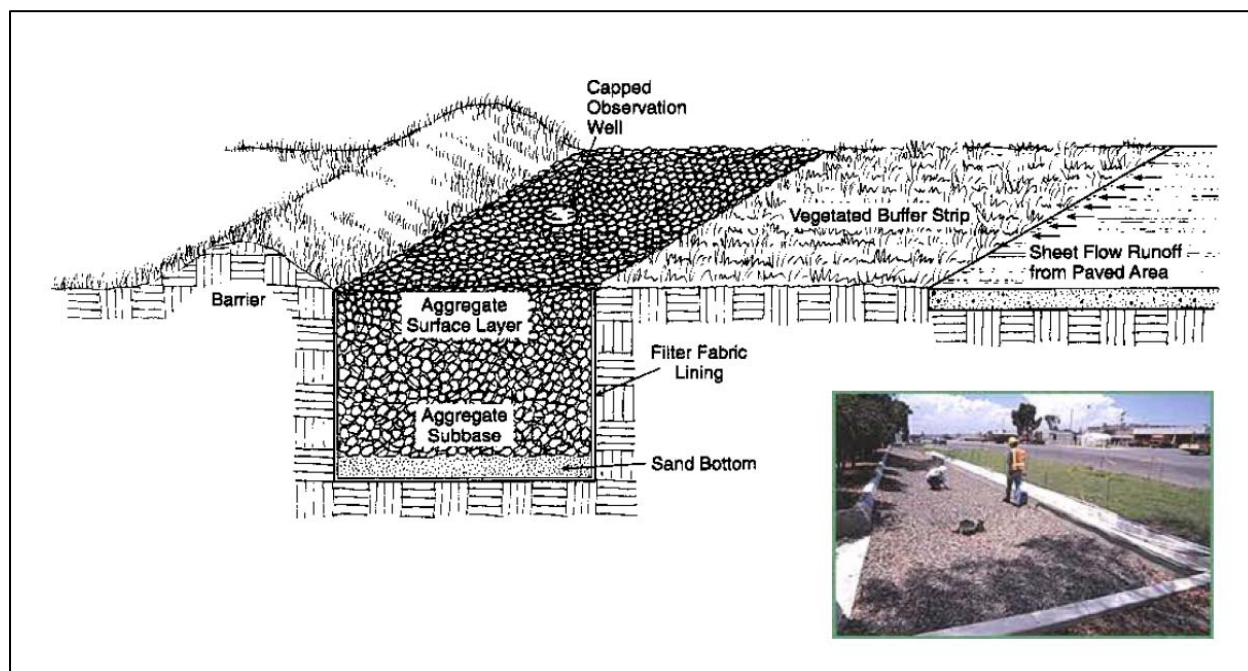

Figure 7.44: Infiltration Trench
(Source: Center for Watershed Protection)

Although infiltration practices can provide significant reductions in post-construction stormwater runoff rates, volumes and pollutant loads, they have historically experienced high rates of failure due to clogging caused by poor design, poor construction and neglected maintenance. If infiltration practices are to be used on a development site, great care should be taken to ensure that they are adequately designed, carefully installed and properly maintained over time. They should only be applied on development sites that have permeable soils (i.e., hydrologic soil group A and B soils) and that have a water table and confining layers (e.g., bedrock, clay lenses) that are located at least 2 feet below the bottom of the trench or basin. Additionally, infiltration practices should always be designed with adequate pretreatment (e.g., vegetated filter strip, sediment forebay) to prevent sediment from reaching them and causing them to clog and fail.

There are two major variations of infiltration practices, namely infiltration trenches and infiltration basins (Figure 7.45). A brief description of each of these design variants is provided below:

- **Infiltration Trenches:** Infiltration trenches are excavated trenches filled with stone. Stormwater runoff is captured and temporarily stored in the stone reservoir, where it is allowed to infiltrate into the surrounding and underlying native soils. Infiltration trenches can be used to “receive” stormwater runoff from contributing drainage areas of up to 2 acres in size and should only be used on development sites where sediment loads can be kept relatively low.

- **Infiltration Basins:** Infiltration basins are shallow, landscaped excavations filled with an engineered soil mix. They are designed to capture and temporarily store stormwater runoff in the engineered soil mix, where it is subjected to the hydrologic processes of evaporation and transpiration, before being allowed to infiltrate into the surrounding soils. They are essentially non-underdrained bioretention areas (Section 7.8.13), and should also only be used on development sites where sediment loads can be kept relatively low.



Figure 7.45: Infiltration Practices

Stormwater Management “Credits”

The Center for Watershed Protection (Hirschman et al., 2008) recently documented the ability of infiltration practices to reduce annual stormwater runoff volumes and pollutant loads on development sites. Consequently, this low impact development practice has been assigned quantifiable stormwater management “credits” that can be used to help satisfy the SWM Criteria presented in this CSS:

- **Stormwater Runoff Reduction:** Subtract 100% of the storage volume provided by an *infiltration practice* from the runoff reduction volume (RR_v) conveyed through the *infiltration practice*.
- **Water Quality Protection:** Subtract 100% of the storage volume provided by an *infiltration practice* from the runoff reduction volume (RR_v) conveyed through the *infiltration practice*.
- **Aquatic Resource Protection:** Proportionally adjust the post-development runoff curve number (CN) to account for the runoff reduction provided by an *infiltration practice* when calculating the aquatic resource protection volume (ARP_v) on a development site.
- **Overbank Flood Protection:** Proportionally adjust the post-development runoff curve number (CN) to account for the runoff reduction provided by an *infiltration practice* when calculating the overbank peak discharge (Q_{p25}) on a development site.

- **Extreme Flood Protection:** Proportionally adjust the post-development runoff curve number (CN) to account for the runoff reduction provided by an *infiltration practice* when calculating the extreme peak discharge (Q_{p100}) on a development site.

The storage volume provided by an infiltration trench can be determined using the following equation:

$$\text{Storage Volume} = \text{Surface Area} \times \text{Depth} \times \text{Void Ratio}$$

A void ratio (i.e., void space/total volume) of 0.32 should be used in all storage volume calculations, unless more specific aggregate void ratio data are available.

The storage volume provided by a infiltration basin can be determined using the following equation:

$$\text{Storage Volume} = \text{Surface Area} \times [\text{Ponding Depth} + (\text{Depth of Planting Bed} \times \text{Void Ratio})]$$

A void ratio (i.e., void space/total volume) of 0.32 should be used in all storage volume calculations, unless more specific planting bed void ratio data are available.

In order to “receive” stormwater runoff and be eligible for these “credits,” it is *recommended* that infiltration practices satisfy the planning and design criteria outlined below.

Overall Feasibility

The criteria listed in Table 7.39 should be evaluated to determine whether or not an infiltration practice is appropriate for use on a development site.

Table 7.39: Factors to Consider When Evaluating the Overall Feasibility of Using an Infiltration Practice on a Development Site	
Site Characteristic	Criteria
Drainage Area	Infiltration trenches should only be used to “receive” stormwater runoff from contributing drainage areas less than 2 acres in size. Although infiltration basins can be used to “receive” stormwater runoff from contributing drainage areas as large as 5 acres in size, contributing drainage areas of between 2,500 square feet and 2 acres are preferred.
Area Required	Infiltration practice surface area requirements vary according to the size of the contributing drainage area and the infiltration rate of the soils on which the infiltration practice will be located. In general, infiltration practices require about 5% of the size of their contributing drainage areas.
Slope	Although infiltration practices may be used on development sites with slopes of up to 6%, they should be designed with slopes that are as close to flat as possible to help ensure that stormwater runoff is evenly distributed over the infiltration bed.
Minimum Head	Unless a shallow water table is found on the development site, all infiltration trenches should be designed to be at least 36 inches deep. Infiltration basins may be designed with a maximum ponding depth of 12 inches, although a ponding depth of 9 inches is recommended to help prevent the formation of nuisance ponding conditions. Unless a shallow water table is found on the development site, all infiltration basin planting beds should be at least 36 inches deep.

Table 7.39: Factors to Consider When Evaluating the Overall Feasibility of Using an Infiltration Practice on a Development Site

Site Characteristic	Criteria
Minimum Depth to Water Table	2 feet
Soils	Infiltration practices should be designed to completely drain within 48 hours of the end of a rainfall event. Consequently, infiltration practices generally should not be used on development sites that have soils with infiltration rates of less than 0.25 inches per hour (i.e., hydrologic soil group C and D soils).

Feasibility in Coastal Georgia

Several site characteristics commonly encountered in coastal Georgia may present challenges to site planning and design teams that are interested in using infiltration practices to “receive” post-construction stormwater runoff on a development site. Table 7.40 identifies these common site characteristics and describes how they influence the use of infiltration practices on development sites. The table also provides site planning and design teams with some ideas about how they can work around these potential constraints.

Table 7.40: Challenges Associated with Using Infiltration Practices in Coastal Georgia

Site Characteristic	How it Influences the Use of Infiltration Practices	Potential Solutions
<ul style="list-style-type: none"> <i>Poorly drained soils, such as hydrologic soil group C and D soils</i> 	<ul style="list-style-type: none"> Reduces the ability of infiltration practices to reduce stormwater runoff rates, volumes and pollutant loads. 	<ul style="list-style-type: none"> Infiltration practices should not be used on development sites that have soils with infiltration rates of less than 0.25 inches per hour (i.e., hydrologic soil group C and D soils). Use other low impact development practices, such as rainwater harvesting (Section 7.8.12) and underdrained bioretention areas (Section 7.8.13), to “receive” stormwater runoff in these areas.
<ul style="list-style-type: none"> <i>Well drained soils, such as hydrologic soil group A and B soils</i> 	<ul style="list-style-type: none"> Enhances the ability of infiltration practices to reduce stormwater runoff rates, volumes and pollutant loads, but may allow stormwater pollutants to reach groundwater aquifers with greater ease. 	<ul style="list-style-type: none"> Avoid the use of infiltration-based low impact development practices, including infiltration practices, at stormwater hotspots and in areas known to provide groundwater recharge to water supply aquifers, unless adequate pretreatment is provided upstream of them. Use bioretention areas (Section 7.8.13) and dry swales (Section 7.8.15) with liners and underdrains at stormwater hotspots and in areas known to provide groundwater recharge to water supply aquifers.

Table 7.40: Challenges Associated with Using Infiltration Practices in Coastal Georgia		
Site Characteristic	How it Influences the Use of Infiltration Practices	Potential Solutions
<ul style="list-style-type: none"> • <i>Flat terrain</i> 	<ul style="list-style-type: none"> • Does not influence the use of infiltration practices. In fact, infiltration practices should be designed with slopes that are as close to flat as possible. 	
<ul style="list-style-type: none"> • <i>Shallow water table</i> 	<ul style="list-style-type: none"> • May be difficult to provide 2 feet of clearance between the bottom of the infiltration practice and the top of the water table. • May occasionally cause stormwater runoff to pond in the bottom of the infiltration practice. 	<ul style="list-style-type: none"> • Ensure that the distance from the bottom of the infiltration practice to the top of the water table is at least 2 feet. • Reduce the depth of the stone reservoir in infiltration trenches to 18 inches. • Reduce the depth of the planting bed in infiltration basins to 18 inches. • Use stormwater ponds (Section 8.6.1), stormwater wetlands (Section 8.6.2) and wet swales (Section 8.6.6), instead of infiltration practices to intercept and treat stormwater runoff in these areas.
<ul style="list-style-type: none"> • <i>Tidally-influenced drainage system</i> 	<ul style="list-style-type: none"> • Does not influence the use of infiltration practices. 	

Site Applicability

Infiltration practices can be used to “receive” stormwater runoff on development sites in rural, suburban and urban areas where the soils are permeable enough and the water table is low enough to provide for the infiltration of stormwater runoff. While infiltration trenches are particularly well-suited for use on small, medium-to-high density development sites, infiltration basins can be used on larger, lower density development sites. Infiltration practices should only be considered for use on development sites where fine sediment (e.g., clay, silt) loads will be relatively low, as high sediment loads will cause them to clog and fail. In addition, infiltration practices should be carefully sited to avoid the potential contamination of water supply aquifers. When compared with other low impact development practices, infiltration practices have a moderate construction cost, a moderate maintenance burden and require a relatively small amount of surface area.

Planning and Design Criteria

Additional information regarding the planning and design of infiltration practices is provided in Section 8.6.5.

7.8.15 Dry Swales

Description

Dry swales, which may also be classified as a stormwater management practice (Section 8.6.6), are vegetated open channels that are filled with an engineered soil mix and are planted with trees, shrubs and other herbaceous vegetation. They are essentially linear bioretention areas (Section 7.8.13), in that they are designed to capture and temporarily store stormwater runoff in the engineered soil mix, where it is subjected to the hydrologic processes of evaporation and transpiration, before being conveyed back into the storm drain system through an underdrain or allowed to infiltrate into the surrounding soils.



(Source: Atlanta Regional Commission, 2001)

<p style="text-align: center;"><u>KEY CONSIDERATIONS</u></p> <p>DESIGN CRITERIA:</p> <ul style="list-style-type: none"> • Dry swales should be designed to accommodate the peak discharge generated by the target runoff reduction rainfall event (e.g., 85th percentile rainfall event) • Dry swales should be designed to able to safely convey the overbank flood protection rainfall event (e.g., 25-year, 24-hour event) • Dry swales may be designed with a slope of between 0.5% and 4%, although a slope of between 1% and 2% is recommended • Dry swales should be designed to completely drain within 48 hours of the end of a rainfall event <p>BENEFITS:</p> <ul style="list-style-type: none"> • Helps restore pre-development hydrology on development sites and reduces post-construction stormwater runoff rates, volumes and pollutant loads • Less expensive than traditional drainage (e.g., curb and gutter, storm drain) systems <p>LIMITATIONS:</p> <ul style="list-style-type: none"> • Can only be used to “receive” runoff from relatively small drainage areas of 5 acres in size 	<p style="text-align: center;"><u>STORMWATER MANAGEMENT “CREDITS”</u></p> <ul style="list-style-type: none"> <input checked="" type="checkbox"/> Runoff Reduction <input checked="" type="checkbox"/> Water Quality Protection <input checked="" type="checkbox"/> Aquatic Resource Protection <input checked="" type="checkbox"/> Overbank Flood Protection <input checked="" type="checkbox"/> Extreme Flood Protection <p><input checked="" type="checkbox"/> = practice has been assigned quantifiable stormwater management “credits” that can be used to address this SWM Criteria</p>						
<p style="text-align: center;"><u>SITE APPLICABILITY</u></p> <table border="0"> <tr> <td><input checked="" type="checkbox"/> Rural Use</td> <td><input type="checkbox"/> Construction Cost</td> </tr> <tr> <td><input checked="" type="checkbox"/> Suburban Use</td> <td><input type="checkbox"/> Maintenance</td> </tr> <tr> <td><input checked="" type="checkbox"/> * Urban Use</td> <td><input type="checkbox"/> Area Required</td> </tr> </table>	<input checked="" type="checkbox"/> Rural Use	<input type="checkbox"/> Construction Cost	<input checked="" type="checkbox"/> Suburban Use	<input type="checkbox"/> Maintenance	<input checked="" type="checkbox"/> * Urban Use	<input type="checkbox"/> Area Required	<p style="text-align: center;"><u>STORMWATER MANAGEMENT PRACTICE PERFORMANCE</u></p> <p>Runoff Reduction 40%/80% - Annual Runoff Volume Varies¹ - Runoff Reduction Volume</p> <p>Pollutant Removal² 80% - Total Suspended Solids 50% - Total Phosphorus 50% - Total Nitrogen N/A - Metals 60% - Pathogens</p> <p>1 = varies according to storage capacity of the dry swale 2 = expected annual pollutant load removal</p>
<input checked="" type="checkbox"/> Rural Use	<input type="checkbox"/> Construction Cost						
<input checked="" type="checkbox"/> Suburban Use	<input type="checkbox"/> Maintenance						
<input checked="" type="checkbox"/> * Urban Use	<input type="checkbox"/> Area Required						

Discussion

Dry swales (also known as *bioswales*), which may also be classified as a stormwater management practice (Section 8.6.6), are vegetated open channels that are filled with an engineered soil mix and are planted with trees, shrubs and other herbaceous vegetation. They are essentially linear bioretention areas (Section 7.8.13), in that they are designed to capture and temporarily store stormwater runoff in the engineered soil mix, where it is subjected to the hydrologic processes of evaporation and transpiration, before being conveyed back into the storm drain system through an underdrain or allowed to infiltrate into the surrounding soils. This allows them to provide measurable reductions in post-construction stormwater runoff rates, volumes and pollutant loads on development sites. Consequently, they can be used to help satisfy the SWM Criteria presented in this CSS.

Stormwater Management “Credits”

The Center for Watershed Protection (Hirschman et al., 2008) recently documented the ability of dry swales to reduce annual stormwater runoff volumes and pollutant loads on development sites. Consequently, this low impact development practice has been assigned quantifiable stormwater management “credits” that can be used to help satisfy the SWM Criteria presented in this CSS:

- **Stormwater Runoff Reduction:** Subtract 100% of the storage volume provided by a non-underdrained *dry swale* from the runoff reduction volume (RR_v) conveyed through the *dry swale*. Subtract 50% of the storage volume provided by an underdrained *dry swale* from the runoff reduction volume (RR_v) conveyed through the *dry swale*.
- **Water Quality Protection:** Subtract 100% of the storage volume provided by a non-underdrained *dry swale* from the runoff reduction volume (RR_v) conveyed through the *dry swale*. Subtract 50% of the storage volume provided by an underdrained *dry swale* from the runoff reduction volume (RR_v) conveyed through the *dry swale*.
- **Aquatic Resource Protection:** Proportionally adjust the post-development runoff curve number (CN) to account for the runoff reduction provided by a *dry swale* when calculating the aquatic resource protection volume (ARP_v) on a development site.
- **Overbank Flood Protection:** Proportionally adjust the post-development runoff curve number (CN) to account for the runoff reduction provided by a *dry swale* when calculating the overbank peak discharge (Q_{p25}) on a development site.
- **Extreme Flood Protection:** Proportionally adjust the post-development runoff curve number (CN) to account for the runoff reduction provided by a *dry swale* when calculating the extreme peak discharge (Q_{p100}) on a development site.

The storage volume provided by a dry swale can be determined using the following equation:

$$\text{Storage Volume} = \text{Surface Area} \times [\text{Ponding Depth} + (\text{Depth of Planting Bed} \times \text{Void Ratio})]$$

A void ratio (i.e., void space/total volume) of 0.32 should be used in all storage volume calculations, unless more specific planting bed void ratio data are available.

In order to “receive” stormwater runoff and be eligible for these “credits,” it is *recommended* that dry swales satisfy the planning and design criteria outlined below.

Overall Feasibility

The criteria listed in Table 7.41 should be evaluated to determine whether or not a dry swale is appropriate for use on a development site.

Table 7.41: Factors to Consider When Evaluating the Overall Feasibility of Using a Dry Swale on a Development Site	
Site Characteristic	Criteria
Drainage Area	Dry swales can be used to “receive” stormwater runoff from contributing drainage areas as large as 5 acres in size.
Area Required	Dry swale surface area requirements vary according to the size of the contributing drainage area and the infiltration rate of the soils on which the dry swale will be located. In general, dry swales require about 5-10% of the size of their contributing drainage areas.
Slope	Although dry swales may be installed on development sites with slopes of between 0.5% and 4%, it is recommended that they be designed with slopes of between 1% and 2% to help ensure adequate drainage.
Minimum Head	Unless a shallow water table is found on the development site, all dry swale planting beds should be at least 30 inches deep.
Minimum Depth to Water Table	2 feet
Soils	Dry swales should be designed to completely drain within 48 hours of the end of a rainfall event. Consequently, non-underdrained dry swales generally should not be used on development sites that have soils with infiltration rates of less than 0.25 inches per hour (i.e., hydrologic soil group C and D soils). Underdrained dry swales may be used to “receive” stormwater runoff on development sites that have soils with infiltration rates of less than 0.25 inches per hour.

Feasibility in Coastal Georgia

Several site characteristics commonly encountered in coastal Georgia may present challenges to site planning and design teams that are interested in using dry swales to “receive” post-construction stormwater runoff on a development site. Table 7.42 identifies these common site characteristics and describes how they influence the use of dry swales on development sites. The table also provides site planning and design teams with some ideas about how they can work around these potential constraints.

Table 7.42: Challenges Associated with Using Dry Swales in Coastal Georgia		
Site Characteristic	How it Influences the Use of Dry Swales	Potential Solutions
<ul style="list-style-type: none"> <i>Poorly drained soils, such as hydrologic soil group C and D soils</i> 	<ul style="list-style-type: none"> Reduces the ability of dry swales to reduce stormwater runoff rates, volumes and pollutant loads. 	<ul style="list-style-type: none"> Use underdrained dry swales to “receive” stormwater runoff in these areas. Use additional low impact development practices to supplement the stormwater management benefits provided by dry swales in these areas. Use wet swales (i.e., linear wetland systems) (Section 8.6.6) to intercept, convey and treat stormwater runoff in these areas.

Table 7.42: Challenges Associated with Using Dry Swales in Coastal Georgia

Site Characteristic	How it Influences the Use of Dry Swales	Potential Solutions
<ul style="list-style-type: none"> <i>Well drained soils, such as hydrologic soil group A and B soils</i> 	<ul style="list-style-type: none"> Enhances the ability of dry swales to reduce stormwater runoff rates, volumes and pollutant loads, but may allow stormwater pollutants to reach groundwater aquifers with greater ease. 	<ul style="list-style-type: none"> Avoid the use of infiltration-based low impact development practices, including non-underdrained dry swales, at stormwater hotspots and in areas known to provide groundwater recharge to water supply aquifers, unless adequate pretreatment is provided upstream of them. Use bioretention areas (Section 7.8.13) and dry swales (with liners and underdrains at stormwater hotspots and in areas known to provide groundwater recharge to water supply aquifers).
<ul style="list-style-type: none"> <i>Flat terrain</i> 	<ul style="list-style-type: none"> May be difficult to provide adequate drainage and may cause stormwater runoff to pond in the dry swale for extended periods of time. 	<ul style="list-style-type: none"> Design dry swales with a slope of at least 0.5% to help ensure adequate drainage. Ensure that the underlying native soils or underdrain system will allow the dry swale to drain completely within 48 hours of the end of a rainfall event to prevent the formation of nuisance ponding conditions.
<ul style="list-style-type: none"> <i>Shallow water table</i> 	<ul style="list-style-type: none"> May be difficult to provide 2 feet of clearance between the bottom of the dry swale and the top of the water table. May occasionally cause stormwater runoff to pond in the dry swale. 	<ul style="list-style-type: none"> Ensure that the distance from the bottom of the dry swale to the top of the water table is at least 2 feet. Reduce the depth of the planting bed to 18 inches. Use wet swales (i.e., linear wetland systems) (Section 8.6.6) to intercept, convey and treat stormwater runoff in these areas.
<ul style="list-style-type: none"> <i>Tidally-influenced drainage system</i> 	<ul style="list-style-type: none"> May occasionally prevent stormwater runoff from being conveyed through a dry swale, particularly during high tide. 	<ul style="list-style-type: none"> Investigate the use of other low impact development practices, such as rainwater harvesting (Section 7.8.12) to “receive” stormwater runoff in these areas.

Site Applicability

Dry swales can be used to “receive” stormwater runoff on a wide variety of development sites, including residential, commercial and institutional development sites in rural, suburban and urban areas. They are well suited to “receive” stormwater runoff from nearly all small impervious

and pervious drainage areas, including local streets and roadways, highways, driveways, small parking areas and disturbed pervious areas (e.g., lawns, parks, community open spaces). When compared with other low impact development practices, dry swales have a moderate construction cost, a moderate maintenance burden and require a relatively small amount of surface area.

Planning and Design Criteria

Additional information regarding the planning and design of dry swales is provided in Section 8.6.6.

THIS PAGE INTENTIONALLY LEFT BLANK

References

- Atlanta Regional Commission (ARC). 2001. *Georgia Stormwater Management Manual*. Volume 2. Technical Handbook. Atlanta Regional Commission. Atlanta, GA. Available Online: <http://www.georgiastormwater.com/>.
- Carter, T., S. Wenger, R.M. Seymour and D. Stewart. 2007. *Runoff Limits Manual*. Final Draft. Etowah Habitat Conservation Plan.
- Cappiella, K., T. Schueler and T. Wright. 2006a. *Urban Watershed Forestry Manual. Part 2: Conserving and Planting Trees at Development Sites*. NA-TP-01-06. US Department of Agriculture. Forest Service. Northeastern Area. State and Private Forestry. Newtown Square, PA. Available Online: http://www.cwp.org/Resource_Library/Special_Resource_Management/forestry.htm.
- Cappiella, K., T. Schueler, J. Tomlinson and T. Wright. 2006b. *Urban Watershed Forestry Manual. Part 3: Urban Tree Planting Guide*. NA-TP-01-06. US Department of Agriculture. Forest Service. Northeastern Area. State and Private Forestry. Newtown Square, PA. Available Online: http://www.cwp.org/Resource_Library/Special_Resource_Management/forestry.htm.
- Center for Watershed Protection (CWP). 1998. *Better Site Design: A Handbook for Changing Development Rules in Your Community*. Center for Watershed Protection. Ellicott City, MD. Available Online: http://www.cwp.org/Resource_Library/Controlling_Runoff_and_Discharges/sm.htm.
- City of Portland, OR. 2008. *Portland Stormwater Management Manual*. City of Portland, OR. Bureau of Environmental Services. Available Online: <http://www.portlandonline.com/bes/index.cfm?c=47952>.
- City of Portland, OR. 2004. *Portland Stormwater Management Manual*. City of Portland, OR. Bureau of Environmental Services. Available Online: <http://www.portlandonline.com/bes/index.cfm?c=35122&>.
- Claytor, R. and T. Schueler. 1996. Design of Stormwater Filtering Systems. Prepared for: Chesapeake Research Consortium, Inc. Center for Watershed Protection. Ellicott City, MD. Available Online: http://www.cwp.org/Resource_Library/Center_Docs/SW/design_swfiltering.pdf.
- Faber-Taylor, A. and F.E. Kuo. 2006. "Is Contact With Nature Important for Healthy Child Development? State of the Evidence." *Children and Their Environments: Learning, Using and Designing Spaces*. C. Spencer and M. Blades (Eds.). Cambridge University Press. Cambridge, UK. Available Online: <http://www.lhhl.uiuc.edu/all.scientific.articles.htm>.
- Georgia Department of Natural Resources Wildlife Resources Division (WRD). 2005. *A Comprehensive Wildlife Conservation Strategy for Georgia*. Georgia Department of Natural Resources. Wildlife Resources Division. Social Circle, GA. Available Online: <http://www1.gadnr.org/cwcs/Documents/strategy.html>.
- Hirschman, D., K. Collins and T. Schueler. 2008. *Runoff Reduction Method*. Center for Watershed Protection. Ellicott City, MD. Available Online: http://www.cwp.org/Resource_Library/Center_Docs/SW/RRTechMemo.pdf.

- Hunt, W.F. and K.A. Collins. 2008. *Permeable Pavement: Research Update and Design Implications*. North Carolina Cooperative Extension Service Bulletin. Urban Waterways Series. AGW-588-14. North Carolina State University. Raleigh, NC. Available Online: <http://www.bae.ncsu.edu/stormwater/PublicationFiles/PermPave2008.pdf>.
- Kuo, F.E. 2003. "The Role of Arboriculture in a Healthy Social Ecology: Invited Review Article for a Special Section." *Journal of Arboriculture*. 29(3): 148-155. Available Online: <http://www.lhhl.uiuc.edu/all.scientific.articles.htm>.
- Kuo, F.E. and W.C. Sullivan. 2001. "Environment and Crime in the Inner City: Does Vegetation Reduce Crime?" *Environment and Behavior*. 33(3): 343-367. Available Online: <http://www.lhhl.uiuc.edu/all.scientific.articles.htm>.
- Lantin, A. and Barrett, M. 2005. "Design and Pollutant Reduction of Vegetated Strips and Swales." *Proceedings of the World Water and Environmental Resources Congress, May 15-19, 2005*. American Society of Civil Engineers. Environmental and Water Resources Institute.
- Law, N.L., K. Cappiella and M.E. Novotney. 2009. "The Need to Address Both Impervious and Pervious Surfaces in Urban Watershed and Stormwater Management." *Journal of Hydrologic Engineering*. 14(4): 305-308.
- MacMullan, E. and S. Reich. 2007. *The Economics of Low Impact Development: A Literature Review*. ECONorthwest. Eugene, OR. Available Online: http://www.econw.com/reports/ECONorthwest_Low-Impact-Development-Economics-Literature-Review.pdf.
- Maryland Department of the Environment (MDE). 2000. Maryland Stormwater Design Manual. Maryland Department of the Environment. Water Management Administration. Baltimore, MD. Available Online: <http://www.mde.state.md.us/assets/document/sedimentstormwater/mancover.pdf>.
- Merrill, T.R., Coastal Georgia Regional Development Center (CGRDC) and EMC Engineering Services, Inc. 2006. *Green Growth Guidelines: A Low Impact Development Strategy for Coastal Georgia*. Prepared for: Georgia Department of Natural Resources (DNR) Coastal Management Program. Brunswick, GA. Available Online: <http://crd.dnr.state.ga.us/content/displaycontent.asp?txtDocument=969>.
- North Carolina Department of Environment and Natural Resources (NC DENR). 1998. *Stormwater Management Site Planning*. North Carolina Department of Environment and Natural Resources. Division of Water Quality. Raleigh, NC. Available Online: http://dem.ehnr.state.nc.us/su/PDF_Files/SW_Documents/Site_Planning_Document.pdf.
- North Carolina State University (NCSU). 2008. "Rainwater Harvesting at NCSU." North Carolina State University. Department of Biological and Agricultural Engineering. Stormwater Engineering Group. <http://www.bae.ncsu.edu/topic/waterharvesting/>. Accessed: July 28, 2008.
- U.S. Environmental Protection Agency (US EPA). 2008. "Environmental Benefits of Green Infrastructure." *Managing Wet Weather with Green Infrastructure*. <http://cfpub.epa.gov/npdes/greeninfrastructure/information.cfm#enviroben>. Accessed: June 27, 2008.

- Rupp, G. 1998. *Rainwater Harvesting Systems for Montana*. Montana State University Extension Service. Bozeman, MT. Available Online: <http://www.montana.edu/wwwpb/pubs/mt9707.html>.
- Schueler, T. 2000. "The Compaction of Urban Soils." *The Practice of Watershed Protection*. T. Schueler and H. Holland (Eds.). Center for Watershed Protection. Ellicott City, MD.
- Schueler, T. 1995. Site Planning for Urban Stream Protection. Prepared for: Metropolitan Washington Council of Governments. Center for Watershed Protection. Ellicott City, MD.
- Sullivan, W.C., F.E. Kuo and S.F. DePooter. 2003. "The Fruit of Urban Nature: Vital Neighborhood Spaces." *Environment and Behavior*. 36(5): 678-700. Available Online: <http://www.lhhl.uiuc.edu/all.scientific.articles.htm>.
- Taylor, A.F., A. Wiley, F.E. Kuo and W.C. Sullivan. 1998. "Growing Up in the Inner City: Green Spaces as Places to Grow." *Environment and Behavior*. 30(1): 3-27. Available Online: <http://www.lhhl.uiuc.edu/all.scientific.articles.htm>.
- Texas Water Development Board (TWDB). 2005. *The Texas Manual on Rainwater Harvesting*. 3rd Edition. Texas Water Development Board. Austin, TX. Available Online: http://www.twdb.state.tx.us/publications/reports/RainwaterHarvestingManual_3rdedition.pdf.
- U.S. Environmental Protection Agency (US EPA). 2008. "Environmental Benefits of Green Infrastructure." *Managing Wet Weather with Green Infrastructure*. <http://cfpub.epa.gov/npdes/greeninfrastructure/information.cfm#enviroben>. Accessed: June 27, 2008.
- U.S. Environmental Protection Agency (US EPA). 2007. *Reducing Stormwater Costs Through Low Impact Development (LID) Strategies and Practices*. EPA 841-F-07-006. U.S. Environmental Protection Agency. Washington, DC. Available Online: <http://www.epa.gov/owow/nps/lid/costs07/>.
- Jones, M.P. and W.F. Hunt. 2008. *Rainwater Harvesting: Guidance for Homeowners*. North Carolina Cooperative Extension Service Bulletin. Urban Waterways Series. AGW-588-11. North Carolina State University. Raleigh, NC. Available Online: <http://www.bae.ncsu.edu/stormwater/PublicationFiles/WaterHarvestHome2008.pdf>.
- Winer-Skonovd, R., D. Hirschman, H.Y. Kwon and C. Swann. 2006. *Synthesis of Existing Cost Information for LID vs. Conventional Practices*. Center for Watershed Protection. Ellicott City, MD.

THIS PAGE INTENTIONALLY LEFT BLANK

8.0 Stormwater Management Practices

8.1 Overview

Stormwater management practices (also known as *structural stormwater controls*, *structural stormwater best management practices* or *structural stormwater BMPs*) are engineered facilities designed to *intercept and manage* post-construction stormwater runoff rates, volumes and pollutant loads. Together with *green infrastructure practices*, which can be used to help *prevent* increases in post-construction stormwater runoff rates, volumes and pollutant loads, *stormwater management practices* can be used to help control and minimize the negative impacts of land development and nonpoint source pollution. Stormwater management practices can be used whenever green infrastructure practices cannot, on their own, be used to completely satisfy the post-construction stormwater management criteria (SWM Criteria) presented in this Coastal Stormwater Supplement (CSS):

- Stormwater Runoff Reduction (SWM Criteria #1): Reduce the stormwater runoff volume generated by the 85th percentile storm event (and the “first flush” of the stormwater runoff volume generated by all larger storm events) on a development site through the use of appropriate green infrastructure practices. In coastal Georgia, this equates to reducing the stormwater runoff volume generated by the 1.2 inch rainfall event (and the stormwater runoff generated by the first 1.2 inches of all larger rainfall events).
- Water Quality Protection (SWM Criteria #2): Adequately treat post-construction stormwater runoff before it is discharged from a development site. In coastal Georgia, this criteria can be met simply by satisfying the stormwater runoff reduction criteria (SWM Criteria #1). However, if any of the stormwater runoff generated by the 1.2 inch storm event (and the first 1.2 inches of all larger rainfall events), cannot be *reduced* on a development site, due to site characteristics or constraints, it should be *intercepted and treated* in one or more stormwater management practices that: (1) provide for at least an 80 percent reduction in TSS loads; and (2) reduce nitrogen and bacteria loads to the *maximum extent practical*.
- Aquatic Resource Protection (SWM Criteria #3): Protect coastal Georgia’s valuable aquatic resources from several other negative impacts of the land development process (e.g., complete loss or destruction, stream channel enlargement, increased salinity fluctuations) by: (1) protecting them from the direct impacts of the land development process through the use of better site planning techniques; (2) establishing a minimum 25-foot wide aquatic buffer around them (although a 75-foot wide aquatic buffer is preferred); (3) providing 24 hours of extended detention for the stormwater runoff volume generated by the 1-year, 24-hour storm event before it is discharged from a development site; and (4) providing velocity control and energy dissipation measures at all new and existing stormwater outfalls.
- Overbank Flood Protection (SWM Criteria #4): Prevent an increase in the duration, frequency and magnitude of damaging overbank flooding by controlling (attenuating) the peak discharge generated by the 25-year, 24-hour storm event under post-development conditions.
- Extreme Flood Protection (SWM Criteria #5): Prevent an increase in the duration, frequency and magnitude of dangerous extreme flooding by controlling (attenuating) the peak discharge generated by the 100-year, 24-hour storm event under post-development conditions.

This Section provides additional information about using *stormwater management practices* to help satisfy these SWM Criteria.

8.2 Recommended Stormwater Management Practices

The stormwater management practices *recommended* for use in coastal Georgia have been divided into two groups: (1) general application practices (also known as *general application controls*); and (2) limited application practices (also known as *limited application controls* or *detention controls*). Each of these groups is briefly described below.

8.2.1 General Application Practices

General application practices can be used to *treat* stormwater runoff and *manage* the post-construction stormwater runoff rates and volumes generated by larger, less frequent rainfall events (e.g., 1-year, 24-hour event, 25-year, 24-hour event). Several of these practices, namely bioretention areas, infiltration practices and dry swales, can also be used to reduce post-construction stormwater runoff volumes and, consequently, are also classified as runoff reducing low impact development practices (Section 7.8).

Since they can be used to both *treat* and *manage* post-construction stormwater runoff, it is *recommended* that general application practices be used whenever green infrastructure practices cannot, on their own, be used to completely satisfy the stormwater runoff reduction (SWM Criteria #1), stormwater quality protection (SWM Criteria #2), aquatic resource protection (SWM Criteria #3), overbank flood protection (SWM Criteria #4) and extreme flood protection (SWM Criteria #5) criteria presented in this CSS. The general application practices *recommended* for use in coastal Georgia include:

Stormwater Ponds

Stormwater ponds (Figure 8.1) are stormwater detention basins that have a permanent pool of water. Post-construction stormwater runoff is conveyed into the pool, where it is both detained and treated over an extended period of time. The types of stormwater ponds that are *recommended* for use in coastal Georgia include:

- Wet Ponds
- Wet Extended Detention Ponds
- Micropool Extended Detention Ponds
- Multiple Pond Systems

Stormwater Wetlands

Stormwater wetlands (Figure 8.2) are constructed wetland systems built for stormwater management purposes. Stormwater wetlands typically consist of a combination of open water,



Figure 8.1: Stormwater Pond
(Source: Atlanta Regional Commission, 2001)



Figure 8.2: Stormwater Wetland
(Source: Merrill et al., 2006)

shallow marsh and semi-wet areas, and can be used to both detain and treat post-construction stormwater runoff. The types of stormwater wetlands that are *recommended* for use in coastal Georgia include:

- Shallow Wetlands
- Extended Detention Shallow Wetlands
- Pond/Wetland Systems
- Pocket Wetlands

Bioretention Areas

Bioretention areas (Figure 8.3), which may also be classified as a low impact development practice (Section 7.8.13), are shallow depressional areas that use an engineered soil mix and vegetation to intercept and treat post-construction stormwater runoff. After passing through a bioretention area, stormwater runoff may be returned to the stormwater conveyance system through an underdrain, or may be allowed to fully or partially infiltrate into the surrounding soils.



Figure 8.3: Bioretention Area
(Source: Center for Watershed Protection)

Filtration Practices

Filtration practices are multi-chamber structures designed to treat post-construction stormwater runoff using the physical processes of screening and filtration. Sand is typically used as the filter media. After passing through a filtration practice, stormwater runoff is typically returned to the conveyance system through an underdrain. The filtration practices that are *recommended* for use in coastal Georgia include:

- Surface Sand Filter
- Perimeter Sand Filter

Infiltration Practices

Infiltration practices (Figure 8.4), which may also be classified as a runoff reducing low impact development practice (Section 7.8.14), are shallow excavations, typically filled with stone or an engineered soil mix, that are designed to intercept and temporarily store post-construction stormwater runoff until it infiltrates into the surrounding soils. The infiltration practices that are *recommended* for use in coastal Georgia include:

- Infiltration Trench
- Infiltration Basin



Figure 8.4: Infiltration Trench
(Source: Center for Watershed Protection)

Swales

Swales (Figure 8.5) are vegetated open channels that are designed to manage post-construction stormwater runoff within wet or dry cells formed by check dams or other control structures (e.g., culverts). The two types of swales that are *recommended* for use in coastal Georgia include:

- Dry Swale
- Wet Swale

Because of their ability to reduce annual stormwater runoff volumes and pollutant loads, dry swales may also be classified as a low impact development practice (Section 7.8.15).



Figure 8.5: Wet Swale
(Source: Center for Watershed Protection)

8.2.2 Limited Application Practices

There are two groups of limited application stormwater management practices that can be used in coastal Georgia, each of which is briefly described below:

Water Quantity Management Practices

Water quantity management practices (Figure 8.6) can only be used to *manage* the post-construction stormwater runoff rates and volumes generated by larger, less frequent rainfall events (e.g., 1-year, 24-hour event, 25-year, 24-hour event). They provide little, if any, stormwater runoff reduction or stormwater treatment. Consequently, it is *recommended* that they be used only on a limited basis, and only when green infrastructure practices and general application stormwater management practices cannot be used to completely satisfy the aquatic resource protection (SWM Criteria #3), overbank flood protection (SWM Criteria #4) and extreme flood protection (SWM Criteria #5) criteria presented in this CSS. The water quantity management practices that may be used in coastal Georgia include:

- Dry Detention Basins
- Dry Extended Detention Basins
- Multi-Purpose Detention Areas
- Underground Detention Systems



Figure 8.6: Dry Detention Basin Used to Provide Water Quantity Management
(Source: Center for Watershed Protection)

Water Quality Management Practices

Water quality management practices can only be used to *treat* post-construction stormwater runoff. They typically have high or special maintenance requirements, provide little, if any, stormwater runoff reduction, and cannot be used to *manage* the post-construction stormwater runoff rates and volumes generated by larger, less frequent rainfall events (e.g., 1-year, 24-hour event, 25-year, 24-hour event). Consequently, it is *recommended* that they be used only on a limited basis, and only when green infrastructure practices and general stormwater

management application practices cannot be used to completely satisfy the stormwater runoff reduction (SWM Criteria #1) and stormwater quality protection criteria (SWM Criteria #2) presented in this CSS. The water quality management practices that may be used in coastal Georgia include:

- Organic Filters
- Underground Filters
- Submerged Gravel Wetlands
- Gravity (Oil-Grit) Separators
- Alum Treatment Systems
- Proprietary Systems

8.3 Other Stormwater Management Practices

8.3.1 Not Recommended Stormwater Management Practices

Proprietary catch basin inserts and media filter systems are not recommended for use in coastal Georgia. These proprietary devices tend to clog very easily and typically carry a very high long-term maintenance burden. Although they are not recommended for use on new development and redevelopment sites, these proprietary devices may be used in retrofit applications where surface space is at a premium.

8.3.2 New and Innovative Stormwater Management Practices

The use of new and innovative stormwater management practices is encouraged in coastal Georgia, provided that their ability to satisfy the stormwater management and site planning and design criteria presented in this CSS has been sufficiently documented. At its discretion, a local development review authority may allow for the use of a stormwater management practice that is not discussed in this CSS. However, local development review authorities are encouraged not to do so until they are provided with reliable information about practice performance and information about practice design and maintenance requirements.

New and innovative stormwater management practices will not be added to this CSS until reliable, independently derived performance monitoring data confirm their ability to satisfy the stormwater management and site planning and design criteria presented in this CSS. Appendix C outlines a stormwater management monitoring protocol that can be used to help document the performance of new and innovative stormwater management practices in coastal Georgia.

8.4 Applying Stormwater Management Practices During the Site Planning & Design Process

A procedure that can be used to apply stormwater management practices to a development site during the site planning and design process is illustrated in Figure 8.7 and briefly outlined below.

8.4.1 Step 4.6: Apply Stormwater Management Practices

After low impact development practices have been distributed across the development site, and it has been determined that the SWM Criteria that apply to the development site cannot be satisfied exclusively through the use of green infrastructure practices, a site planning and design team should be able to begin applying stormwater management practices to the site to further *manage* post-construction stormwater runoff rates, volumes and pollutant loads. Stormwater management practices should be placed downstream of any previously applied green infrastructure practices to form what are known as “stormwater management trains” (Figure 8.8).

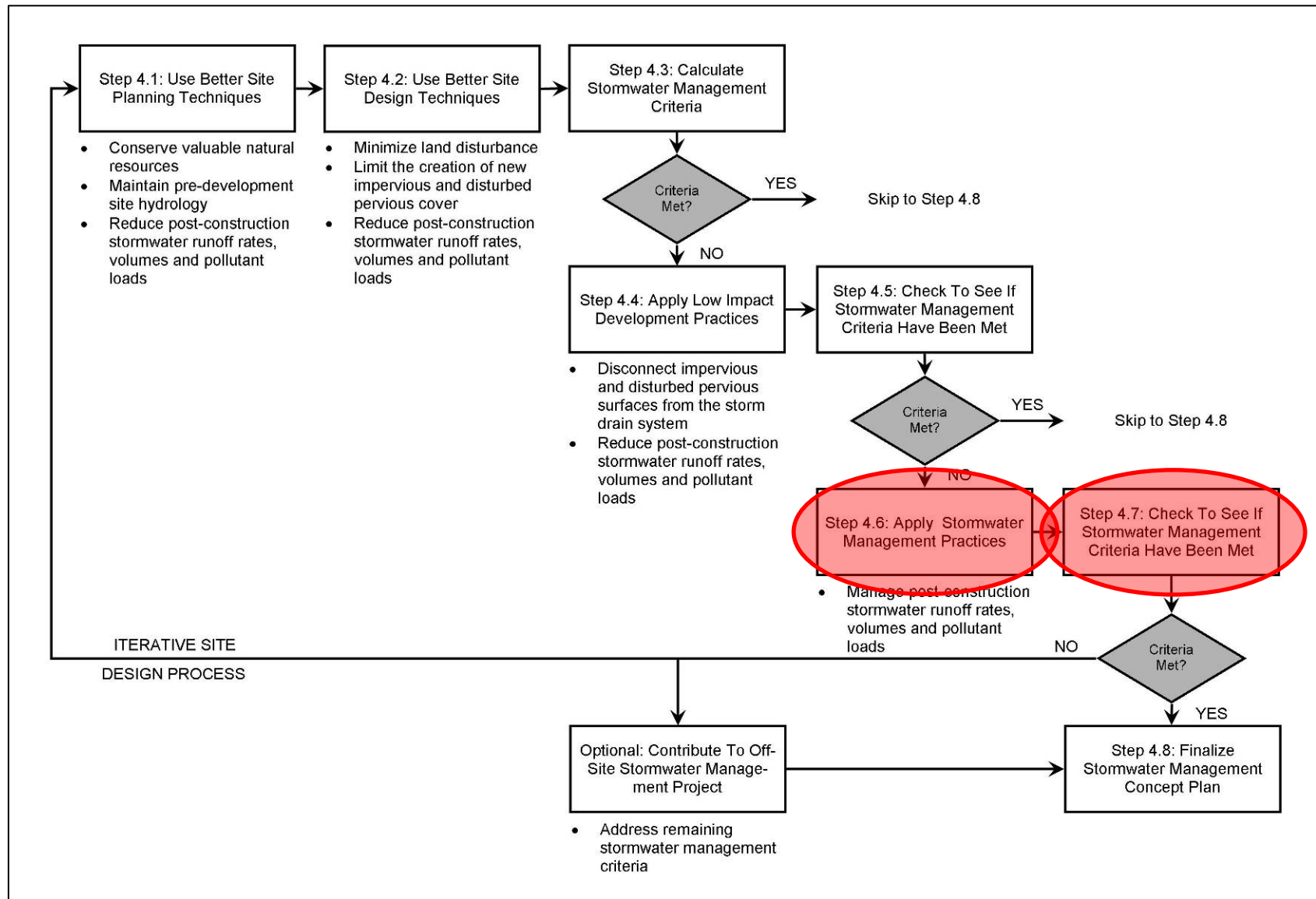

Figure 8.7: Using Stormwater Management Practices During the Creation of a Stormwater Management Concept Plan

(Source: Center for Watershed Protection)

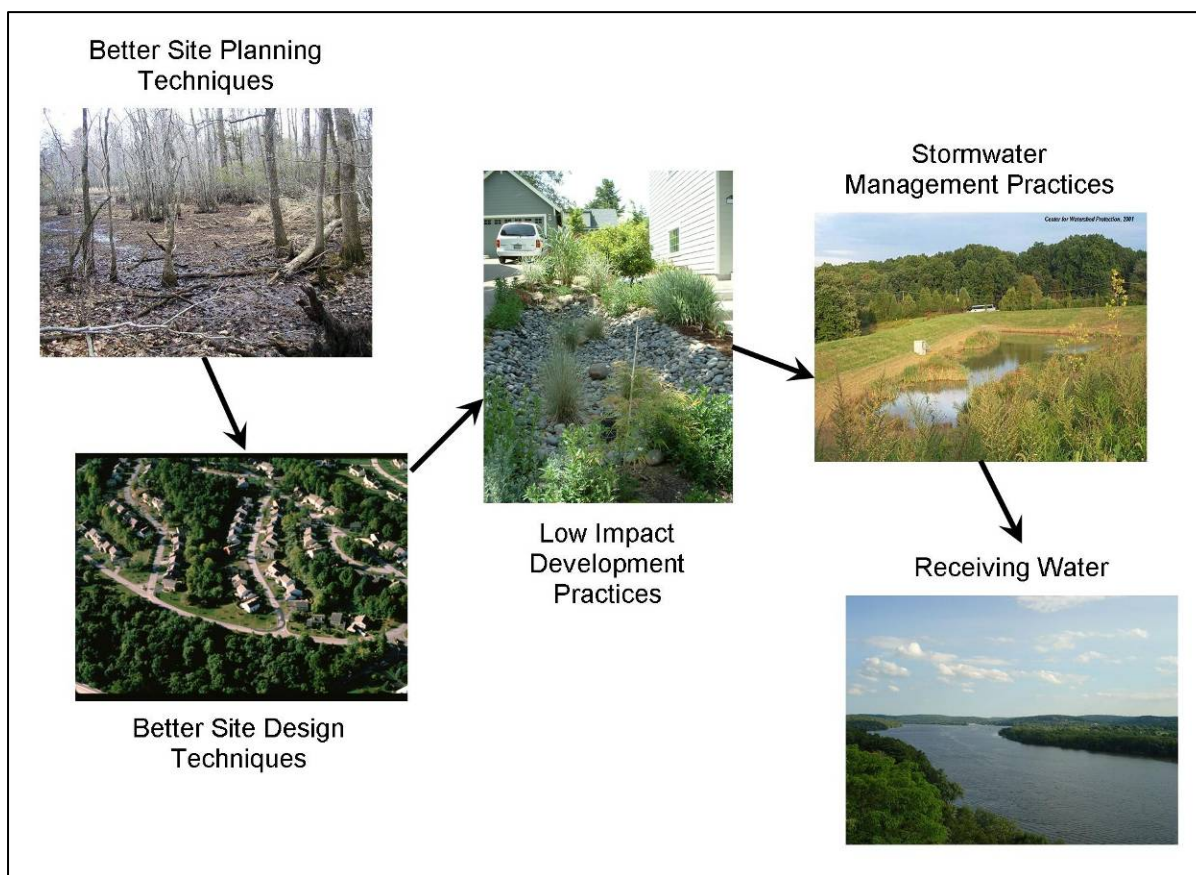

Figure 8.8: Stormwater Management Train

(Source: Center for Watershed Protection)

It is important to note that the structure of the “stormwater management train” illustrated in Figure 8.8 mirrors the step-wise process of developing a stormwater management concept plan for a development site. The position of stormwater management practices within the “stormwater management train” reflects the notion that they should not be used on a development site until it has been determined that the SWM Criteria presented in this CSS cannot be satisfied exclusively through the use of green infrastructure practices.

When applying stormwater management practices to a development site, they should be placed in drainage or maintenance easements and included in all stormwater management system inspection and maintenance plans (SP&D Criteria #6). Additional information about the use of stormwater management practices, including information about their proper application and design, can be found in Sections 8.6-8.7.

8.4.2 Step 4.7: Check to See If Stormwater Management Criteria Have Been Met

Once stormwater management practices have been applied to a development site, site planning and design teams should check to make sure that all of the SWM Criteria that apply to the site have been completely satisfied. If they have not, they will need to go back to the development plan and apply additional low impact development and stormwater management practices to further *reduce* and *manage* post-construction stormwater runoff rates, volumes and pollutant loads on the development site.

On many development sites, the process of putting together a development plan will be an iterative process. When compliance with the SWM Criteria presented in the CSS is not achieved on the first try, site planning and design teams should return to earlier steps in the process to explore alternative site layouts and different combinations of green infrastructure and stormwater management practices.

If the SWM Criteria presented in this CSS cannot, due to site characteristics or constraints, be satisfied through the use of *on-site* green infrastructure and stormwater management practices, developers may be able to achieve compliance by implementing or contributing to an *off-site* stormwater management project. Off-site projects can be an extremely attractive compliance option on redevelopment sites where space for on-site green infrastructure and stormwater management practices is extremely limited. If a developer is interested in using an off-site stormwater management project to help satisfy the SWM Criteria presented in this CSS, they are encouraged to consult with the local development review authority.

8.5 Stormwater Management Practice Selection

A screening process that can be used to help decide what stormwater management practices can be used on a development site is outlined below. This process is intended to assist site planning and design teams in selecting the most appropriate stormwater management practices for use on a development site.

In general, the following information should be considered when deciding what stormwater management practices can be used on a development site:

- Ability to Help Satisfy the Stormwater Management Criteria
- Overall Feasibility
- Site Applicability

In addition, site planning and design teams should consider how the following site characteristics and constraints, which are commonly encountered in coastal Georgia, will influence the use of stormwater management practices on a development site:

- Poorly drained soils, such as hydrologic soil group C and D soils
- Well drained soils, such as hydrologic soil group A and B soils
- Flat terrain
- Shallow water table
- Tidally-influenced drainage

Additional information on a step-wise process that can be used to decide what stormwater management practices can be used on a development site is provided below. The process uses three screening matrices to evaluate the feasibility and applicability of the various stormwater management practices recommended for use in coastal Georgia.

8.5.1 Step 1: Evaluate Ability to Help Satisfy the Stormwater Management Criteria

Through the use of the first screening matrix (Table 8.1), site planning and design teams can evaluate how each of the stormwater management practices can be used to help satisfy the post-construction stormwater management criteria that apply to a development site. Additional information about each of the screening categories included in the matrix is provided below.

- Stormwater Runoff Reduction: This column indicates the stormwater management “credit” that can be applied toward the stormwater runoff reduction criteria (SWM Criteria #1) if the stormwater management practice is used on the development site.
- Water Quality Protection: This column indicates the stormwater management “credit” that can be applied toward the water quality protection criteria (SWM Criteria #2) if the stormwater management practice is used on the development site.
- Aquatic Resource Protection: This column indicates the stormwater management “credit” that can be applied toward the aquatic resource protection criteria (SWM Criteria #3) if the stormwater management practice is used on the development site.
- Overbank Flood Protection: This column indicates the stormwater management “credit” that can be applied toward the overbank flood protection criteria (SWM Criteria #4) if the stormwater management practice is used on the development site.
- Extreme Flood Protection: This column indicates the stormwater management “credit” that can be applied toward the extreme flood protection criteria (SWM Criteria #5) if the stormwater management practice is used on the development site.

Table 8.1: How Stormwater Management Practices Can Be Used to Help Satisfy the Stormwater Management Criteria

Stormwater Management Practice	Stormwater Runoff Reduction	Water Quality Protection	Aquatic Resource Protection	Overbank Flood Protection	Extreme Flood Protection
General Application Practices					
Stormwater Ponds	"Credit": None	"Credit": Assume that a <i>stormwater pond</i> provides an 80% reduction in TSS loads ¹ , a 30% reduction in TN loads ² and a 70% reduction in bacteria loads ¹ .	"Credit": A <i>stormwater pond</i> can be designed to provide 24-hours of extended detention for the aquatic resource protection volume (ARP _v).	"Credit": A <i>stormwater pond</i> can be designed to attenuate the overbank peak discharge (Q _{p25}) on a development site.	"Credit": A <i>stormwater pond</i> can be designed to attenuate the extreme peak discharge (Q _{p100}) on a development site.
Stormwater Wetlands	"Credit": None	"Credit": Assume that a <i>stormwater wetland</i> provides an 80% reduction in TSS loads ¹ , a 30% reduction in TN loads ² and an 80% reduction in bacteria loads ¹ .	"Credit": A <i>stormwater wetland</i> can be designed to provide 24-hours of extended detention for the aquatic resource protection volume (ARP _v).	"Credit": A <i>stormwater wetland</i> can be designed to attenuate the overbank peak discharge (Q _{p25}) on a development site.	"Credit": A <i>stormwater wetland</i> can be designed to attenuate the extreme peak discharge (Q _{p100}) on a development site.
Bioretention Areas, No Underdrain	"Credit": Subtract 100% of the storage volume provided by a non-underdrained <i>bioretention area</i> from the runoff reduction volume (RR _v) conveyed through the <i>bioretention area</i> .	"Credit": Assume that a <i>bioretention area</i> provides an 80% reduction in TSS loads ¹ , a 60% reduction in TN loads ² and an 80% reduction in bacteria loads [#] .	"Credit": Although uncommon, on some development sites, a <i>bioretention area</i> can be designed to provide 24-hours of extended detention for the aquatic resource protection volume (ARP _v).	"Credit": Although relatively rare, on some development sites, a <i>bioretention area</i> can be designed to attenuate the overbank peak discharge (Q _{p25}).	"Credit": Although relatively rare, on some development sites, a <i>bioretention area</i> can be designed to attenuate the extreme peak discharge (Q _{p100}).
Bioretention Areas, Underdrain	"Credit": Subtract 50% of the storage volume provided by an underdrained <i>bioretention area</i> from the runoff reduction volume (RR _v) conveyed through the <i>bioretention area</i> .				
Filtration Practices	"Credit": None	"Credit": Assume that a <i>filtration practice</i> provides an 80% reduction in TSS loads ¹ , a 30% reduction in TN loads ² and a 40% reduction in bacteria loads ¹ .	"Credit": Although uncommon, on some development sites, a <i>filtration practice</i> can be designed to provide 24-hours of extended detention for the aquatic resource protection volume (ARP _v).	"Credit": Although relatively rare, on some development sites, a <i>filtration practice</i> can be designed to attenuate the overbank peak discharge (Q _{p25}).	"Credit": Although relatively rare, on some development sites, a <i>filtration practice</i> can be designed to attenuate the extreme peak discharge (Q _{p100}).

Table 8.1: How Stormwater Management Practices Can Be Used to Help Satisfy the Stormwater Management Criteria

Stormwater Management Practice	Stormwater Runoff Reduction	Water Quality Protection	Aquatic Resource Protection	Overbank Flood Protection	Extreme Flood Protection
Infiltration Practices	"Credit": Subtract 100% of the storage volume provided by an <i>infiltration practice</i> from the runoff reduction volume (RR _v) conveyed through the <i>infiltration practice</i> .	"Credit": Assume that an <i>infiltration practice</i> provides an 80% reduction in TSS loads ¹ , an 60% reduction in TN loads ² and an 80% reduction in bacteria loads [#] .	"Credit": Although uncommon, on some development sites, an <i>infiltration practice</i> can be designed to provide 24-hours of extended detention for the aquatic resource protection volume (ARP _v).	"Credit": Although relatively rare, on some development sites, an <i>infiltration practice</i> can be designed to attenuate the overbank peak discharge (Q _{p25}).	"Credit": Although relatively rare, on some development sites, an <i>infiltration practice</i> can be designed to attenuate the extreme peak discharge (Q _{p100}).
Dry Swales, No Underdrain	"Credit": Subtract 100% of the storage volume provided by a non-underdrained <i>dry swale</i> from the runoff reduction volume (RR _v) conveyed through the <i>dry swale</i> .	"Credit": Assume that a <i>dry swale</i> provides an 80% reduction in TSS loads ¹ , a 50% reduction in TN loads ² and a 60% reduction in bacteria loads [#] .	"Credit": Although uncommon, on some development sites, a <i>dry swale</i> can be designed to provide 24-hours of extended detention for the aquatic resource protection volume (ARP _v).	"Credit": Although relatively rare, on some development sites, a <i>dry swale</i> can be designed to attenuate the overbank peak discharge (Q _{p25}).	"Credit": Although relatively rare, on some development sites, a <i>dry swale</i> can be designed to attenuate the extreme peak discharge (Q _{p100}).
Dry Swales, Underdrain	"Credit": Subtract 50% of the storage volume provided by an underdrained <i>dry swale</i> from the runoff reduction volume (RR _v) conveyed through the <i>dry swale</i> .				
Wet Swales	"Credit": None	"Credit": Assume that a <i>wet swale</i> provides an 80% reduction in TSS loads ¹ , a 25% reduction in TN loads ² and a 40% reduction in bacteria loads [#] .	"Credit": Although uncommon, on some development sites, a <i>wet swale</i> can be designed to provide 24-hours of extended detention for the aquatic resource protection volume (ARP _v).	"Credit": Although uncommon, on some development sites, a <i>wet swale</i> can be designed to attenuate the overbank peak discharge (Q _{p25}).	"Credit": Although uncommon, on some development sites, a <i>wet swale</i> can be designed to attenuate the extreme peak discharge (Q _{p100}).
Limited Application Practices					
Water Quantity Management Practices					
Dry Detention Basins	"Credit": None	"Credit": None	"Credit": None	"Credit": A <i>dry detention basin</i> can be used to attenuate the overbank peak discharge (Q _{p25}) on a development site.	"Credit": A <i>dry detention basin</i> can be used to attenuate the extreme peak discharge (Q _{p100}) on a development site.

Table 8.1: How Stormwater Management Practices Can Be Used to Help Satisfy the Stormwater Management Criteria

Stormwater Management Practice	Stormwater Runoff Reduction	Water Quality Protection	Aquatic Resource Protection	Overbank Flood Protection	Extreme Flood Protection
Dry Extended Detention Basins	"Credit": None	"Credit": Assume that a <i>dry extended detention basin</i> provides a 40% reduction in TSS loads ¹ , a 10% reduction in TN loads ² and a 20% reduction in bacteria loads [#] .	"Credit": A <i>dry extended detention basin</i> can be used to provide 24-hours of extended detention for the aquatic resource protection volume (ARP _v).	"Credit": A <i>dry extended detention basin</i> can be used to attenuate the overbank peak discharge (Q _{p25}) on a development site.	"Credit": A <i>dry extended detention basin</i> can be used to attenuate the extreme peak discharge (Q _{p100}) on a development site.
Multi-Purpose Detention Areas	"Credit": None	"Credit": None	"Credit": None	"Credit": A <i>multi-purpose detention area</i> can be used to attenuate the overbank peak discharge (Q _{p25}) on a development site.	"Credit": A <i>multi-purpose detention area</i> can be used to attenuate the overbank peak discharge (Q _{p25}) on a development site.
Underground Detention Systems	"Credit": None	"Credit": None	"Credit": An <i>underground detention system</i> can be used to provide 24-hours of extended detention for the aquatic resource protection volume (ARP _v).	"Credit": An <i>underground detention system</i> can be used to attenuate the overbank peak discharge (Q _{p25}) on a development site.	"Credit": An <i>underground detention system</i> can be used to attenuate the extreme peak discharge (Q _{p100}) on a development site.
Water Quality Management Practices					
Organic Filters	"Credit": None	"Credit": Assume that an <i>organic filter</i> provides an 80% reduction in TSS loads ³ , a 40% reduction in TN loads ³ and a 40% reduction in bacteria loads ¹ .	"Credit": None	"Credit": None	"Credit": None
Underground Filters	"Credit": None	"Credit": Assume that an <i>underground filter</i> provides an 80% reduction in TSS loads ¹ , a 30% reduction in TN loads ¹ and a 40% reduction in bacteria loads ¹ .	"Credit": None	"Credit": None	"Credit": None

Table 8.1: How Stormwater Management Practices Can Be Used to Help Satisfy the Stormwater Management Criteria

Stormwater Management Practice	Stormwater Runoff Reduction	Water Quality Protection	Aquatic Resource Protection	Overbank Flood Protection	Extreme Flood Protection
Submerged Gravel Wetlands	"Credit": None	"Credit": Assume that a <i>submerged gravel wetland</i> provides an 80% reduction in TSS loads ³ , a 20% reduction in TN loads ³ and a 40% reduction in bacteria loads [#] .	"Credit": None	"Credit": None	"Credit": None
Gravity (Oil-Grit) Separators	"Credit": None	"Credit": Assume that a <i>gravity (oil-grit) separator</i> provides a 40% reduction in TSS loads [#] , a 10% reduction in TN loads [#] and a 20% reduction in bacteria loads [#] .	"Credit": None	"Credit": None	"Credit": None
Alum Treatment Systems	"Credit": None	"Credit": Assume that an <i>alum treatment system</i> provides a 90% reduction in TSS loads ⁴ , a 60% reduction in TN loads ⁴ and a 90% reduction in bacteria loads ⁴ .	"Credit": None	"Credit": None	"Credit": None
Proprietary Systems	"Credit": TBD*	"Credit": TBD*	"Credit": TBD*	"Credit": TBD*	"Credit": TBD*
<p>Notes:</p> <p>1 National Pollutant Removal Database, Version 3.0 (Fraley-McNeal et al., 2007)</p> <p>2 Runoff Reduction Technical Memorandum (Hirschman et al., 2008)</p> <p>3 National Pollutant Removal Database, Version 2.0 (Winer, 2000)</p> <p>4 Georgia Stormwater Management Manual, Volume 2 (ARC, 2001)</p> <p># Load reduction estimates are based on a very limited amount of data and should be considered to be provisional estimates.</p> <p>* Information about how specific proprietary devices and systems can be used to help satisfy the stormwater management criteria must be provided by the manufacturer and should be verified using independently-reviewed performance monitoring data and calculations. See Appendix D for more information about monitoring the performance of individual stormwater management practices.</p>					

8.5.2 Step 2: Evaluate Overall Feasibility

Through the use of the second screening matrix (Table 8.2), site planning and design teams can evaluate the overall feasibility of applying each of the stormwater management practices on a development site. Additional information about each of the screening categories included in the matrix is provided below.

- Drainage Area: This column describes how large of a contributing drainage area each stormwater management practice can realistically handle. It indicates the maximum size of the contributing drainage area that each stormwater management practice should be designed to “receive” stormwater runoff from.
- Area Required: This column indicates how much space the stormwater management practice typically consumes on a development site.
- Slope: This column describes the influence that site slope can have on the performance of the stormwater management practice. It indicates the maximum or minimum slope on which the stormwater management practice can be installed.
- Minimum Head: This column provides an estimate of the minimum amount of elevation difference needed within the stormwater management practice, from the inflow to the outflow, to allow for gravity operation.
- Minimum Depth to Water Table: This column indicates the minimum distance that should be provided between the bottom of the stormwater management practice and the top of the water table.
- Soils: This column describes the influence that the underlying soils (i.e., hydrologic soil groups) can have on the performance of the stormwater management practice.

Table 8.2: Factors to Consider When Evaluating the Overall Feasibility of Stormwater Management Practices

Stormwater Management Practice	Drainage Area	Area Required	Slope	Minimum Head	Minimum Depth to Water Table	Soils
General Application Practices						
Stormwater Ponds	No restrictions, although a contributing drainage area of between 10 to 25 acres or a shallow water table is typically needed to maintain a permanent pool	2-3% of contributing drainage area	15%	6 to 8 feet	No restrictions	No restrictions
Stormwater Wetlands	No restrictions, although a contributing drainage area of between 5 to 25 acres or a shallow water table is typically needed to maintain a permanent water surface	3-5% of contributing drainage area	15%	2 to 5 feet	No restrictions	No restrictions
Bioretention Areas	5 acres	5-10% of contributing drainage area	6%	42 to 48 inches ¹	2 feet	Should drain within 48 hours of end of rainfall event
Filtration Practices	2 to 10 acres	3-5% of contributing drainage area	6%	2 to 5 feet	2 feet	Should drain within 36 hours of end of rainfall event
Infiltration Practices	2 to 5 acres	5% of contributing drainage area	6%	42 to 48 inches ¹	2 feet	Should drain within 48 hours of end of rainfall event
Dry Swales	5 acres	5-10% of contributing drainage area	0.5% to 4%, although 1% to 2% is recommended	36 to 48 inches ¹	2 feet	Should drain within 48 hours of end of rainfall event
Wet Swales	5 acres	10-20% of contributing drainage area	0.5% to 4%, although 1% to 2% is recommended	1 to 2 feet	No restrictions	No restrictions
Limited Application Practices						
Water Quantity Management Practices						
Dry Detention Basins	No restrictions	1-3% of contributing drainage area	15%	4 to 8 feet	2 feet	No restrictions
Dry Extended Detention Basins	No restrictions	1-3% of contributing drainage area	15%	4 to 8 feet	2 feet	No restrictions

Table 8.2: Factors to Consider When Evaluating the Overall Feasibility of Stormwater Management Practices						
Stormwater Management Practice	Drainage Area	Area Required	Slope	Minimum Head	Minimum Depth to Water Table	Soils
Multi-Purpose Detention Areas	No restrictions	1-3% of contributing drainage area	15%	4 to 8 feet	2 feet	No restrictions
Underground Detention Systems	No restrictions	N/A	15%	4 to 8 feet	2 feet	No restrictions
Water Quality Management Practices						
Organic Filters	10 acres	3-5% of contributing drainage area	6%	2 to 5 feet	2 feet	Should drain within 36 hours of end of rainfall event
Underground Filters	10 acres	N/A	6%	2 to 5 feet	2 feet	Should drain within 36 hours of end of rainfall event
Submerged Gravel Wetlands	5 acres	3-5% of contributing drainage area	0.5% to 4%, although 1% to 2% is recommended	2 to 5 feet	No restrictions	No restrictions
Gravity (Oil-Grit) Separators	5 acres	N/A	6%	4 feet	2 feet	No restrictions
Alum Treatment Systems	No restrictions, although a contributing drainage area of between 10 to 25 acres or a shallow water table is typically needed to construct a stormwater pond	N/A	N/A	6 to 8 feet typically needed to construct a stormwater pond	N/A	N/A
Proprietary Systems	TBD*	TBD*	TBD*	TBD*	TBD*	TBD*
Notes: 1 Criteria may be relaxed on development sites that have a shallow water table. See profile sheets provided in Sections 8.6-8.7 for additional information. * Information about the factors to consider when evaluating the overall feasibility of specific proprietary devices and systems can be obtained directly from the manufacturer.						

8.5.3 Step 3: Evaluate Site Applicability

Through the use of the third screening matrix (Table 8.3), site planning and design teams can evaluate the applicability of each of the stormwater management practices on a particular development site. Additional information about each of the screening categories included in the matrix is provided below.

- Rural Use: This column indicates whether or not the stormwater management practice is suitable for use in rural areas and on low-density development sites.
- Suburban Use: This column indicates whether or not the stormwater management practice is suitable for use in suburban areas and on medium-density development sites.
- Urban Use: This column identifies the stormwater management practices that are suitable for use in urban and ultra-urban areas where space is at a premium.
- Construction Cost: This column assesses the relative construction cost of each of the stormwater management practices.
- Maintenance: This column assesses the relative maintenance burden associated with each stormwater management practice. It is important to note that *all* stormwater management practices require some kind of routine inspection and maintenance.

Table 8.3: Factors to Consider When Evaluating the Applicability of Stormwater Management Practices on a Development Site					
Stormwater Management Practice	Rural Use	Suburban Use	Urban Use	Construction Cost	Maintenance
General Application Practices					
Stormwater Ponds	✓	✓		Low	Low
Stormwater Wetlands	✓	✓		Low	Medium
Bioretention Areas	✓	✓	✓	Medium	Medium
Filtration Practices	*	✓	✓	High	High
Infiltration Practices	✓	✓	✓	Medium	High
Dry Swales	✓	✓	*	Medium	Medium
Wet Swales	✓	✓	*	Medium	Medium
Limited Application Practices					
Water Quantity Practices					
Dry Detention Basins	✓	✓		Low	Low
Dry Extended Detention Basins	✓	✓		Low	Low
Multi-Purpose Detention Areas	*	✓	✓	Low	Low
Underground Detention Systems			✓	High	Medium
Water Quality Practices					
Organic Filters	*	*	✓	High	High
Underground Filters			✓	High	High
Submerged Gravel Wetlands	*	*	✓	High	High
Gravity (Oil-Grit) Separators	*	*	✓	High	High
Alum Treatment Systems	✓	✓		High	High
Proprietary Systems	*	*	✓	TBD*	TBD*
Notes: ✓ = Suitable for use on development sites located in these areas. * = Under certain situations, can be used on development sites located in these areas. * Information about the factors to consider when evaluating the applicability of specific proprietary devices and systems can be obtained directly from the manufacturer.					

8.6 General Application Stormwater Management Practice Profile Sheets

This Section contains profile sheets that provide information about the general application stormwater management practices that are *recommended* for use in coastal Georgia. The profile sheets describe each of the stormwater management practices, discuss how to properly apply and design them on development sites and provide information about how they can be used to help satisfy the SWM Criteria presented in this CSS. The stormwater management practices profiled in this Section include:

General Application Practices

- 8.6.1 Stormwater Ponds
- 8.6.2 Stormwater Wetlands
- 8.6.3 Bioretention Areas
- 8.6.4 Filtration Practices
- 8.6.5 Infiltration Practices
- 8.6.6 Swales

NOTE: Much of the information presented in the following profile sheets can also be found in Section 3.2 of Volume 2 of the *Georgia Stormwater Management Manual* (ARC, 2001). It is has been updated with new design guidance and new information about the stormwater management "credits" associated with each of these stormwater management practices. The information is presented here to prevent the reader from having to leave the CSS during the site planning and design process.

THIS PAGE INTENTIONALLY LEFT BLANK

8.6.1 Stormwater Ponds

Description

Stormwater ponds are stormwater detention basins that have a permanent pool of water. Post-construction stormwater runoff is conveyed into the pool, where it is detained and treated over an extended period of time, primarily through gravitational settling and biological uptake, until it is displaced by stormwater runoff from the next rain event. Temporary storage (i.e., live storage) can be provided above the permanent pool for stormwater quantity control. This allows stormwater ponds to both *treat* stormwater runoff and *manage* the stormwater runoff rates and volumes generated by larger, less frequent rainfall events on development sites.



(Source: Atlanta Regional Commission, 2001)

<p style="text-align: center;"><u>KEY CONSIDERATIONS</u></p> <p>DESIGN CRITERIA:</p> <ul style="list-style-type: none"> • Contributing drainage area of 25 acres or more typically needed for wet and wet extended detention ponds; 10 acres or more typically needed for micropool extended detention pond • A sediment forebay (or equivalent pretreatment) should be provided upstream of all ponds • Permanent pools should be designed to be between 3 and 8 feet deep • Length to width ratio should be at least 1.5:1 (L:W), although a length to width ratio of 3:1 (L:W) or greater is preferred • Side slopes should not exceed 3:1 (H:V) <p>BENEFITS:</p> <ul style="list-style-type: none"> • Provides moderate to high removal of many of the pollutants of concern contained in post-construction stormwater runoff • Can be attractively integrated into a development site and designed to provide some wildlife habitat <p>LIMITATIONS:</p> <ul style="list-style-type: none"> • Provides minimal reduction of post-construction stormwater runoff volumes • Stormwater pond design can be challenging in flat terrain 	<p style="text-align: center;"><u>STORMWATER MANAGEMENT "CREDITS"</u></p> <p>Runoff Reduction</p> <ul style="list-style-type: none"> <input checked="" type="checkbox"/> Water Quality Protection <input checked="" type="checkbox"/> Aquatic Resource Protection <input checked="" type="checkbox"/> Overbank Flood Protection <input checked="" type="checkbox"/> Extreme Flood Protection <p><input checked="" type="checkbox"/> = practice has been assigned quantifiable stormwater management "credits" that can be used to address this SWM Criteria</p>
<p style="text-align: center;"><u>SITE APPLICABILITY</u></p> <ul style="list-style-type: none"> <input checked="" type="checkbox"/> Rural Use <input checked="" type="checkbox"/> Suburban Use Urban Use <input type="checkbox"/> L Construction Cost <input type="checkbox"/> L Maintenance <input type="checkbox"/> H Area Required 	<p style="text-align: center;"><u>STORMWATER MANAGEMENT PRACTICE PERFORMANCE</u></p> <p>Runoff Reduction 0% - Annual Runoff Volume 0% - Runoff Reduction Volume</p> <p>Pollutant Removal¹ 80% - Total Suspended Solids 50% - Total Phosphorus 30% - Total Nitrogen 50% - Metals 70% - Pathogens</p> <p>1 = expected annual pollutant load removal</p>

Discussion

Stormwater ponds (also known as *retention ponds*, *wet ponds*, or *wet extended detention ponds*) are stormwater detention basins that are designed to have a permanent pool of water (i.e., dead storage) throughout the year. Post-construction stormwater runoff is conveyed into the pool, where it is detained and treated over an extended period of time, primarily through gravitational settling and biological uptake, until it is displaced by stormwater runoff from the next rain event. The permanent pool also helps protect deposited sediments from resuspension. Above the permanent pool, temporary storage (i.e., live storage) can be provided for stormwater quantity control.

Stormwater ponds treat post-construction stormwater runoff through a combination of physical, chemical and biological processes. The primary pollutant removal mechanism at work is gravitational settling, which works to remove particulate matter, organic matter, metals and bacteria as stormwater runoff is conveyed through the permanent pool. Another primary pollutant removal mechanism at work in stormwater ponds is biological uptake of nutrients by algae and wetland vegetation. Volatilization and other chemical processes also work to break down and eliminate a number of other stormwater pollutants (e.g., hydrocarbons) in stormwater ponds.

Stormwater ponds are among the most common stormwater management practices used in coastal Georgia and the rest of the United States. They are typically created by excavating a depression area to create "dead storage" below the water surface elevation of the receiving storm drain system, stream or other aquatic resource. A well-designed pond can be attractively integrated into a development site as a landscaping feature and, if appropriately designed, sited and landscaped, can provide some wildlife habitat. However, site planning and design teams should use caution when siting a stormwater pond. They should use the results of the natural resources inventory (Section 6.3.3), to ensure that the pond will not negatively impact any existing primary conservation areas on the development site (e.g., freshwater wetlands, bottomland hardwood forests). Site planning and design teams should also consider the other potential drawbacks associated with stormwater ponds, including their potential to become a source of mosquitoes and harmful algal blooms.

There are several variations of stormwater ponds that can be used to manage post-construction stormwater runoff on development sites, the most common of which include wet ponds, wet extended detention ponds and micropool extended detention ponds (Figure 8.9). In addition, multiple stormwater ponds can be placed in series or parallel to increase storage capacity or address specific site characteristics or constraints (e.g., flat terrain). A brief description of each of these design variants is provided below:

- **Wet Ponds:** Wet ponds (Figure 8.10) are stormwater detention basins that are designed to have a permanent pool that provides enough storage for the stormwater runoff volume generated by the target runoff reduction rainfall event (e.g., 85th percentile rainfall event). Stormwater runoff is conveyed into the pool, where it is detained and treated over an extended period of time, primarily through gravitational settling and biological uptake, until it is displaced by stormwater runoff from the next rain event. Additional temporary storage (i.e., live storage) can be provided above the permanent pool for stormwater quantity control.
- **Wet Extended Detention (ED) Ponds:** Wet extended detention ponds (Figure 8.11) are wet ponds that are designed to have a permanent pool that provides enough storage for approximately 50% of the stormwater runoff volume generated by the target runoff

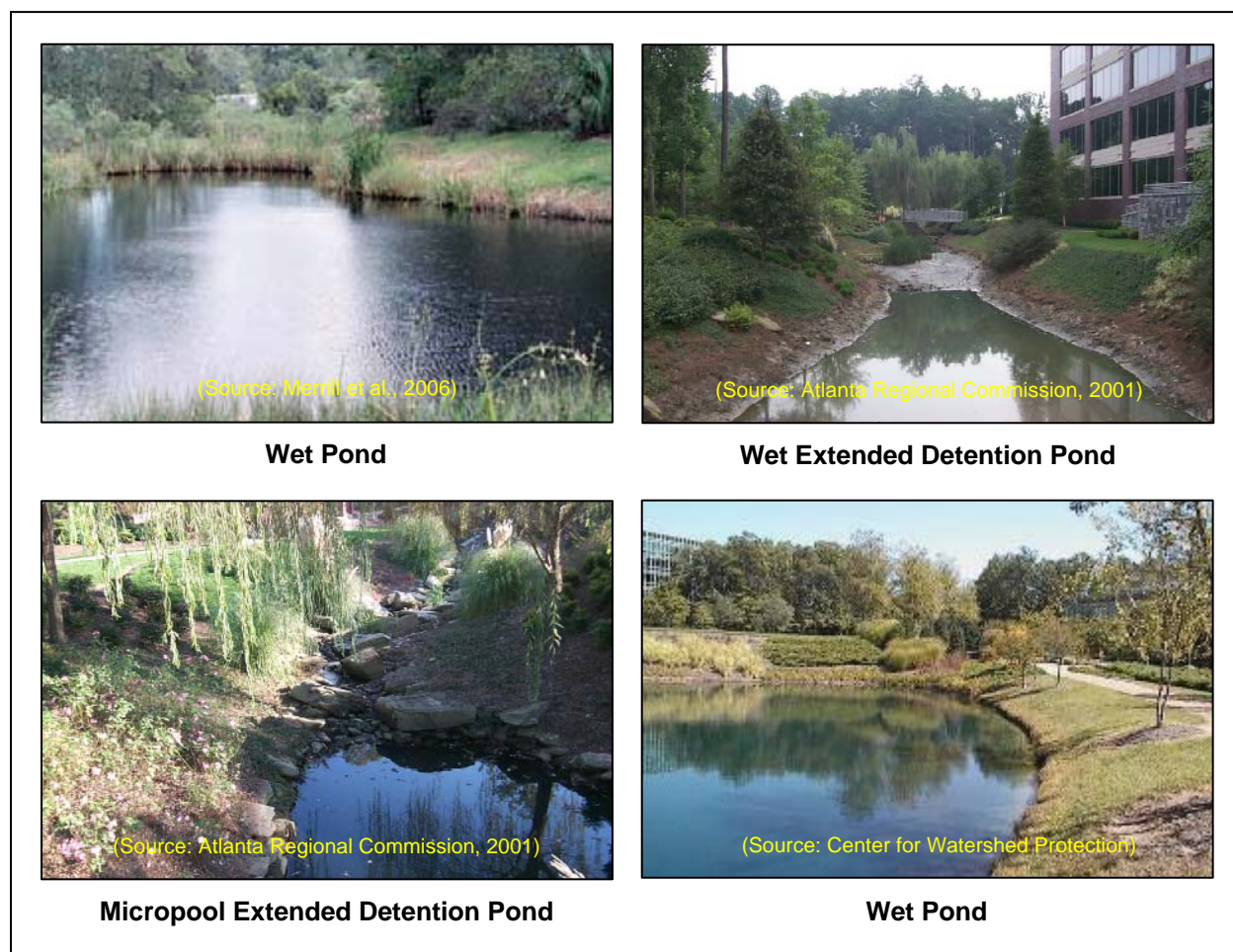

Figure 8.9: Various Stormwater Ponds

reduction rainfall event (e.g., 85th percentile rainfall event). The remainder of the stormwater runoff volume generated by the target runoff reduction rainfall event is managed in an extended detention zone provided immediately above the permanent pool. During wet weather, stormwater runoff is detained in the extended detention zone and released over a 24-hour period.

- **Micropool Extended Detention (ED) Ponds:** Micropool extended detention ponds (Figure 8.12) are a variation of the standard wet extended detention pond that have only a small permanent pool (i.e., micropool). The “micropool” provides enough storage for approximately 10% of the stormwater runoff volume generated by the target runoff reduction rainfall event (e.g., 85th percentile rainfall event). The remainder of the stormwater runoff volume generated by the target runoff reduction rainfall event is managed in an extended detention zone provided immediately above the “micropool” and released over an extended 24-hour period.
- **Multiple Pond Systems:** Multiple pond systems (Figure 8.13) consist of a series of two or more wet ponds, wet extended detention ponds or micropool extended detention ponds. The additional cells can increase the storage capacity provided on a development or redevelopment site.

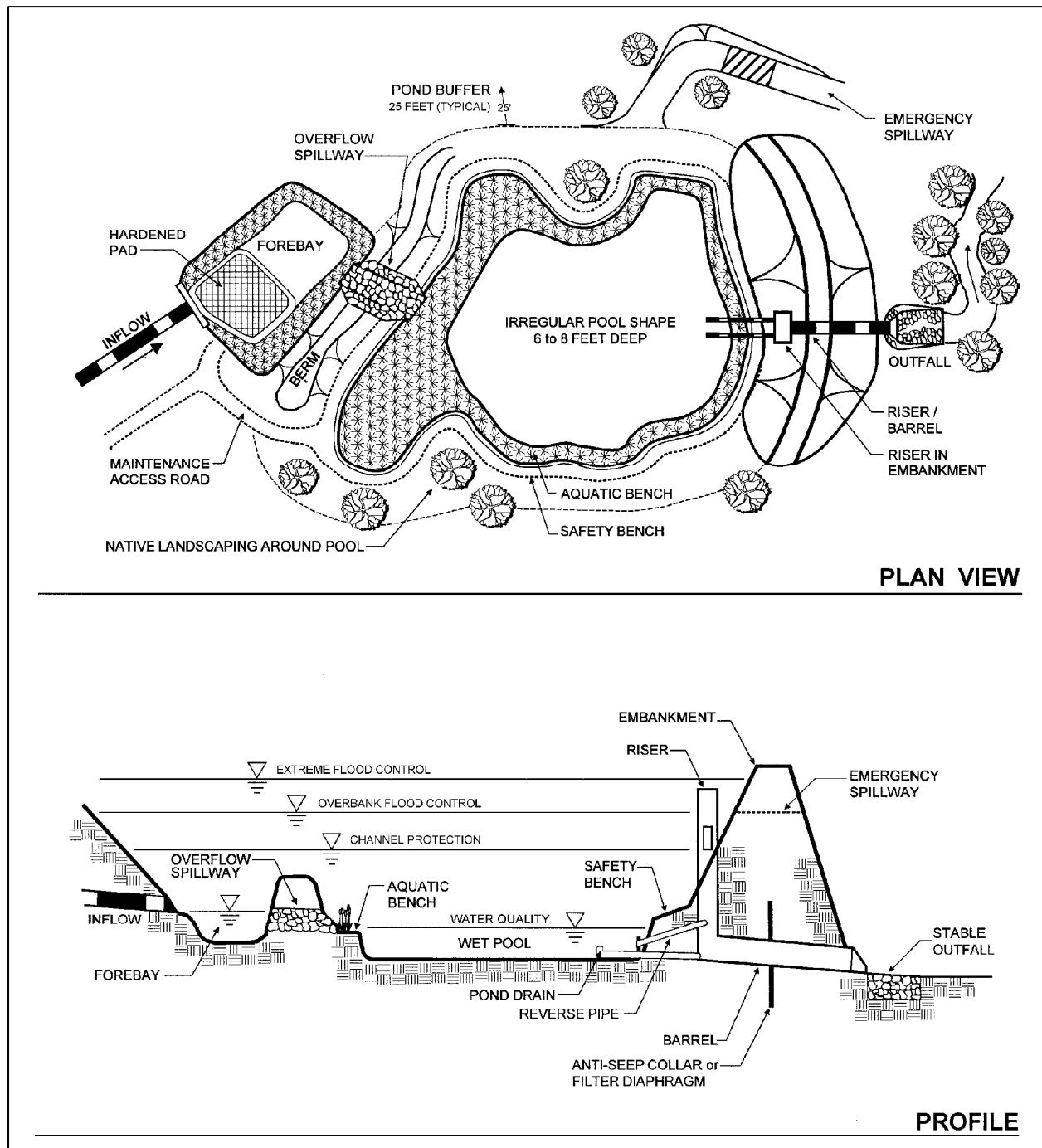

Figure 8.10: Schematic of a Typical Wet Pond
 (Source: Center for Watershed Protection)

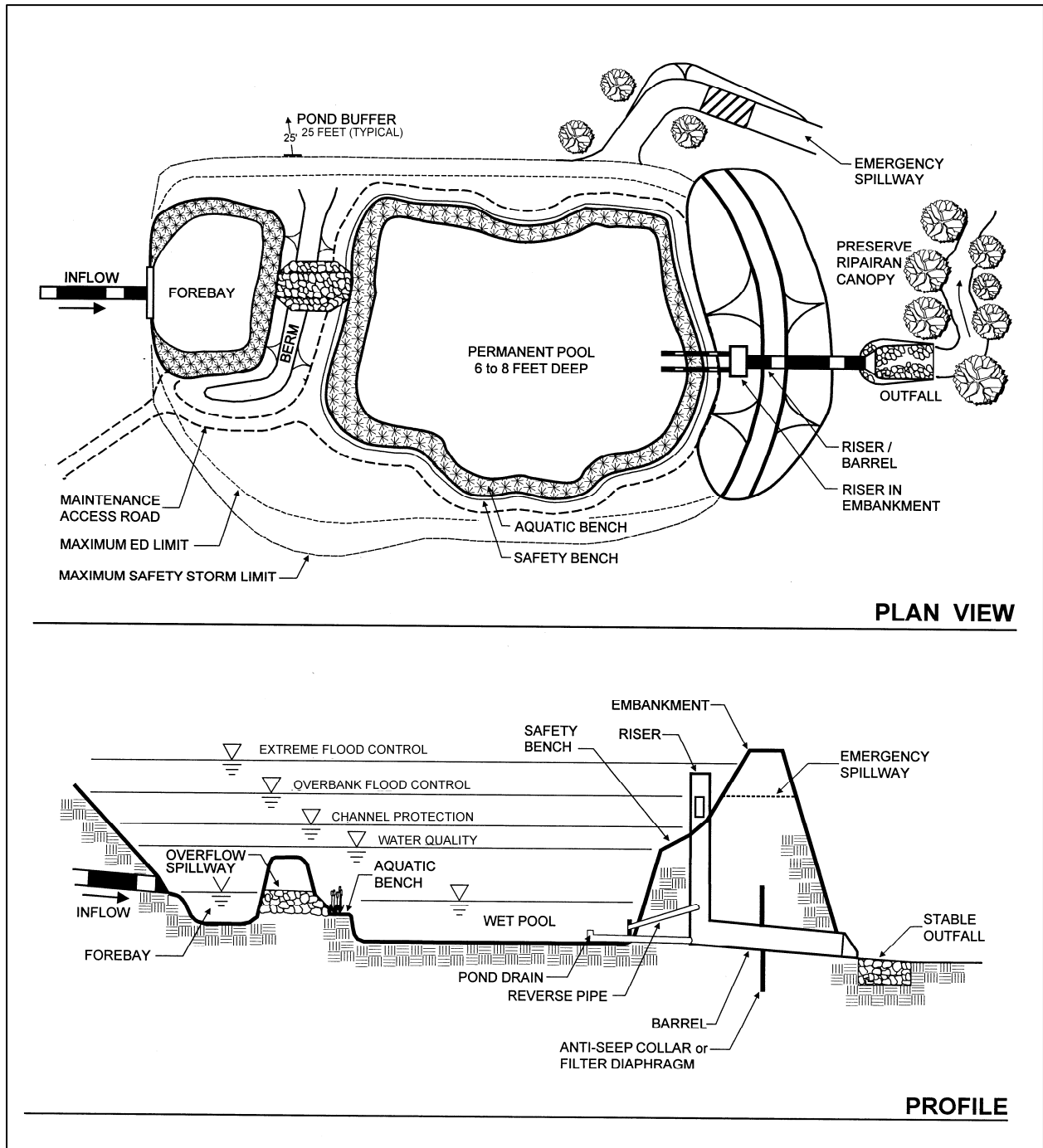

Figure 8.11: Schematic of a Typical Wet Extended Detention Pond
 (Source: Center for Watershed Protection)

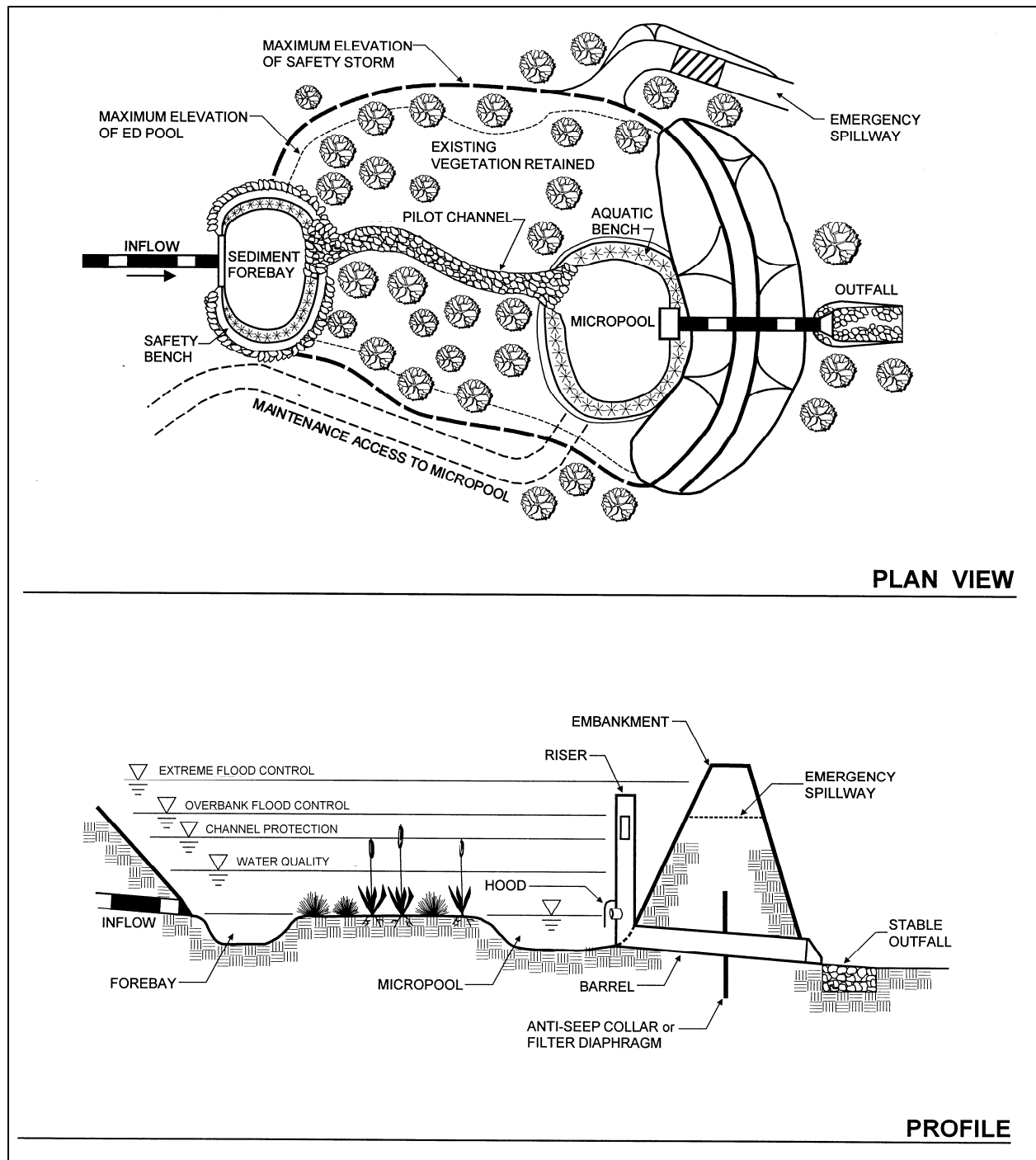

Figure 8.12: Schematic of a Typical Micropool Extended Detention Pond
 (Source: Center for Watershed Protection)

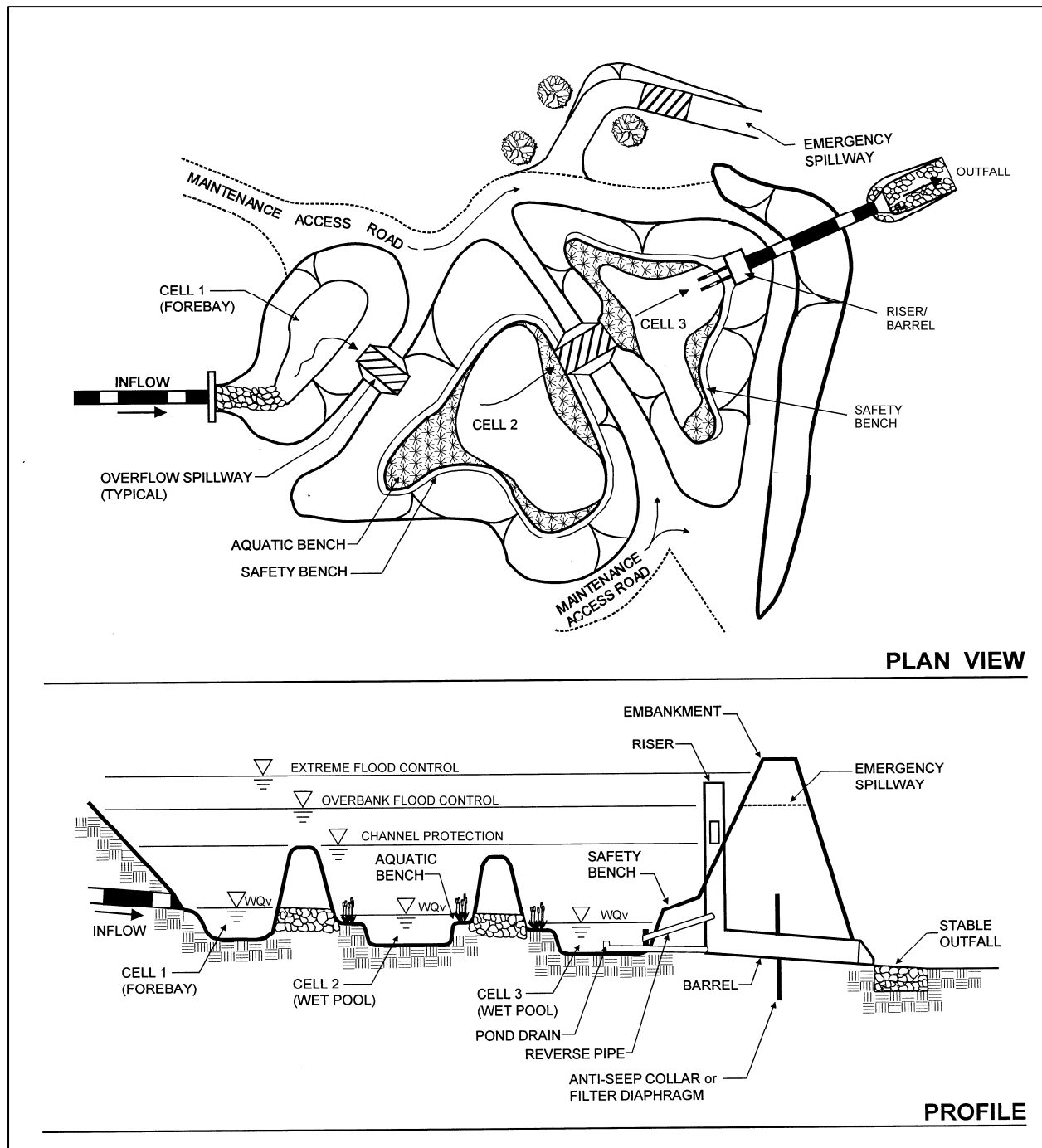

Figure 8.13: Schematic of a Typical Multiple Pond System
 (Source: Center for Watershed Protection)

Stormwater Management “Credits”

Stormwater ponds have been assigned quantifiable stormwater management “credits” that can be used to help satisfy the SWM Criteria presented in this CSS:

- Stormwater Runoff Reduction: None. Although stormwater ponds provide moderate to high removal of many of the pollutants of concern typically contained in post-construction stormwater runoff, recent research shows that they provide little, if any, reduction of post-construction stormwater runoff volumes (Hirschman et al., 2008, Strecker et al., 2004). Although stand-alone stormwater ponds cannot be used to help satisfy the stormwater runoff reduction criteria (SWM Criteria #1), stormwater ponds may be used as “cisterns” in large-scale rainwater harvesting systems (Section 7.8.12), which help reduce post-construction stormwater runoff volumes on a development site.
- Water Quality Protection: Assume that a *stormwater pond* provides an 80% reduction in TSS loads, a 30% reduction in TN loads and a 70% reduction in bacteria loads.
- Aquatic Resource Protection: A *stormwater pond* can be designed to provide 24-hours of extended detention for the aquatic resource protection volume (ARP_v).
- Overbank Flood Protection: A *stormwater pond* can be designed to attenuate the overbank peak discharge (Q_{p25}) on a development site.
- Extreme Flood Protection: A *stormwater pond* can be designed to attenuate the extreme peak discharge (Q_{p100}) on a development site.

In order to manage post-construction stormwater runoff and be eligible for these “credits,” it is *recommended* that stormwater ponds satisfy the planning and design criteria outlined below.

Overall Feasibility

The criteria listed in Table 8.4 should be evaluated to determine whether or not a stormwater pond is appropriate for use on a development site.

Table 8.4: Factors to Consider When Evaluating the Overall Feasibility Of Using a Stormwater Pond on a Development Site	
Site Characteristic	Criteria
Drainage Area	As a general rule of thumb, a contributing drainage area of 25 acres or more is typically needed to maintain a permanent pool in wet and wet extended detention ponds. A contributing drainage area of 10 acres or more is typically needed to maintain a permanent pool in micropool extended detention ponds. Water balance calculations should be completed to confirm that the contributing drainage area will be large enough or that there will be enough baseflow (e.g., groundwater) to maintain a permanent pool.
Area Required	In general, stormwater ponds require about 2-3% of the size of their contributing drainage areas.
Slope	Although stormwater ponds may be used on development sites with slopes of up to 15%, ponds constructed on development sites with steeper slopes typically require less excavation to create.
Minimum Head	6 to 8 feet

Table 8.4: Factors to Consider When Evaluating the Overall Feasibility Of Using a Stormwater Pond on a Development Site

Site Characteristic	Criteria
Minimum Depth to Water Table	No restrictions, although 2 feet of separation is recommended at stormwater hotspots and in areas known to provide groundwater recharge to water supply aquifers.
Soils	No restrictions, although poorly drained soils (i.e., hydrologic soil group C or D soils) are usually adequate to maintain a permanent pool in a stormwater pond. Stormwater ponds constructed on development sites with permeable soils (i.e., hydrologic soil group A or B soils) may require a pond liner.

Feasibility in Coastal Georgia

Several site characteristics commonly encountered in coastal Georgia may present challenges to site planning and design teams that are interested in using stormwater ponds to manage post-construction stormwater runoff on a development site. Table 8.5 identifies these common site characteristics and describes how they influence the use of stormwater ponds on development sites. The table also provides site planning and design teams with some ideas about how they can work around these potential constraints.

Table 8.5: Challenges Associated with Using Stormwater Ponds in Coastal Georgia

Site Characteristic	How it Influences the Use of Stormwater Ponds	Potential Solutions
<ul style="list-style-type: none"> <i>Poorly drained soils, such as hydrologic soil group C and D soils</i> 	<ul style="list-style-type: none"> Since they are designed to have a permanent pool of water, the presence of poorly drained soils does not influence the use of ponds on development sites. In fact, the presence of poorly drained soils may help maintain a permanent pool of water within a stormwater pond. 	
<ul style="list-style-type: none"> <i>Well drained soils, such as hydrologic soil group A and B soils</i> 	<ul style="list-style-type: none"> May be difficult to maintain a permanent pool of water within a stormwater pond. May allow stormwater pollutants to reach groundwater aquifers with greater ease. 	<ul style="list-style-type: none"> Install a pond liner to maintain a permanent pool of water. At stormwater hotspots and in areas known to provide groundwater recharge to water supply aquifers, install a pond liner to prevent pollutants from reaching groundwater aquifers. In areas that are not considered to be stormwater hotspots and areas that do not provide groundwater recharge to water supply aquifers, use non-underdrained bioretention areas (Section 8.6.3) and infiltration practices (Section 8.6.5) to significantly reduce stormwater runoff rates, volumes and pollutant loads.

Table 8.5: Challenges Associated with Using Stormwater Ponds in Coastal Georgia		
Site Characteristic	How it Influences the Use of Stormwater Ponds	Potential Solutions
<ul style="list-style-type: none"> <i>Flat terrain</i> 	<ul style="list-style-type: none"> Reduces the amount of storage volume that can be provided within a stormwater pond. Makes it difficult, if not impossible, to provide a pond drain at the bottom of a stormwater pond. 	<ul style="list-style-type: none"> Design stormwater ponds that have shallower permanent pools, with depths of 4 feet or less (e.g., dugouts). Eliminate the use of pond drains, if necessary. Consider stormwater wetlands (Section 8.6.2) as an alternative stormwater management practice in areas with flat terrain and a shallow water table.
<ul style="list-style-type: none"> <i>Shallow water table</i> 	<ul style="list-style-type: none"> Makes it easier to maintain a permanent pool within a stormwater pond, but may allow stormwater pollutants to reach groundwater aquifers with greater ease. 	<ul style="list-style-type: none"> Excavation below the water table to create a stormwater pond is acceptable, but any storage volume found below the water table should not be counted when determining the total storage volume provided by the stormwater pond. At stormwater hotspots and in areas known to provide groundwater recharge to water supply aquifers, install a pond liner to prevent pollutants from reaching underlying groundwater aquifers. Use bioretention areas (Section 8.6.3) and filtration practices (Section 8.6.4) with liners and underdrains to intercept and treat stormwater runoff at stormwater hotspots and in areas known to provide groundwater recharge to water supply aquifers.

Table 8.5: Challenges Associated with Using Stormwater Ponds in Coastal Georgia		
Site Characteristic	How it Influences the Use of Stormwater Ponds	Potential Solutions
<ul style="list-style-type: none"> <i>Tidally-influenced drainage system</i> 	<ul style="list-style-type: none"> May occasionally prevent stormwater runoff from being conveyed through a stormwater pond, particularly during high tide. May increase the amount of pollution that is transferred from stormwater ponds to adjacent estuarine resources. 	<ul style="list-style-type: none"> Maximize the use of low impact development practices (Section 7.8) in these areas to reduce stormwater runoff rates, volumes and pollutant loads. Provide enlarged aquatic benches (e.g., up to 30 feet wide) that have been planted with dense wetland vegetation to increase pollutant removal. Consider the use of bubbler aeration and proper fish stocking to maintain nutrient cycling and healthy oxygen levels in stormwater ponds located in these areas. Consider stormwater wetlands (Section 8.6.2) as an alternative stormwater management practice in these areas.

Site Applicability

Although it may be difficult to use them to manage post-construction stormwater runoff in urban areas, due to space constraints, stormwater ponds can be used to manage stormwater runoff on a wide variety of development sites, including residential, commercial, industrial and institutional development sites in rural and suburban areas. When compared with other stormwater management practices, stormwater ponds have a relatively low construction cost, a relatively low maintenance burden and require a relatively large amount of surface area.

Planning and Design Criteria

It is *recommended* that stormwater ponds meet all of the planning and design criteria provided in Section 3.2.1 of Volume 2 of the *Georgia Stormwater Management Manual* (ARC, 2001) to be eligible for the stormwater management "credits" described above.

Construction Considerations

To help ensure that stormwater ponds are successfully installed on a development site, site planning and design teams should consider the following recommendations:

- Because stormwater ponds are typically installed early in the construction phase, they may accumulate a significant amount of sediment during construction. Any accumulated sediment should be removed from stormwater ponds near the end of the construction phase.
- To help prevent excessive sediment accumulation, stormwater runoff may be diverted around the stormwater pond until the contributing drainage area has become stabilized.
- Sediment markers should be installed in forebays and permanent pools to help determine when sediment removal is needed.

Maintenance Requirements

Maintenance is very important for stormwater ponds, particularly in terms of ensuring that they continue to provide measurable stormwater management benefits over time. Consequently, a legally binding inspection and maintenance agreement and plan should be created to help ensure that they are properly maintained after construction is complete. Table 8.6 provides a list of the routine maintenance activities typically associated with stormwater ponds.

Activity	Schedule
<ul style="list-style-type: none"> Water side slopes and buffers to promote plant growth and survival. Inspect side slopes and buffers following rainfall events. Plant replacement vegetation in any eroded areas. 	As Needed (Following Construction)
<ul style="list-style-type: none"> Remove any accumulated sediment and debris from inlet and outlet structures. 	Monthly
<ul style="list-style-type: none"> Inspect side slopes and buffers for erosion. Plant replacement vegetation in any eroded areas. Inspect side slopes and buffers for dead or dying vegetation. Plant replacement vegetation as needed. Inspect side slopes and buffers for invasive vegetation and remove as needed. If applicable, monitor wetland vegetation and perform replacement planting as necessary. 	Annually (Semi-Annually During First Year)
<ul style="list-style-type: none"> Inspect for damage, paying particular attention to the control structure and side slopes. Repair as necessary. Inspect side slopes for erosion and undercutting and repair as needed. Check for signs of eutrophic conditions (e.g., excessive algal growth). Check for signs of hydrocarbon accumulation and remove appropriately. Monitor sediment markers for sediment accumulation in forebays and permanent pools. Examine to ensure that inlet and outlet devices are free of sediment and debris and are operational. Check all control gates, valves and other mechanical devices. 	Annually
<ul style="list-style-type: none"> Remove sediment from forebay. 	5 to 7 years or after 50% of the total forebay storage capacity has been lost
<ul style="list-style-type: none"> Monitor sediment markers for sediment accumulation and remove sediment when the permanent pool volume has become reduced significantly, or when the pond becomes eutrophic. 	10 to 20 years or after 25% of the permanent pool volume has been lost

It should be noted that sediments excavated from stormwater ponds that do not receive stormwater runoff from stormwater hotspots are typically not considered to be toxic and can be safely disposed through either land application or landfilling. Check with the local development review authority to identify any additional constraints on the disposal of sediments excavated from stormwater ponds.

Additional Resources

Atlanta Regional Commission (ARC). 2001. "Stormwater Ponds." *Georgia Stormwater Management Manual*. Volume 2. Technical Handbook. Section 3.2.1. Atlanta Regional Commission. Atlanta, GA. Available Online: <http://www.georgia-stormwater.com/>.

Minnesota Pollution Control Agency (MPCA). 2006. "Stormwater Ponds." *Minnesota Stormwater Manual*. Chapter 12. Minnesota Pollution Control Agency. Available Online: <http://www.pca.state.mn.us/water/stormwater/stormwater-manual.html>.

THIS PAGE INTENTIONALLY LEFT BLANK

8.6.2 Stormwater Wetlands

Description

Stormwater wetlands are constructed wetland systems built for stormwater management purposes. They typically consist of a combination of open water, shallow marsh and semi-wet areas that are located just above the permanent water surface. As stormwater runoff flows through a wetland, it is treated, primarily through gravitational settling and biological uptake. Temporary storage (i.e., live storage) can be provided above the permanent water surface for stormwater quantity control. This allows wetlands to both *treat* stormwater runoff and *manage* the stormwater runoff rates and volumes generated by larger rainfall events.



(Source: Merrill et al., 2006)

<p style="text-align: center;"><u>KEY CONSIDERATIONS</u></p> <p>DESIGN CRITERIA:</p> <ul style="list-style-type: none"> • Contributing drainage area of 25 acres or more typically needed for shallow and shallow extended detention wetlands; 10 acres or more typically needed for pocket wetlands • A sediment forebay (or equivalent pretreatment) should be provided upstream of all wetlands • Minimum of 35% of wetland surface area should have a depth of 6 inches or less; 10% to 20% of surface area should have a depth of between 1.5 and 6 feet • Length to width ratio should be at least 2:1 (L:W), although a length to width ratio of 3:1 (L:W) or greater is preferred • Side slopes should not exceed 3:1 (H:V) <p>BENEFITS:</p> <ul style="list-style-type: none"> • Provides moderate to high removal of many of the pollutants of concern typically contained in post-construction stormwater runoff • Ideal for use in flat terrain and in areas with high groundwater <p>LIMITATIONS:</p> <ul style="list-style-type: none"> • Provides minimal reduction of post-construction stormwater runoff volumes • Requires relatively large amount of land 	<p style="text-align: center;"><u>STORMWATER MANAGEMENT "CREDITS"</u></p> <p>Runoff Reduction</p> <ul style="list-style-type: none"> <input checked="" type="checkbox"/> Water Quality Protection <input checked="" type="checkbox"/> Aquatic Resource Protection <input checked="" type="checkbox"/> Overbank Flood Protection <input checked="" type="checkbox"/> Extreme Flood Protection <p><input checked="" type="checkbox"/> = practice has been assigned quantifiable stormwater management "credits" that can be used to address this SWM Criteria</p>						
<p style="text-align: center;"><u>SITE APPLICABILITY</u></p> <table border="0"> <tr> <td><input checked="" type="checkbox"/> Rural Use</td> <td><input type="checkbox"/> L Construction Cost</td> </tr> <tr> <td><input checked="" type="checkbox"/> Suburban Use</td> <td><input type="checkbox"/> M Maintenance</td> </tr> <tr> <td>Urban Use</td> <td><input type="checkbox"/> H Area Required</td> </tr> </table>	<input checked="" type="checkbox"/> Rural Use	<input type="checkbox"/> L Construction Cost	<input checked="" type="checkbox"/> Suburban Use	<input type="checkbox"/> M Maintenance	Urban Use	<input type="checkbox"/> H Area Required	<p style="text-align: center;"><u>STORMWATER MANAGEMENT PRACTICE PERFORMANCE</u></p> <p>Runoff Reduction 0% - Annual Runoff Volume 0% - Runoff Reduction Volume</p> <p>Pollutant Removal¹ 80% - Total Suspended Solids 50% - Total Phosphorus 30% - Total Nitrogen 50% - Metals 70% - Pathogens</p> <p>1 = expected annual pollutant load removal</p>
<input checked="" type="checkbox"/> Rural Use	<input type="checkbox"/> L Construction Cost						
<input checked="" type="checkbox"/> Suburban Use	<input type="checkbox"/> M Maintenance						
Urban Use	<input type="checkbox"/> H Area Required						

Discussion

Stormwater wetlands (also known as *constructed wetlands*) are constructed wetland systems built for stormwater management purposes. They typically consist of a combination of open water, shallow marsh and semi-wet areas that are located just above the permanent water surface. As stormwater runoff flows through a wetland, it is treated, primarily through gravitational settling and biological uptake. Temporary storage (i.e., live storage) can be provided above the permanent water surface for stormwater quantity control. This allows wetlands to both *treat* stormwater runoff and *manage* the stormwater runoff rates and volumes generated by larger rainfall events.

Stormwater wetlands treat post-construction stormwater runoff through a combination of physical, chemical and biological processes. The primary pollutant removal mechanisms at work in stormwater wetlands are biological uptake, physical screening and gravitational settling. Other pollutant removal mechanisms at work in stormwater wetlands include volatilization and other biological and chemical processes.

Stormwater wetlands are among the most effective stormwater management practices that can be used coastal Georgia and the rest of the United States. They are typically created by excavating a depressional area to create "dead storage" below the water surface elevation of the receiving storm drain system, stream or other aquatic resource. A well-designed stormwater wetland can be attractively integrated into a development site as a landscaping feature and, if appropriately designed, sited and landscaped, can provide valuable wildlife habitat. Stormwater wetlands differ from natural wetland systems in that they are engineered facilities designed specifically for the purpose of managing post-construction stormwater runoff. They typically have less biodiversity than natural wetlands in terms of both plant and animal life but, like natural wetlands, require continuous base flow or a high water table to maintain a permanent water surface and support the growth of aquatic vegetation.

There are several variations of stormwater wetlands that can be used to manage post-construction stormwater runoff on development sites, including shallow wetlands, shallow extended detention wetlands and pocket wetlands. In addition, stormwater wetlands can be used in combination with stormwater ponds to increase storage capacity or address specific site characteristics or constraints (e.g., flat terrain). A brief description of each of these design variants is provided below:

- **Shallow Wetlands:** In a shallow wetland (Figure 8.15), most of the storage volume provided by the wetland is contained in some relatively shallow high marsh and low marsh areas. The only deep water areas found within a shallow wetland are the forebay, which is located at the entrance to the wetland, and the "micropool," which is located at the outlet. One disadvantage to the shallow wetland design is that, since most of the storage volume is provided in the relatively shallow high marsh and low marsh areas, a large amount of land may be needed to provide enough storage for the stormwater runoff volume generated by the target runoff reduction rainfall event (e.g., 85th percentile rainfall event).
- **Shallow Extended Detention (ED) Wetlands:** A shallow extended detention wetland (Figure 8.16) is essentially the same as a shallow wetland, except that approximately 50% of the stormwater runoff volume generated by the target runoff reduction rainfall event (e.g., 85th percentile rainfall event) is managed in an extended detention zone provided immediately above the permanent water surface. During wet weather, stormwater runoff is detained in the extended detention zone and released over a 24-hour period. Although this design variant requires less land than the shallow wetland design variant, it

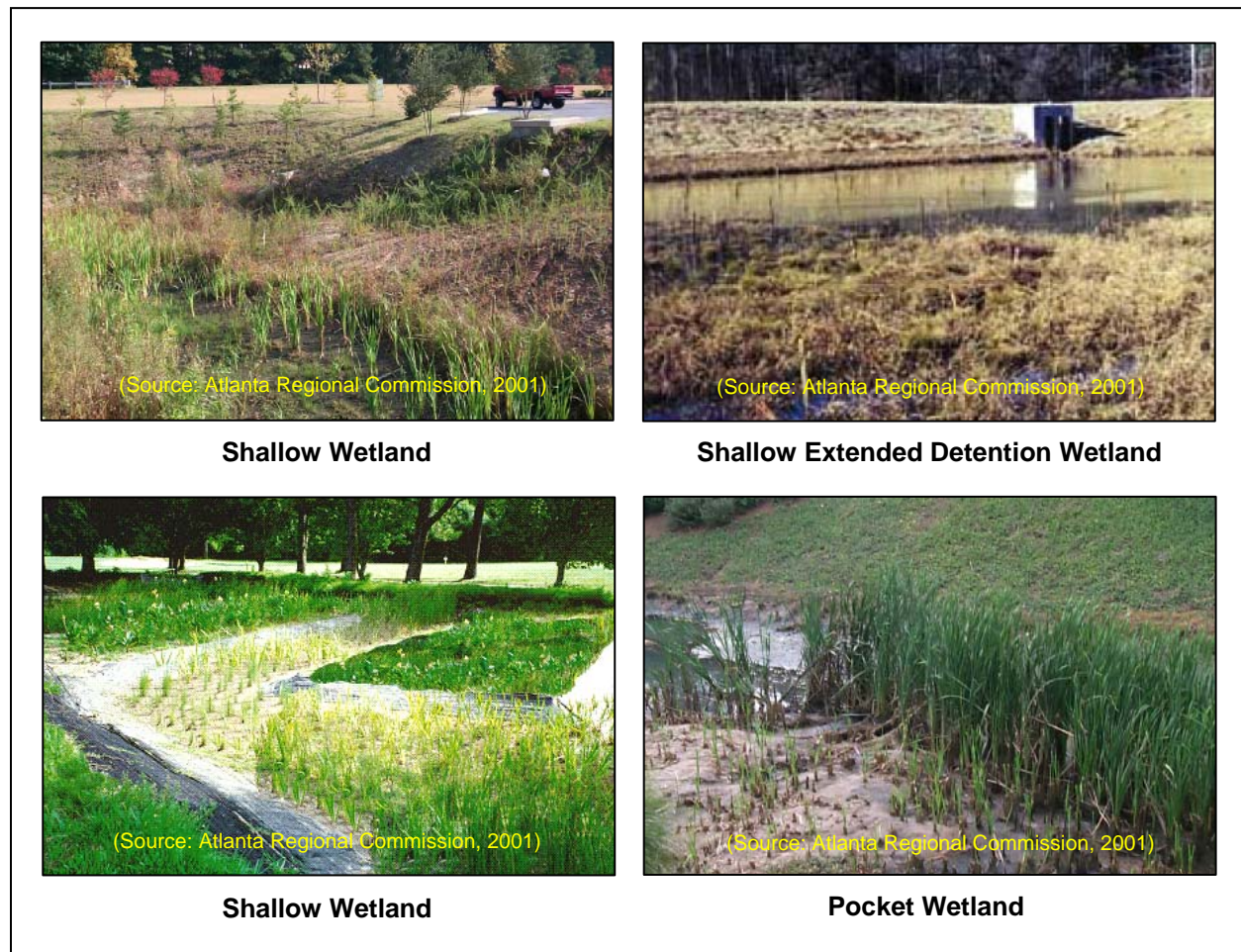

Figure 8.14: Various Stormwater Wetlands

can be difficult to establish vegetation within the extended detention zone due to the fluctuating water surface elevations found within.

- **Pond/Wetland Systems:** A pond/wetland system (Figure 8.17) has two separate cells, one of which is a wet pond and the other of which is a shallow wetland. The wet pond cell is used to trap sediment and reduce stormwater runoff velocities upstream of the shallow wetland cell. Less land is typically required for pond/wetland systems than for shallow wetlands or shallow extended detention wetlands.
- **Pocket Wetlands:** Pocket wetlands (Figure 8.18) can be used to intercept and manage stormwater runoff from relatively small drainage areas of up to about 10 acres in size. In order to ensure that they have a permanent water surface throughout the year, they are typically designed to interact with the groundwater table.

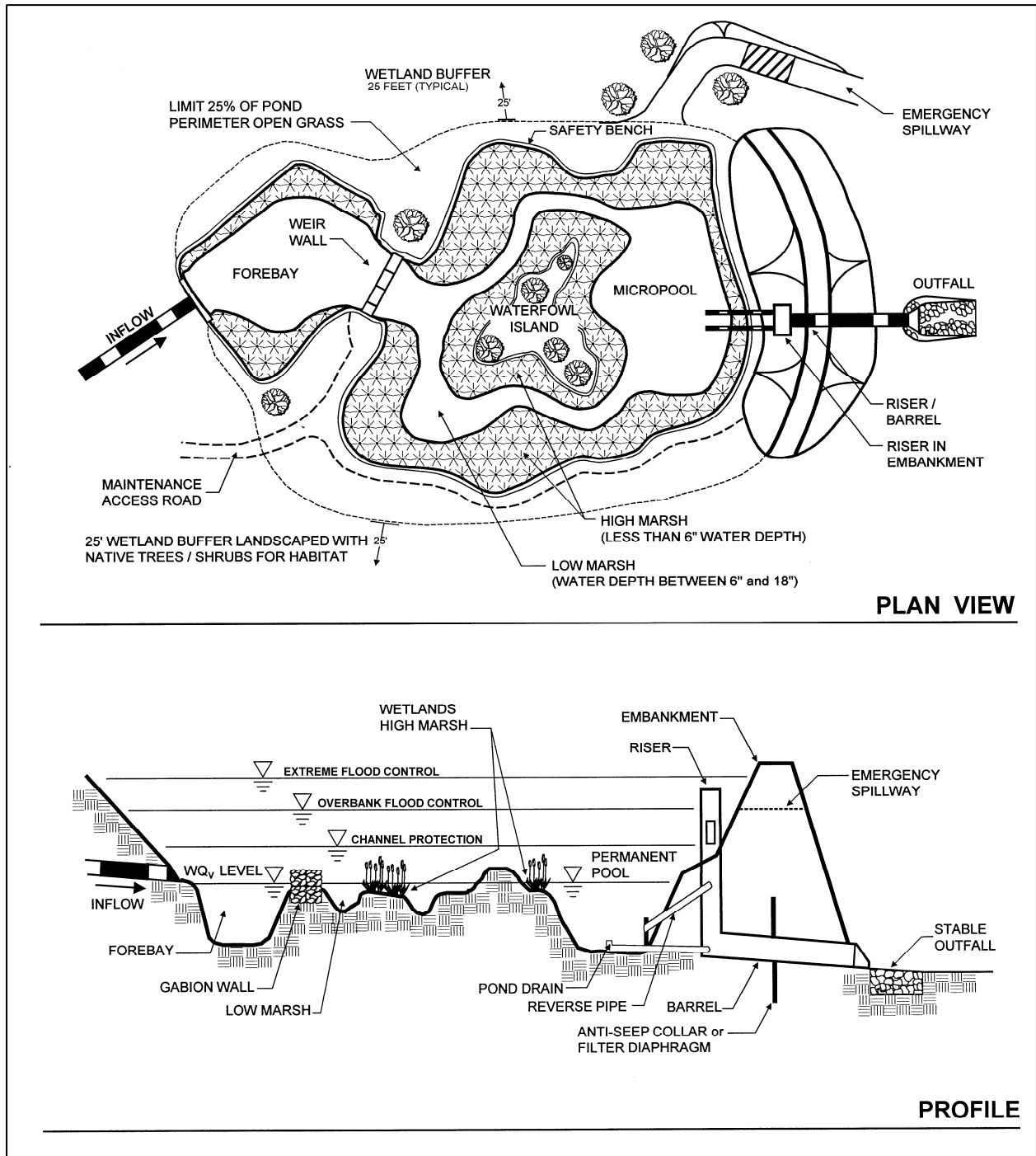

Figure 8.15: Schematic of a Typical Shallow Wetland
 (Source: Center for Watershed Protection)

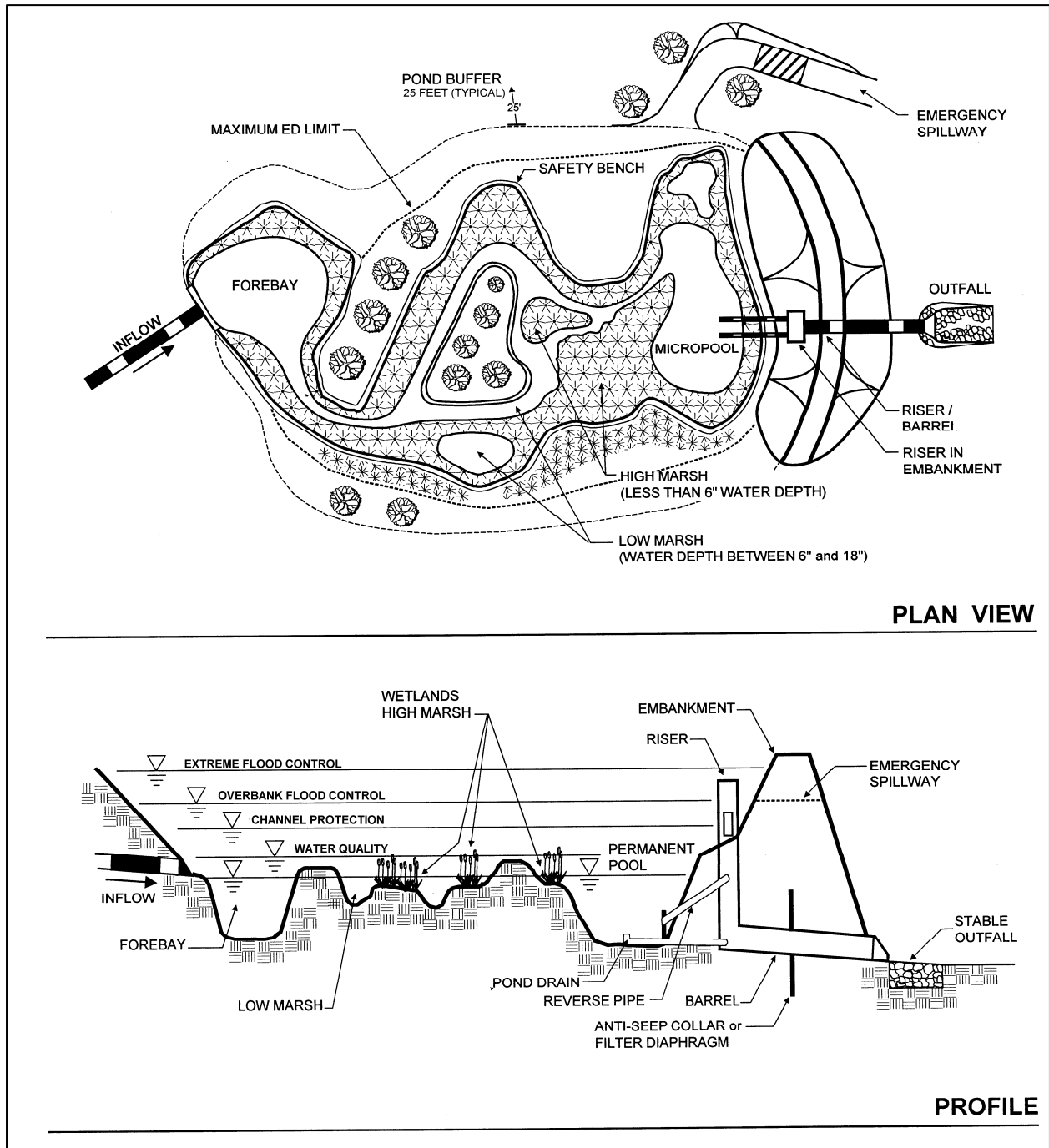

Figure 8.16: Schematic of a Typical Shallow Extended Detention Wetland
 (Source: Center for Watershed Protection)

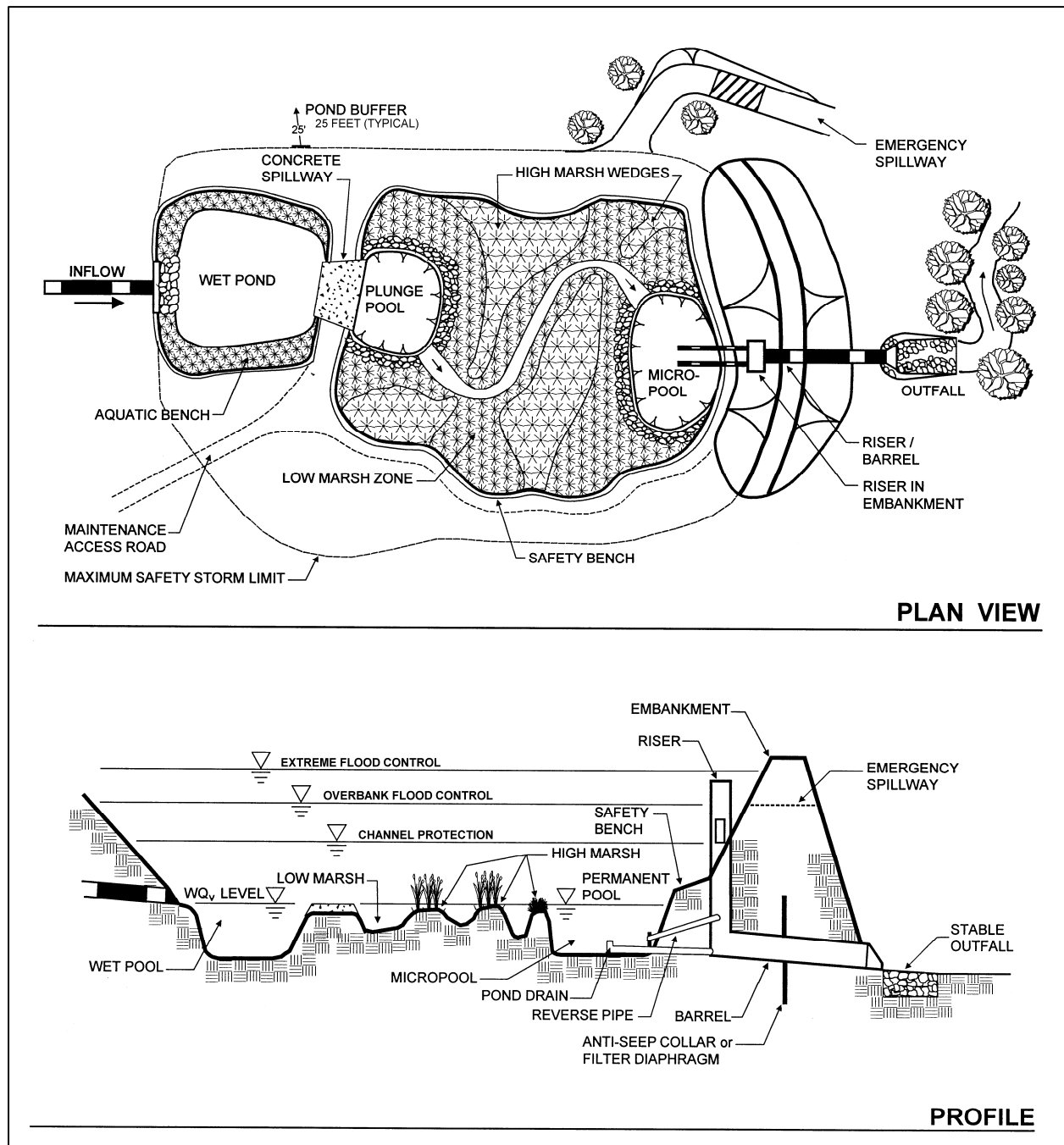

Figure 8.17: Schematic of a Typical Pond/Wetland System
 (Source: Center for Watershed Protection)

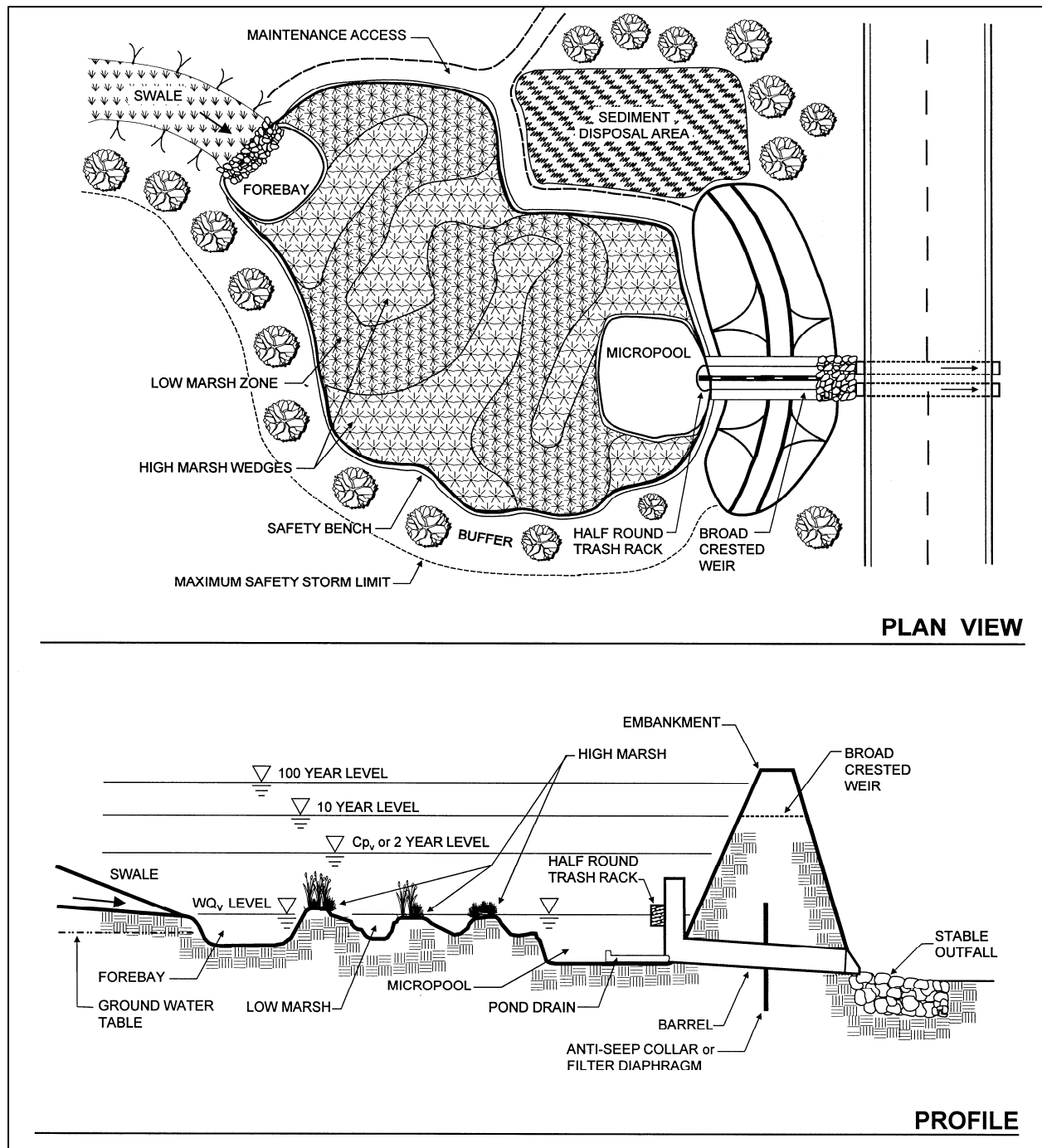

Figure 8.18: Schematic of a Typical Pocket Wetland
 (Source: Center for Watershed Protection)

Stormwater Management “Credits”

Stormwater wetlands have been assigned quantifiable stormwater management “credits” that can be used to help satisfy the SWM Criteria presented in this CSS:

- Stormwater Runoff Reduction: None. Although stormwater wetlands provide moderate to high removal of many of the pollutants of concern typically contained in post-construction stormwater runoff, recent research shows that they provide little, if any, reduction of post-construction stormwater runoff volumes (Hirschman et al., 2008, Strecker et al., 2004).
- Water Quality Protection: Assume that a *stormwater wetland* provides an 80% reduction in TSS loads, a 30% reduction in TN loads and an 80% reduction in bacteria loads.
- Aquatic Resource Protection: A *stormwater wetland* can be designed to provide 24-hours of extended detention for the aquatic resource protection volume (ARP_v). Site planning and design teams are encouraged to store this volume in as shallow an area as possible to minimize the magnitude of the water surface elevation fluctuations that take place within the wetland.
- Overbank Flood Protection: A *stormwater wetland* can be designed to attenuate the overbank peak discharge (Q_{p25}) on a development site.
- Extreme Flood Protection: A *stormwater wetland* can be designed to attenuate the extreme peak discharge (Q_{p100}) on a development site.

In order to manage post-construction stormwater runoff and be eligible for these “credits,” it is *recommended* that stormwater wetlands satisfy the planning and design criteria outlined below.

Overall Feasibility

The criteria listed in Table 8.7 should be evaluated to determine whether or not a stormwater wetland is appropriate for use on a development site.

Table 8.7: Factors to Consider When Evaluating the Overall Feasibility Of Using a Stormwater Wetland on a Development Site	
Site Characteristic	Criteria
Drainage Area	As a general rule of thumb, a contributing drainage area of 25 acres or more is typically needed to maintain a permanent water surface in shallow wetlands, shallow ED wetlands and pond/wetland systems. A contributing drainage area of 5 acres or more is typically needed to maintain a permanent water surface in pocket wetlands. Water balance calculations should be completed to confirm that the contributing drainage area will be large enough or that there will be enough baseflow (e.g., groundwater) to maintain a permanent water surface.
Area Required	In general, stormwater wetlands require about 3-5% of the size of their contributing drainage areas.
Slope	Although stormwater wetlands may be used on development sites with slopes of up to 15%, wetlands constructed on development sites with steeper slopes typically require less excavation to create.
Minimum Head	2 to 5 feet

Table 8.7: Factors to Consider When Evaluating the Overall Feasibility Of Using a Stormwater Wetland on a Development Site

Site Characteristic	Criteria
Minimum Depth to Water Table	No restrictions, although 2 feet of separation is recommended at stormwater hotspots and in areas known to provide groundwater recharge to water supply aquifers.
Soils	No restrictions, although poorly drained soils (i.e., hydrologic soil group C or D soils) are usually adequate to maintain a permanent water surface in a stormwater wetland. Stormwater wetlands constructed on development sites with permeable soils (i.e., hydrologic soil group A or B soils) may require a liner.

Feasibility in Coastal Georgia

Several site characteristics commonly encountered in coastal Georgia may present challenges to site planning and design teams that are interested in using stormwater wetlands to manage post-construction stormwater runoff on a development site. Table 8.8 identifies these common site characteristics and describes how they influence the use of stormwater wetlands on development sites. The table also provides site planning and design teams with some ideas about how they can work around these potential constraints.

Table 8.8: Challenges Associated with Using Stormwater Wetlands in Coastal Georgia

Site Characteristic	How it Influences the Use of Stormwater Wetlands	Potential Solutions
<ul style="list-style-type: none"> <i>Poorly drained soils, such as hydrologic soil group C and D soils</i> 	<ul style="list-style-type: none"> Since they are designed to have a permanent water surface, the presence of poorly drained soils does not influence the use of stormwater wetlands on development sites. In fact, the presence of poorly drained soils may help maintain a permanent water surface within a stormwater wetland. 	
<ul style="list-style-type: none"> <i>Well drained soils, such as hydrologic soil group A and B soils</i> 	<ul style="list-style-type: none"> May be difficult to maintain a permanent water surface within a stormwater wetland. May allow stormwater pollutants to reach groundwater aquifers with greater ease. 	<ul style="list-style-type: none"> Install a liner to maintain a permanent water surface. At stormwater hotspots and in areas known to provide groundwater recharge to water supply aquifers, install a liner to prevent pollutants from reaching underlying groundwater aquifers. In areas that are not considered to be stormwater hotspots and areas that do not provide groundwater recharge to water supply aquifers, use non-underdrained bioretention areas (Section 8.6.3) and infiltration practices (Section 8.6.5) to significantly reduce stormwater runoff volumes.

Table 8.8: Challenges Associated with Using Stormwater Wetlands in Coastal Georgia		
Site Characteristic	How it Influences the Use of Stormwater Wetlands	Potential Solutions
<ul style="list-style-type: none"> • <i>Flat terrain</i> 	<ul style="list-style-type: none"> • Makes it difficult, if not impossible, to provide a drain at the bottom of a stormwater wetland. 	<ul style="list-style-type: none"> • Eliminate the use of drains, if necessary.
<ul style="list-style-type: none"> • <i>Shallow water table</i> 	<ul style="list-style-type: none"> • Makes it easier to maintain a permanent water surface within a stormwater wetland, but may allow stormwater pollutants to reach groundwater aquifers with greater ease. 	<ul style="list-style-type: none"> • Excavation below the water table to create a stormwater wetland is acceptable, but any storage volume found below the water table should not be counted when determining the total storage volume provided by the stormwater wetland. • At stormwater hotspots and in areas known to provide groundwater recharge to water supply aquifers, install a liner to prevent pollutants from reaching underlying groundwater aquifers. • Use bioretention areas (Section 8.6.3) and filtration practices (Section 8.6.4) with liners and underdrains to intercept and treat stormwater runoff at stormwater hotspots and in areas known to provide groundwater recharge to water supply aquifers.
<ul style="list-style-type: none"> • <i>Tidally-influenced drainage system</i> 	<ul style="list-style-type: none"> • May occasionally prevent stormwater runoff from being conveyed through a stormwater wetland, particularly during high tide. 	<ul style="list-style-type: none"> • Maximize the use of low impact development practices (Section 7.8) in these areas to reduce stormwater runoff rates, volumes and pollutant loads. • Consider the use of bubbler aeration and proper fish stocking to maintain nutrient cycling and healthy oxygen levels in stormwater wetlands located in these areas.

Site Applicability

Although it may be difficult to use them to manage post-construction stormwater runoff in urban areas, due to space constraints, stormwater wetlands can be used to manage stormwater runoff on a wide variety of development sites, including residential, commercial, industrial and institutional development sites in rural and suburban areas. When compared with other stormwater management practices, stormwater wetlands have a relatively low construction cost, a moderate maintenance burden and require a relatively large amount of surface area.

Planning and Design Criteria

It is *recommended* that stormwater wetlands meet all of the planning and design criteria provided in Section 3.2.2 of Volume 2 of the *Georgia Stormwater Management Manual* (ARC, 2001) to be eligible for the stormwater management “credits” described above.

Construction Considerations

To help ensure that stormwater wetlands are successfully installed on a development site, site planning and design teams should consider the following recommendations:

- While the earthwork for a stormwater wetland can be completed early in the construction phase, stormwater wetlands should not be landscaped until the end of the construction phase, when the contributing drainage area has been stabilized.
- Because stormwater wetlands are typically installed early in the construction phase, they may accumulate a significant amount of sediment during construction. Any accumulated sediment should be removed from stormwater wetlands near the end of the construction phase.
- To help prevent excessive sediment accumulation, stormwater runoff may be diverted around the stormwater wetland until the contributing drainage area has become stabilized.
- Sediment markers should be installed in forebays and permanent pools to help determine when sediment removal is needed.

Maintenance Requirements

Maintenance is very important for stormwater wetlands, particularly in terms of ensuring that they continue to provide measurable stormwater management benefits over time. Consequently, a legally binding inspection and maintenance agreement and plan should be created to help ensure that they are properly maintained after construction is complete. Table 8.9 provides a list of the routine maintenance activities typically associated with stormwater wetlands.

Activity	Schedule
<ul style="list-style-type: none"> • Water side slopes and buffers to promote plant growth and survival. • Inspect wetland, side slopes and buffers following rainfall events. Plant replacement vegetation in any eroded areas. 	As Needed (Following Construction)
<ul style="list-style-type: none"> • Remove any accumulated sediment and debris from inlet and outlet structures. 	Monthly
<ul style="list-style-type: none"> • Inspect wetland, side slopes and buffers for erosion. Plant replacement vegetation in any eroded areas. • Inspect wetland, side slopes and buffers for dead or dying vegetation. Plant replacement vegetation as needed. • Inspect wetland, side slopes and buffers for invasive vegetation and remove as needed. • Monitor wetland vegetation and perform replacement planting as necessary. • Harvest wetland plants that have been “choked out” by sediment build-up. 	Semi-Annually (Quarterly During First Year)

Table 8.9: Routine Maintenance Activities Typically Associated with Stormwater Wetlands	
Activity	Schedule
<ul style="list-style-type: none"> Inspect wetland vegetation and replace vegetation, as necessary, to maintain at least 75% surface area coverage after the end of the first growing season. 	One-Time Activity
<ul style="list-style-type: none"> Inspect for damage, paying particular attention to the control structure and side slopes. Repair as necessary. Examine stability of the original depth zones and microtopographical features. Inspect side slopes for erosion and undercutting and repair as needed. Check for signs of eutrophic conditions (e.g., excessive algal growth). Check for signs of hydrocarbon accumulation and remove appropriately. Monitor sediment markers for sediment accumulation in forebays and permanent pools. Examine to ensure that inlet and outlet devices are free of sediment and debris and are operational. Check all control gates, valves and other mechanical devices. 	Annually
<ul style="list-style-type: none"> Remove sediment from forebay. 	5 to 7 years or after 50% of the total forebay storage capacity has been lost
<ul style="list-style-type: none"> Monitor sediment markers for sediment accumulation and remove sediment when the permanent pool volume has become reduced significantly, plants are "choked" with sediment, or the wetland becomes eutrophic. 	10 to 20 years or after 25% of the wetland storage volume has been lost

It is important to note that maintenance requirements for stormwater wetlands are particularly high during the first few years following installation and vegetation establishment. Regular inspection and maintenance during these first few years is crucial to the success of the wetland as an effective stormwater management practice.

It is also important to note that sediments excavated from stormwater wetlands that do not receive stormwater runoff from stormwater hotspots are typically not considered to be toxic and can be safely disposed through either land application or landfilling. Check with the local development review authority to identify any additional constraints on the disposal of sediments excavated from stormwater wetlands.

Additional Resources

Atlanta Regional Commission (ARC). 2001. "Stormwater Wetlands." *Georgia Stormwater Management Manual*. Volume 2. Technical Handbook. Section 3.2.2. Atlanta Regional Commission. Atlanta, GA. Available Online: <http://www.georgia-stormwater.com/>.

Minnesota Pollution Control Agency (MPCA). 2006. "Stormwater Wetlands." *Minnesota Stormwater Manual*. Chapter 12. Minnesota Pollution Control Agency. Available Online: <http://www.pca.state.mn.us/water/stormwater/stormwater-manual.html>.

8.6.3 Bioretention Areas

Description

Bioretention areas, which may also be classified as a low impact development practice (Section 7.8.13), are shallow depressional areas that are filled with an engineered soil mix and are planted with trees, shrubs and other herbaceous vegetation. They are designed to capture and temporarily store stormwater runoff in the engineered soil mix, where it is subjected to the hydrologic processes of evaporation and transpiration, before being conveyed back into the storm drain system through an underdrain or allowed to infiltrate into the surrounding soils. This allows them to provide measurable reductions in post-construction stormwater runoff rates, volumes and pollutant loads on development sites.



(Source: Center for Watershed Protection)

<p style="text-align: center;"><u>KEY CONSIDERATIONS</u></p> <p>DESIGN CRITERIA:</p> <ul style="list-style-type: none"> • Bioretention areas should be designed to completely drain within 48 hours of the end of a rainfall event • A maximum ponding depth of 9 inches is recommended within bioretention areas to help prevent the formation of nuisance ponding conditions • Unless a shallow water table is found on the development site, bioretention area planting beds should be at least 3 feet deep <p>BENEFITS:</p> <ul style="list-style-type: none"> • Helps restore pre-development hydrology on development sites and reduces post-construction stormwater runoff rates, volumes and pollutant loads • Can be integrated into development plans as attractive landscaping features <p>LIMITATIONS:</p> <ul style="list-style-type: none"> • Can only be used to manage runoff from relatively small drainage areas of 5 acres in size 	<p style="text-align: center;"><u>STORMWATER MANAGEMENT "CREDITS"</u></p> <ul style="list-style-type: none"> <input checked="" type="checkbox"/> Runoff Reduction <input checked="" type="checkbox"/> Water Quality Protection <input checked="" type="checkbox"/> Aquatic Resource Protection <input checked="" type="checkbox"/> Overbank Flood Protection <input checked="" type="checkbox"/> Extreme Flood Protection <p><input checked="" type="checkbox"/> = practice has been assigned quantifiable stormwater management "credits" that can be used to address this SWM Criteria</p>						
<p style="text-align: center;"><u>SITE APPLICABILITY</u></p> <table border="0"> <tr> <td><input checked="" type="checkbox"/> Rural Use</td> <td><input type="checkbox"/> Construction Cost</td> </tr> <tr> <td><input checked="" type="checkbox"/> Suburban Use</td> <td><input type="checkbox"/> Maintenance</td> </tr> <tr> <td><input checked="" type="checkbox"/> Urban Use</td> <td><input type="checkbox"/> Area Required</td> </tr> </table>	<input checked="" type="checkbox"/> Rural Use	<input type="checkbox"/> Construction Cost	<input checked="" type="checkbox"/> Suburban Use	<input type="checkbox"/> Maintenance	<input checked="" type="checkbox"/> Urban Use	<input type="checkbox"/> Area Required	<p style="text-align: center;"><u>STORMWATER MANAGEMENT PRACTICE PERFORMANCE</u></p> <p>Runoff Reduction 40%/80% - Annual Runoff Volume Varies¹ - Runoff Reduction Volume</p> <p>Pollutant Removal² 80% - Total Suspended Solids 60% - Total Phosphorus 60% - Total Nitrogen N/A - Metals 80% - Pathogens</p> <p>1 = varies according to storage capacity of the bioretention area 2 = expected annual pollutant load removal</p>
<input checked="" type="checkbox"/> Rural Use	<input type="checkbox"/> Construction Cost						
<input checked="" type="checkbox"/> Suburban Use	<input type="checkbox"/> Maintenance						
<input checked="" type="checkbox"/> Urban Use	<input type="checkbox"/> Area Required						

Discussion

Bioretention areas (also known as *bioretention filters* and *biofilters*), which may also be classified as a low impact development practice (Section 7.8.13), are shallow depressional areas that are filled with an engineered soil mix and are planted with trees, shrubs and other herbaceous vegetation. They are designed to capture and temporarily store stormwater runoff in the engineered soil mix, where it is subjected to the hydrologic processes of evaporation and transpiration, before being conveyed back into the storm drain system through an underdrain or allowed to infiltrate into the surrounding soils. This allows them to provide measurable reductions in post-construction stormwater runoff rates, volumes and pollutant loads on development sites.

Bioretention areas (Figure 8.19) are one of the most effective stormwater management practices that can be used in coastal Georgia to reduce post-construction stormwater runoff rates, volumes and pollutant loads. They also provide a number of other benefits, including improved aesthetics, wildlife habitat, urban heat island mitigation and improved air quality. Bioretention areas differ from rain gardens (Section 7.8.9), in that they are designed to receive stormwater runoff from larger drainage areas and may be equipped with an underdrain (Figure 8.20).



Figure 8.19: Various Bioretention Areas

Stormwater Management “Credits”

Bioretention areas have been assigned quantifiable stormwater management “credits” that can be used to help satisfy the SWM Criteria presented in this CSS:

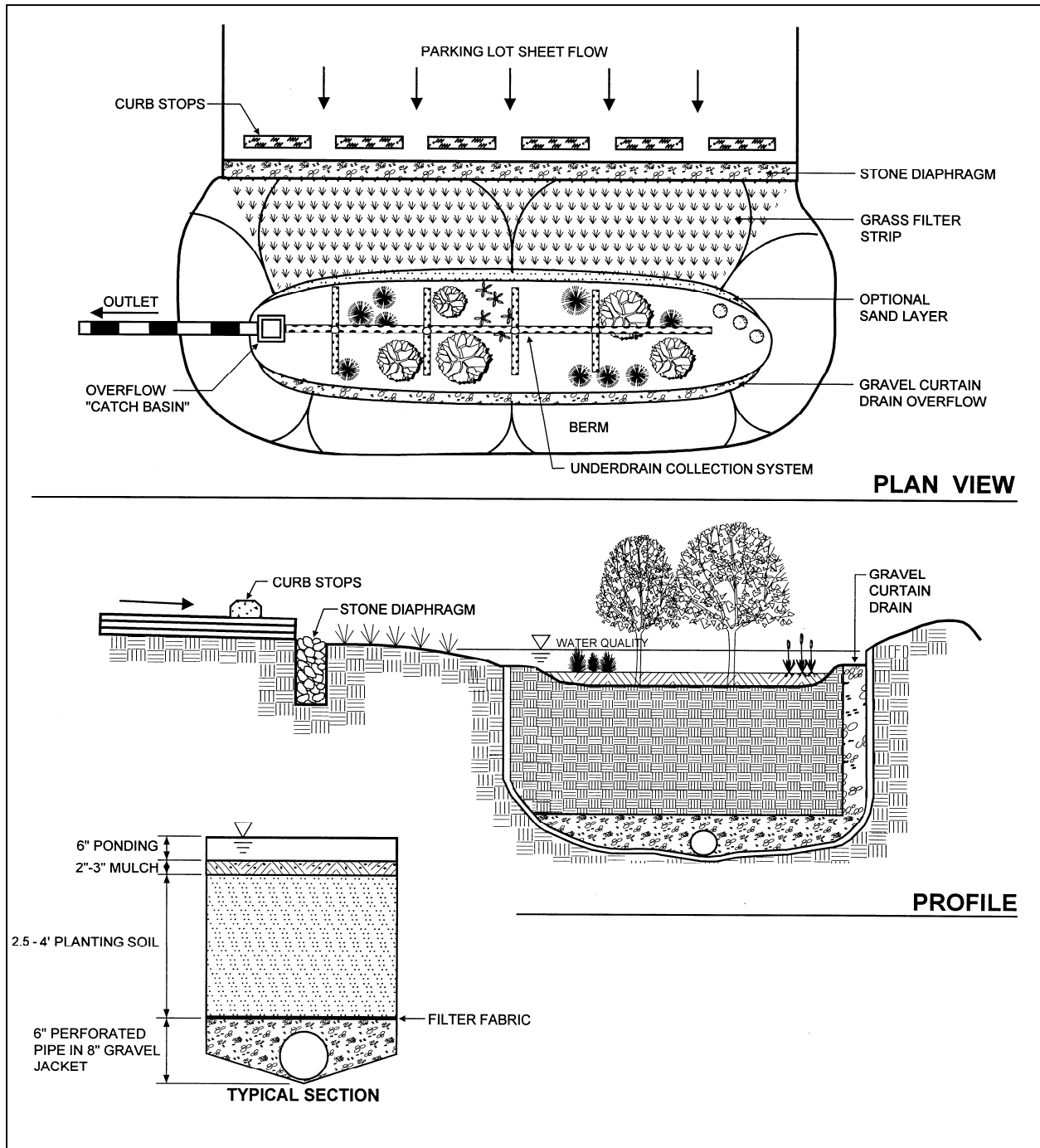

Figure 8.20: Schematic of a Typical Bioretention Area

(Source: Center for Watershed Protection)

- Stormwater Runoff Reduction: Subtract 100% of the storage volume provided by a non-underdrained *bioretention* area from the runoff reduction volume (RR_v) conveyed through the *bioretention* area. Subtract 50% of the storage volume provided by an underdrained *bioretention* area from the runoff reduction volume (RR_v) conveyed through the *bioretention* area.

- Water Quality Protection: Assume that a *bioretention area* provides an 80% reduction in TSS loads, a 60% reduction in TN loads and an 80% reduction in bacteria loads.
- Aquatic Resource Protection: Although uncommon, on some development sites, a *bioretention area* can be designed to provide 24-hours of extended detention for the aquatic resource protection volume (ARP_v).
- Overbank Flood Protection: Although relatively rare, on some development sites, a *bioretention area* can be designed to attenuate the overbank peak discharge (Q_{p25}).
- Extreme Flood Protection: Although relatively rare, on some development sites, a *bioretention area* can be designed to attenuate the extreme peak discharge (Q_{p100}).

The storage volume provided by a bioretention area can be determined using the following equation:

$$\text{Storage Volume} = \text{Surface Area} \times [\text{Ponding Depth} + (\text{Depth of Planting Bed} \times \text{Void Ratio})]$$

A void ratio (i.e., void space/total volume) of 0.32 should be used in all storage volume calculations, unless more specific planting bed void ratio data are available.

In order to manage post-construction stormwater runoff and be eligible for these "credits," it is *recommended* that bioretention areas satisfy the planning and design criteria outlined below.

Overall Feasibility

The criteria listed in Table 8.10 should be evaluated to determine whether or not a bioretention area is appropriate for use on a development site.

Table 8.10: Factors to Consider When Evaluating the Overall Feasibility of Using a Bioretention Area on a Development Site	
Site Characteristic	Criteria
Drainage Area	Although bioretention areas can be used to manage stormwater runoff from contributing drainage areas as large as 5 acres in size, contributing drainage areas of between 2,500 square feet and 2 acres are preferred.
Area Required	Bioretention area surface area requirements vary according to the size of the contributing drainage area and the infiltration rate of the soils on which the bioretention area will be located. In general, bioretention areas require about 5-10% of the size of their contributing drainage areas.
Slope	Although bioretention areas may be used on development sites with slopes of up to 6%, they should be designed with slopes that are as close to flat as possible to help ensure that stormwater runoff is evenly distributed over the planting bed.
Minimum Head	Bioretention areas may be designed with a maximum ponding depth of 12 inches, although a ponding depth of 9 inches is recommended to help prevent the formation of nuisance ponding conditions. Unless a shallow water table is found on the development site, all bioretention area planting beds should be at least 36 inches deep.
Minimum Depth to Water Table	2 feet

Table 8.10: Factors to Consider When Evaluating the Overall Feasibility of Using a Bioretention Area on a Development Site	
Site Characteristic	Criteria
Soils	Bioretention areas should be designed to completely drain within 48 hours of the end of a rainfall event. Consequently, non-underdrained bioretention areas generally should not be used on development sites that have soils with infiltration rates of less than 0.25 inches per hour (i.e., hydrologic soil group C and D soils). Underdrained bioretention areas may be used to manage stormwater runoff on development sites that have soils with infiltration rates of less than 0.25 inches per hour.

Feasibility in Coastal Georgia

Several site characteristics commonly encountered in coastal Georgia may present challenges to site planning and design teams that are interested in using bioretention areas to manage post-construction stormwater runoff on a development site. Table 8.11 identifies these common site characteristics and describes how they influence the use of bioretention areas on development sites. The table also provides site planning and design teams with some ideas about how they can work around these potential constraints.

Table 8.11: Challenges Associated with Using Bioretention Areas in Coastal Georgia		
Site Characteristic	How it Influences the Use of Bioretention Areas	Potential Solutions
<ul style="list-style-type: none"> Poorly drained soils, such as hydrologic soil group C and D soils 	<ul style="list-style-type: none"> Reduces the ability of bioretention areas to reduce stormwater runoff rates, volumes and pollutant loads. 	<ul style="list-style-type: none"> Use underdrained bioretention areas to manage post-construction stormwater runoff in these areas. Use additional low impact development and stormwater management practices to supplement the stormwater management benefits provided by bioretention areas in these areas. Use rainwater harvesting (Section 7.8.12), small stormwater wetlands (i.e., pocket wetlands) (Section 8.6.2) or wet swales (Section 8.6.6), instead of bioretention areas to intercept and treat stormwater runoff in these areas.

Table 8.11: Challenges Associated with Using Bioretention Areas in Coastal Georgia

Site Characteristic	How it Influences the Use of Bioretention Areas	Potential Solutions
<ul style="list-style-type: none"> • <i>Well drained soils, such as hydrologic soil group A and B soils</i> 	<ul style="list-style-type: none"> • Enhances the ability of bioretention areas to reduce stormwater runoff rates, volumes and pollutant loads, but may allow stormwater pollutants to reach groundwater aquifers with greater ease. 	<ul style="list-style-type: none"> • Avoid the use of infiltration-based stormwater management practices, including non-underdrained bioretention areas, at stormwater hotspots and in areas known to provide groundwater recharge to water supply aquifers, unless adequate pretreatment is provided upstream of them. • Use bioretention areas and dry swales (Section 8.6.6) with liners and underdrains at stormwater hotspots and in areas known to provide groundwater recharge to water supply aquifers.
<ul style="list-style-type: none"> • <i>Flat terrain</i> 	<ul style="list-style-type: none"> • May be difficult to provide adequate drainage and may cause stormwater runoff to pond in the bioretention area for extended periods of time. 	<ul style="list-style-type: none"> • Ensure that the underlying native soils will allow the bioretention area to drain completely within 48 hours of the end of a rainfall event to prevent the formation of nuisance ponding conditions.
<ul style="list-style-type: none"> • <i>Shallow water table</i> 	<ul style="list-style-type: none"> • May be difficult to provide 2 feet of clearance between the bottom of the bioretention area and the top of the water table. • May occasionally cause stormwater runoff to pond in the bioretention area. 	<ul style="list-style-type: none"> • Ensure that the distance from the bottom of the bioretention area to the top of the water table is at least 2 feet. • Reduce the depth of the planting bed to 18 inches. • Use stormwater ponds (Section 8.6.1), stormwater wetlands (Section 8.6.2) and wet swales (Section 8.6.6), instead of bioretention areas to intercept and treat stormwater runoff in these areas.
<ul style="list-style-type: none"> • <i>Tidally-influenced drainage system</i> 	<ul style="list-style-type: none"> • May occasionally prevent stormwater runoff from being conveyed through a bioretention area, particularly during high tide. 	<ul style="list-style-type: none"> • Investigate the use of other low impact development and stormwater management practices, such as rainwater harvesting (Section 7.8.12) to manage post-construction stormwater runoff in these areas.

Site Applicability

Bioretention areas can be used to manage post-construction stormwater runoff on a wide variety of development sites, including residential, commercial and institutional development sites in rural, suburban and urban areas. They are well suited to “receive” stormwater runoff from nearly all small impervious and pervious drainage areas, including local streets and roadways, highways, driveways, small parking areas and disturbed pervious areas (e.g., lawns, parks, community open spaces). When compared with other stormwater management practices, bioretention areas have a moderate construction cost, a moderate maintenance burden and require a relatively small amount of surface area.

Planning and Design Criteria

It is *recommended* that bioretention areas meet all of the following criteria to be eligible for the stormwater management “credits” described above:

General Planning and Design

- Although bioretention areas can be used to manage post-construction stormwater runoff from contributing drainage areas as large as 5 acres in size, contributing drainage areas of between 2,500 square feet and 2 acres are preferred. Multiple bioretention areas can be used to manage stormwater runoff from larger contributing drainage areas.
- Although bioretention areas may be used on development sites with slopes of up to 6%, they should be designed with slopes that are as close to flat as possible to help ensure that stormwater runoff is evenly distributed over the planting bed.
- Bioretention areas can be designed without an underdrain on development sites that have underlying soils with an infiltration rate of 0.25 inches per hour (in/hr) or greater, as determined by NRCS soil survey data and subsequent field testing. Field infiltration test protocol, such as that provided by the City of Portland, OR (Portland, OR, 2008) on the following website: <http://www.portlandonline.com/shared/cfm/image.cfm?id= 202911>, can be used to conduct field testing, but should be approved by the local development review authority prior to use.
- Although the number of infiltration tests needed on a development site will ultimately be determined by the local development review authority, at least one infiltration test is recommended for each bioretention area that will be used on the development site. If the infiltration rate of the underlying soils on the development site is not 0.25 inches per hour (in/hr) or greater, an underdrain should be included in the bioretention area design.
- Since clay lenses or any other restrictive layers located below the bottom of a bioretention area will reduce soil infiltration rates, infiltration testing should be conducted within any confining layers that are found within 4 feet of the bottom of a proposed bioretention area.
- Bioretention areas should be designed to provide enough storage for the stormwater runoff volume generated by the target runoff reduction rainfall event (e.g., 85th percentile rainfall event). The required dimensions of an underdrained bioretention area can be determined using the following equation, which is based on Darcy’s Law:

$$A_{\text{bio}} = (RR_v)(d_{\text{bio}}) \div [(k_{\text{bio}})(h_{\text{bio}} + d_{\text{bio}})(t_{\text{drain}})]$$

Where:

A_{bio} = surface area of bioretention area (ft²)

RR_v = stormwater runoff volume generated by target runoff reduction rainfall event (ft³) (e.g., 85th percentile rainfall event)

d_{bio} = depth of bioretention area planting bed (ft) (use 36 inches or more, unless a shallow water table is found on the development site)

- k_{bio} = coefficient of permeability of bioretention area planting bed (ft/day) (use $k_{bio} = 0.5$ ft/day for engineered soil mix specified below)
- h_{bio} = average height of ponded water above bioretention area (ft) (use 50% of maximum ponding depth)
- t_{drain} = design bioretention area drain time (days) (use 48 hours or less)

The required dimensions of a non-underdrained bioretention area can be determined using the following equation, which is also based on Darcy's Law:

$$A_{bio} = (RR_v)(d_{bio}) \div [(i_{soil})(h_{bio} + d_{bio})(t_{drain})]$$

Where:

- A_{bio} = surface area of bioretention area (ft²)
- RR_v = stormwater runoff volume generated by target runoff reduction rainfall event (ft³) (e.g., 85th percentile rainfall event)
- d_{bio} = depth of bioretention area planting bed (ft) (use 36 inches or more, unless a shallow water table is found on the development site)
- i_{soil} = infiltration rate of underlying native soils (ft/day) or coefficient of permeability of bioretention area planting bed (ft/day) (use $k_{bio} = 0.5$ ft/day for engineered soil mix specified below), whichever is less
- h_{bio} = average height of ponded water above bioretention area (ft) (use 50% of maximum ponding depth)
- t_{drain} = design bioretention area drain time (days) (use 48 hours or less)

- Bioretention areas should be designed to completely drain within 48 hours of the end of a rainfall event. Where site characteristics allow, it is preferable to design bioretention areas to drain within 24 hours of the end of a rainfall event to help prevent the formation of nuisance ponding conditions.
- Unless a shallow water table is found on the development site, all bioretention area planting beds should be at least 36 inches deep. If a shallow water table is found on the development site, the depth of the planting bed may be reduced to 18 inches.
- The soils used within bioretention area planting beds should be an engineered soil mix that meets the following specifications:
 - Texture: Sandy loam or loamy sand.
 - Sand Content: Soils should contain 85%-88% clean, washed sand.
 - Topsoil Content: Soils should contain 8%-12% topsoil.
 - Organic Matter Content: Soils should contain 3%-5% organic matter.
 - Infiltration Rate: Soils should have an infiltration rate of at least 0.25 inches per hour (in/hr), although an infiltration rate of between 1 and 2 in/hr is preferred.
 - Phosphorus Index (P-Index): Soils should have a P-Index of less than 30.
 - Exchange Capacity (CEC): Soils should have a CEC that exceeds 10 milliequivalents (meq) per 100 grams of dry weight.
 - pH: Soils should have a pH of 6-8.
- The organic matter used within a bioretention area planting bed should be a well-aged compost that meets the specifications outlined in Section 7.8.1.
- Bioretention areas should be preceded by a pea gravel (i.e., ASTM D 448 Size No. 8, 3/8" to 1/8") diaphragm or equivalent level spreader device (e.g., concrete sills, curb stops, curbs with "sawteeth" cut into them) and appropriate pretreatment device, such as a vegetated filter strip (Section 7.8.6) or sediment forebay.
- If no underdrain is required, underlying native soils should be separated from the planting bed by a thin, 2 to 4 inch layer of choker stone (i.e., ASTM D 448 size No. 8, 3/8" to 1/8" or

ASTM D 448 size No. 89, 3/8" to 1/16"). The choker stone should be placed between the planting bed and the underlying native soils.

- If an underdrain is required, it should be placed beneath the planting bed. The underdrain should consist of a 4 to 6 inch perforated PVC (AASHTO M 252) pipe bedded in an 8 inch layer of clean, washed stone. The pipe should have 3/8 inch perforations, spaced 6 inches on center, and should have a minimum slope of 0.5%. The clean, washed stone should be ASTM D448 size No. 57 stone (i.e., 1-1/2 to 1/2 inches in size) and should be separated from the planting bed by a thin, 2 to 4 inch layer of choker stone (i.e., ASTM D 448 size No. 8, 3/8" to 1/8" or ASTM D 448 size No. 89, 3/8" to 1/16").
- Bioretention areas should be designed with side slopes of 3:1 (H:V) or flatter.
- The depth from the bottom of a bioretention area to the top of the water table should be at least 2 feet to help prevent ponding and ensure proper operation of the bioretention area. On development sites with high water tables, small stormwater wetlands (i.e., pocket wetlands) (Section 8.6.2) should be used to intercept and treat post-construction stormwater runoff.
- To prevent damage to building foundations and contamination of groundwater aquifers, bioretention areas, unless equipped with a waterproof liner (e.g., 30 mil (0.030 inch) polyvinylchloride (PVC) or equivalent), should be located at least:
 - 10 feet from building foundations
 - 10 feet from property lines
 - 100 feet from private water supply wells
 - 1,200 feet from public water supply wells
 - 100 feet from septic systems
 - 100 feet from surface waters
 - 400 feet from public water supply surface waters
- Consideration should be given to the stormwater runoff rates and volumes generated by larger storm events (e.g., 25-year, 24-hour storm event) to help ensure that these larger storm events are able to safely bypass the bioretention area. An overflow system should be designed to convey the stormwater runoff generated by these larger storm events safely out of the bioretention area. Methods that can be used to accommodate the stormwater runoff rates and volumes generated by these larger storm events include:
 - Using yard drains or storm drain inlets set at the maximum ponding depth to collect excess stormwater runoff.
 - Placing a vertical gravel curtain drain at the downstream end of the bioretention area (Figure 8.20) to provide additional conveyance of stormwater runoff into the underdrain after the planting bed has been filled.
 - Placing a perforated pipe (e.g., underdrain) near the top of the planting bed to provide additional conveyance of stormwater runoff after the planting bed has been filled.

Landscaping

- A landscaping plan should be prepared for all bioretention areas. The landscaping plan should be reviewed and approved by the local development review authority prior to construction.
- Vegetation commonly planted in bioretention areas includes native trees, shrubs and other herbaceous vegetation. When developing a landscaping plan, site planning and design teams should choose vegetation that will be able to stabilize soils and tolerate the stormwater runoff rates and volumes that will pass through the bioretention area. Vegetation used in bioretention areas should also be able to tolerate both wet and dry conditions. See Appendix F of Volume 2 of the *Georgia Stormwater Management Manual* (ARC, 2001) for a list of grasses and other plants that are appropriate for use in bioretention areas installed in the state of Georgia.

- A mulch layer, consisting of 2-4 inches of fine shredded hardwood mulch or shredded hardwood chips, should be included on the surface of the bioretention area.
- Methods used to establish vegetative cover within a bioretention area should achieve at least 75 percent vegetative cover one year after installation.
- To help prevent soil erosion and sediment loss, landscaping should be provided immediately after the bioretention area has been installed. Temporary irrigation may be needed to quickly establish vegetative cover within a bioretention area.

Construction Considerations

To help ensure that bioretention areas are successfully installed on a development site, site planning and design teams should consider the following recommendations:

- To prevent practice failure due to sediment accumulation and pore clogging, bioretention areas should only be installed after their contributing drainage areas have been completely stabilized. To help prevent practice failure, stormwater runoff may be diverted around the bioretention area until the contributing drainage area has become stabilized.
- Simple erosion and sediment control measures, such as temporary seeding and erosion control mats, should be used within the bioretention area. Appropriate measures should be taken (e.g., temporary diversion) to divert post-construction stormwater runoff around a bioretention area until vegetative cover has been established.
- To help prevent soil compaction, heavy vehicular and foot traffic should be kept out of bioretention areas before, during and after construction. This can typically be accomplished by clearly delineating bioretention areas on all development plans and, if necessary, protecting them with temporary construction fencing.
- The native soils along the bottom of the bioretention area should be scarified or tilled to a depth of 3 to 4 inches prior to the placement of the underdrain and/or engineered soil mix.
- Construction contracts should contain a replacement warranty that covers at least three growing seasons to help ensure adequate growth and survival of the vegetation planted within a bioretention area.

Maintenance Requirements

Maintenance is very important for bioretention areas, particularly in terms of ensuring that they continue to provide measurable stormwater management benefits over time. Consequently, a legally binding inspection and maintenance agreement and plan should be created to help ensure that they are properly maintained after construction is complete. Table 8.12 provides a list of the routine maintenance activities typically associated with bioretention areas.

Activity	Schedule
<ul style="list-style-type: none"> • Water to promote plant growth and survival. • Inspect bioretention area following rainfall events. • Plant replacement vegetation in any eroded areas. 	As Needed (Following Construction)
<ul style="list-style-type: none"> • Prune and weed bioretention area to maintain appearance. • Remove accumulated trash and debris. • Replace mulch as needed. 	Regularly (Monthly)

Table 8.12: Routine Maintenance Activities Typically Associated with Bioretention Areas

Activity	Schedule
<ul style="list-style-type: none"> • Inspect inflow area for sediment accumulation. Remove any accumulated sediment or debris. • Inspect bioretention area for erosion and the formation of rills and gullies. Plant replacement vegetation in any eroded areas. • Inspect bioretention area for dead or dying vegetation. Plant replacement vegetation as needed. • Test planting bed for pH. If the pH is below 5.2, limestone should be applied. If the pH is above 8.0, iron sulfate and sulfur should be applied. 	Annually (Semi-Annually During First Year)
<ul style="list-style-type: none"> • Replace mulch. • Replace pea gravel diaphragm, if necessary 	Every 2 to 3 Years

It should be noted that sediments removed from bioretention areas that do not receive stormwater runoff from stormwater hotspots are typically not considered to be toxic and can be safely disposed through either land application or landfilling. Check with the local development review authority to identify any additional constraints on the disposal of sediments removed from bioretention areas.

Additional Resources

Atlanta Regional Commission (ARC). 2001. "Bioretention Areas." *Georgia Stormwater Management Manual*. Volume 2. Technical Handbook. Section 3.2.3. Atlanta Regional Commission. Atlanta, GA. Available Online: <http://www.georgia-stormwater.com/>.

Hunt, W.F. and W.G. Lord. 2006. "Bioretention Performance, Design, Construction and Maintenance." *North Carolina Cooperative Extension Service Bulletin*. Urban Waterways Series. AG-588-5. North Carolina State University. Raleigh, NC. Available Online: <http://www.bae.ncsu.edu/stormwater/PublicationFiles/Bioretention2006.pdf>.

Biohabitats, Inc. 2005. *Bioretention Guidance*. Prepared for: Lake County, OH. Stormwater Management Department. Available Online: <http://www2.lakecountyohio.org/smd/Forms.htm>.

THIS PAGE INTENTIONALLY LEFT BLANK

8.6.4 Filtration Practices

Description

Filtration practices are multi-chamber structures designed to treat stormwater runoff using the physical processes of screening and filtration. After passing through the filter media (e.g., sand), stormwater runoff is typically returned to the conveyance system through an underdrain. Because they have very few site constraints beyond head requirements (i.e., vertical distance between inlet and outlet), filtration practices can often be used on development sites where other stormwater management practices, such as stormwater ponds (Section 8.6.1) and infiltration practices (Section 8.6.5), can not.



(Source: Atlanta Regional Commission, 2001)

<p style="text-align: center;"><u>KEY CONSIDERATIONS</u></p> <p>DESIGN CRITERIA:</p> <ul style="list-style-type: none"> • Maximum contributing drainage area of 10 acres for surface filters; maximum contributing drainage area of 2 acres for perimeter filters • Filtration practices should be designed to completely drain within 36 hours of the end of a rainfall event • A maximum ponding depth of 12 inches is recommended to help prevent the formation of nuisance ponding conditions • Typically require 3 to 6 feet of head, although perimeter filters may be designed to function on development sites with as little as 2 feet of head <p>BENEFITS:</p> <ul style="list-style-type: none"> • Provides moderate to high removal of many of the pollutants of concern typically contained in post-construction stormwater runoff • Ideal for intercepting and treating stormwater runoff from small, highly impervious areas, including stormwater hotspots <p>LIMITATIONS:</p> <ul style="list-style-type: none"> • Relatively high construction and maintenance costs • Should not be used to “receive” stormwater runoff that contains high sediment loads 	<p style="text-align: center;"><u>STORMWATER MANAGEMENT “CREDITS”</u></p> <p>Runoff Reduction</p> <ul style="list-style-type: none"> <input checked="" type="checkbox"/> Water Quality Protection <input checked="" type="checkbox"/> Aquatic Resource Protection <input checked="" type="checkbox"/> Overbank Flood Protection <input checked="" type="checkbox"/> Extreme Flood Protection <p><input checked="" type="checkbox"/> = practice has been assigned quantifiable stormwater management “credits” that can be used to address this SWM Criteria</p>
<p style="text-align: center;"><u>SITE APPLICABILITY</u></p> <ul style="list-style-type: none"> * Rural Use <input checked="" type="checkbox"/> Suburban Use <input checked="" type="checkbox"/> Urban Use <input type="checkbox"/> Construction Cost <input type="checkbox"/> Maintenance <input type="checkbox"/> Area Required 	<p style="text-align: center;"><u>STORMWATER MANAGEMENT PRACTICE PERFORMANCE</u></p> <p>Runoff Reduction 0% - Annual Runoff Volume 0% - Runoff Reduction Volume</p> <p>Pollutant Removal¹ 80% - Total Suspended Solids 60% - Total Phosphorus 40% - Total Nitrogen 50% - Metals 40% - Pathogens</p> <p>¹ = expected annual pollutant load removal</p>

Description

Filtration practices are multi-chamber structures designed to treat stormwater runoff using the physical processes of screening and filtration. Most filtration practices are two-chamber structures. The first chamber is a sediment forebay or sedimentation chamber, which works to remove trash, debris and larger sediment particles. The second chamber is a filtration chamber, which removes additional stormwater pollutants by conveying stormwater runoff through a filter media. After passing through the filter media (e.g., sand), stormwater runoff is typically returned to the conveyance system through an underdrain. Because they have very few site constraints beyond head requirements (i.e., vertical distance between inlet and outlet), filtration practices can often be used on development sites where other stormwater management practices, such as stormwater ponds (Section 8.6.1) and infiltration practices (Section 8.6.5), can not.

Filtration practices treat stormwater runoff primarily through a combination of the physical processes of gravitational settling, physical screening, filtration, absorption and adsorption. The filtration process effectively removes suspended solids, particulate matter, heavy metals and fecal coliform bacteria and other pathogens from stormwater runoff. Surface filters that are designed with vegetative cover provide additional opportunities for biological uptake of nutrients by the vegetation and for biological decomposition of other stormwater pollutants, such as hydrocarbons.

There are several variations of filtration practices that can be used to manage post-construction stormwater runoff on development sites, the most common of which include surface sand filters and perimeter sand filters (Figure 8.21). A brief description of each of these design variants is provided below:

- **Surface Sand Filters:** Surface sand filters (Figure 8.22) are ground-level, open air practices that consist of a pretreatment forebay and a filter bed chamber. Surface sand filters can treat stormwater runoff from contributing drainage areas as large as 10 acres in size and are typically designed as off-line stormwater management practices. Surface sand filters can be designed as excavations, with earthen side slopes, or as structural concrete or block structures.
- **Perimeter Sand Filters:** Perimeter sand filters (Figure 8.23) are enclosed stormwater management practices that are typically located just below grade in a trench along the perimeter of parking lot, driveway or other impervious surface. Perimeter sand filters

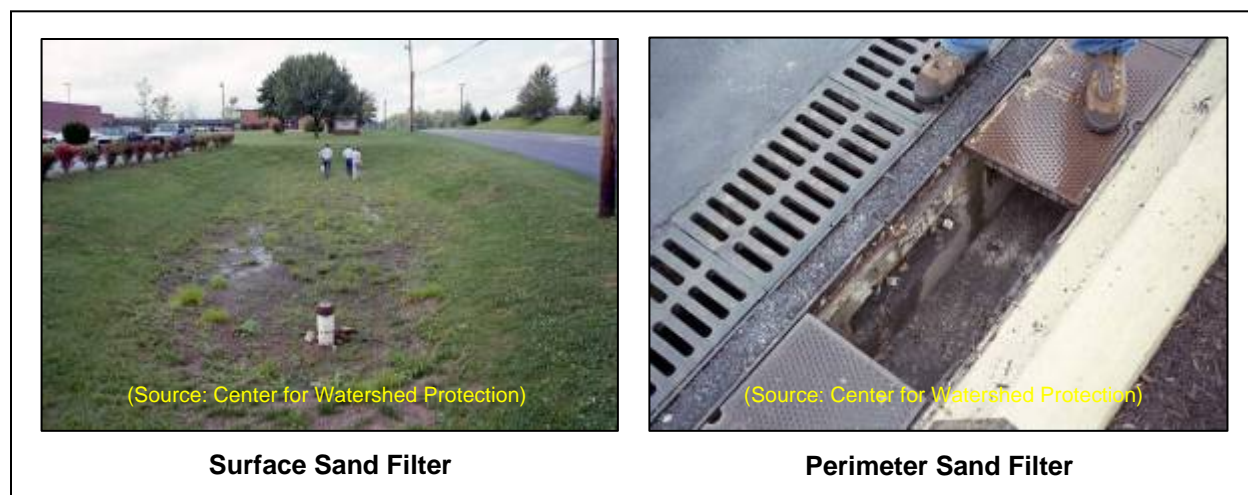

Figure 8.21: Various Filtration Practices

consist of a pretreatment forebay and a filter bed chamber. Stormwater runoff is conveyed into a perimeter sand filter through grate inlets located directly above the system.

Other design variants, including the underground sand filter and the organic filter, are intended primarily for use on ultra-urban development sites, where space is limited, or for use at stormwater hotspots, where enhanced removal of particular stormwater pollutants (e.g., heavy metals) is desired. Additional information about these *limited application stormwater management practices* is provided in Section 8.7 of this CSS.

Stormwater Management “Credits”

Filtration practices have been assigned quantifiable stormwater management “credits” that can be used to help satisfy the SWM Criteria presented in this CSS:

- Stormwater Runoff Reduction: None. Although *filtration practices* provide moderate to high removal of many of the pollutants of concern typically contained in post-construction stormwater runoff, recent research shows that they provide little, if any, reduction of post-construction stormwater runoff volumes (Hirschman et al., 2008).
- Water Quality Protection: Assume that a *filtration practice* provides an 80% reduction in TSS loads, a 30% reduction in TN loads and a 40% reduction in bacteria loads.
- Aquatic Resource Protection: Although uncommon, on some development sites, a *filtration practice* can be designed to provide 24-hours of extended detention for the aquatic resource protection volume (ARP_v).
- Overbank Flood Protection: Although relatively rare, on some development sites, a *filtration practice* can be designed to attenuate the overbank peak discharge (Q_{p25}).
- Extreme Flood Protection: Although relatively rare, on some development sites, a *filtration practice* can be designed to attenuate the extreme peak discharge (Q_{p100}).

In order to manage post-construction stormwater runoff and be eligible for these “credits,” it is *recommended* that filtration practices satisfy the planning and design criteria outlined below.

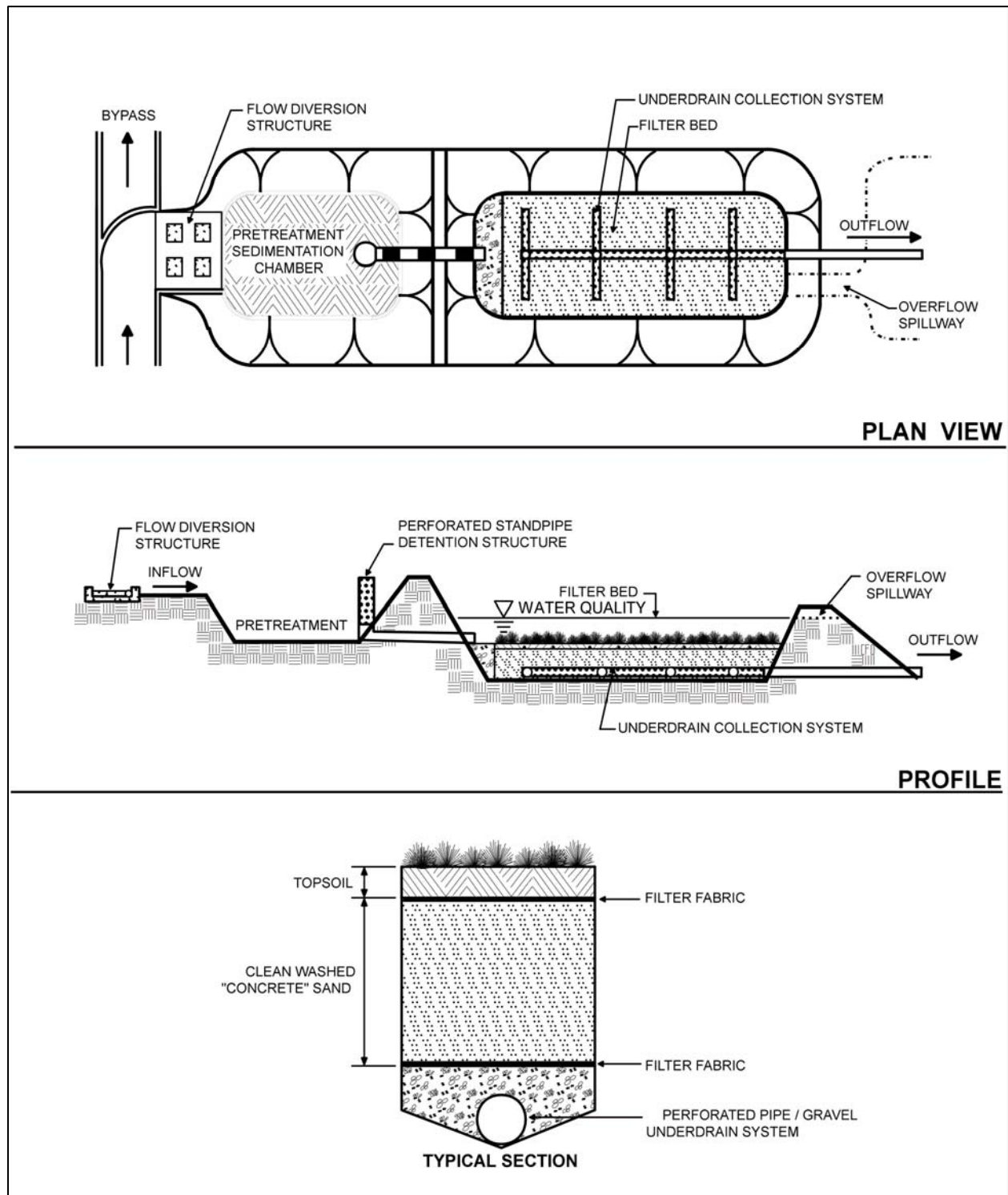

Figure 8.22: Schematic of a Typical Surface Sand Filter
 (Source: Center for Watershed Protection)

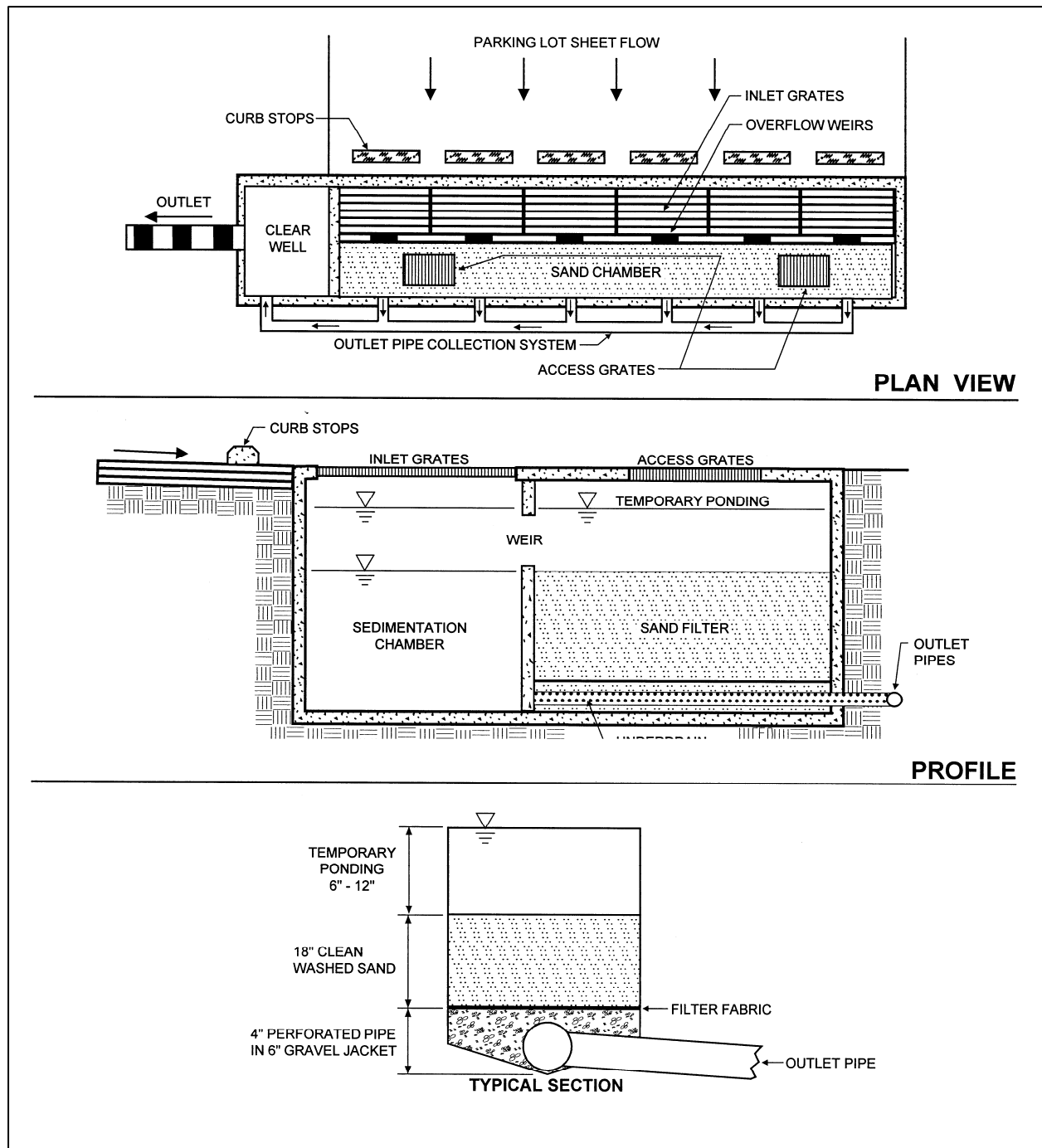

Figure 8.23: Schematic of a Typical Perimeter Sand Filter
 (Source: Center for Watershed Protection)

Overall Feasibility

The criteria listed in Table 8.13 should be evaluated to determine whether or not a filtration practice is appropriate for use on a development site.

Table 8.13: Factors to Consider When Evaluating the Overall Feasibility of Using a Filtration Practice on a Development Site	
Site Characteristic	Criteria
Drainage Area	Surface sand filters can be used to manage stormwater runoff from contributing drainage areas of up to 10 acres in size. Perimeter sand filters can be used to manage stormwater runoff from contributing drainage areas of up to 2 acres in size.
Area Required	Filtration practice surface area requirements vary according to the size of the contributing drainage area and the amount of head available at the development site. In general, filtration practices require about 3-5% of the size of their contributing drainage areas.
Slope	Although filtration practices may be used on development sites with slopes of up to 6%, they should be designed with slopes that are as close to flat as possible to help ensure that stormwater runoff is evenly distributed over the filter bed.
Minimum Head	5 feet for surface sand filters 2 to 3 feet for perimeter sand filters
Minimum Depth to Water Table	2 feet
Soils	No restrictions

Feasibility in Coastal Georgia

Several site characteristics commonly encountered in coastal Georgia may present challenges to site planning and design teams that are interested in using filtration practices to manage post-construction stormwater runoff on development and redevelopment sites. Table 7.15 identifies these common site characteristics and describes how they influence the use of filtration practices. The table also provides site planning and design teams with some ideas about how they can work around these potential design constraints.

Table 8.14: Challenges Associated with Using Filtration Practices in Coastal Georgia		
Site Characteristic	How it Influences the Use of Filtration Practices	Potential Solutions
<ul style="list-style-type: none"> <i>Poorly drained soils, such as hydrologic soil group C and D soils</i> 	<ul style="list-style-type: none"> Since they are equipped with underdrains, the presence of poorly drained soils does not influence the use of filtration practices on development sites. 	

Table 8.14: Challenges Associated with Using Filtration Practices in Coastal Georgia

Site Characteristic	How it Influences the Use of Filtration Practices	Potential Solutions
<ul style="list-style-type: none"> • <i>Well drained soils</i>, such as hydrologic soil group A and B soils 	<ul style="list-style-type: none"> • May allow stormwater pollutants to reach groundwater aquifers with greater ease. 	<ul style="list-style-type: none"> • Use filtration practices and bioretention areas (Section 8.6.3) with liners and underdrains to intercept and treat stormwater runoff at stormwater hotspots and in areas known to provide groundwater recharge to water supply aquifers. • In areas that are not considered to be stormwater hotspots and areas that do not provide groundwater recharge to water supply aquifers, use non-underdrained bioretention areas (Section 8.6.3) and infiltration practices (Section 8.6.5) to significantly reduce stormwater runoff rates, volumes and pollutant loads.
<ul style="list-style-type: none"> • <i>Flat terrain</i> 	<ul style="list-style-type: none"> • May be difficult to provide adequate drainage and may cause stormwater runoff to pond in the filtration practice for extended periods of time. 	<ul style="list-style-type: none"> • Ensure that the filtration practice will drain completely within 36 hours of the end of a rainfall event to prevent the formation of nuisance ponding conditions.
<ul style="list-style-type: none"> • <i>Shallow water table</i> 	<ul style="list-style-type: none"> • May be difficult to provide 2 feet of clearance between the bottom of the filtration practice and the top of the water table. • May occasionally cause stormwater runoff to pond in the filtration practice. 	<ul style="list-style-type: none"> • Ensure that the distance from the bottom of the filtration practice to the top of the water table is at least 2 feet. • Use stormwater ponds (Section 8.6.1), stormwater wetlands (Section 8.6.2) and wet swales (Section 8.6.6), instead of bioretention areas to intercept and treat stormwater runoff in these areas.

Site Applicability

Filtration practices can be used to manage stormwater runoff on a wide variety of development sites. They are particularly well suited for intercepting and treating stormwater runoff from small, highly impervious areas (e.g., parking lots) on development sites where space for other stormwater management practices is limited. Filtration practices should primarily be considered for use on parts of commercial, industrial and institutional development sites where fine sediment (e.g., clay, silt) loads will be relatively low, as high sediment loads will cause them to clog and fail. When compared with other stormwater management practices, filtration practices have a relatively high construction cost, a relatively high maintenance burden and require a relatively small amount of surface area.

Planning and Design Criteria

It is *recommended* that filtration practices meet all of the planning and design criteria provided in Section 3.2.4 of Volume 2 of the *Georgia Stormwater Management Manual* (ARC, 2001) to be eligible for the stormwater management “credits” described above.

Construction Considerations

To help ensure that filtration practices are successfully installed on a development site, site planning and design teams should consider the following recommendations:

- To prevent practice failure due to sediment accumulation and pore clogging, filtration practices should only be installed after their contributing drainage areas have been completely stabilized. To help prevent practice failure, stormwater runoff may be diverted around the filtration practice until the contributing drainage area has become stabilized.
- Simple erosion and sediment control measures, such as temporary seeding and erosion control mats, should be used within any landscaped filtration practices (e.g., surface sand filters). Appropriate measures should be taken (e.g., temporary diversion) to divert post-construction stormwater runoff around a landscaped filtration practice until vegetative cover has been established.
- To help prevent soil compaction, heavy vehicular and foot traffic should be kept out of filtration practices during and after construction.
- Construction contracts should contain a replacement warranty that covers at least three growing seasons to help ensure adequate growth and survival of the vegetation planted within a landscaped filtration practice.

Maintenance Requirements

Maintenance is very important for filtration practices, particularly in terms of ensuring that they continue to provide measurable stormwater management benefits over time. Consequently, a legally binding inspection and maintenance agreement and plan should be created to help ensure that they are properly maintained after construction is complete. Table 8.15 provides a list of the routine maintenance activities typically associated with filtration practices.

Activity	Schedule
<ul style="list-style-type: none"> • Ensure that the contributing drainage area is stabilized prior to installation of the filtration practice. • If applicable, water to ensure plant growth and survival. • If applicable, inspect vegetative cover following rainfall events. Plant replacement vegetation in eroded areas. 	As Needed (During Construction)
<ul style="list-style-type: none"> • Inspect to ensure that contributing drainage area and filtration practice are clear of sediment, trash and debris. Remove any accumulated sediment and debris. • Ensure that the contributing drainage area is stabilized. Plant replacement vegetation as needed. • Check to ensure that the filtration practice is properly dewatering after storm events. • Ensure that activities in the contributing drainage area do not produce high sediment or oil and grease loads. • If a permanent water surface has been included in the design (e.g., perimeter sand filter), check to ensure that the filter chamber is not leaking and that the permanent water surface is maintained. 	Monthly

Table 8.15: Routine Maintenance Activities Typically Associated with Filtration Practices	
Activity	Schedule
<ul style="list-style-type: none"> Inspect for damage, paying particular attention to inlets, outlets and overflow spillways. Repair or replace any damaged components as needed. Check to see that the filter bed is free of sediment and that the sediment chamber is not more than 50% full of sediment. Remove accumulated sediment as necessary. If applicable, inspect filter chamber concrete for deterioration, spalling or cracking. Inspect inflow areas to ensure that stormwater runoff is not bypassing the filtration practice. Check for noticeable odors outside of the filter chamber. 	Annually
<ul style="list-style-type: none"> If filter bed is clogged or partially clogged, manual manipulation of the filter bed may be required. Remove the top 2 to 3 inches of the filter bed and till or otherwise cultivate the top of the filter bed. Replace the filter media with sand that meets the specifications provided above. Replace any clogged filter fabric. 	As Needed

It should be noted that sediments removed from filtration practices that do not receive stormwater runoff from stormwater hotspots are typically not considered to be toxic and can be safely disposed through either land application or landfilling. Check with the local development review authority to identify any additional constraints on the disposal of sediments removed from filtration practices.

Additional Resources

Atlanta Regional Commission (ARC). 2001. "Sand Filters." *Georgia Stormwater Management Manual*. Volume 2. Technical Handbook. Section 3.2.4. Atlanta Regional Commission. Atlanta, GA. Available Online: <http://www.georgia-stormwater.com/>.

Atlanta Regional Commission (ARC). 2001. "Organic Filters." *Georgia Stormwater Management Manual*. Volume 2. Technical Handbook. Section 3.3.3. Atlanta Regional Commission. Atlanta, GA. Available Online: <http://www.georgia-stormwater.com/>.

Atlanta Regional Commission (ARC). 2001. "Underground Sand Filters." *Georgia Stormwater Management Manual*. Volume 2. Technical Handbook. Section 3.3.4. Atlanta Regional Commission. Atlanta, GA. Available Online: <http://www.georgiastormwater.com/>.

THIS PAGE INTENTIONALLY LEFT BLANK

8.6.5 Infiltration Practices

Description

Infiltration practices, which may also be classified as a runoff reducing low impact development practice (Section 7.8.14), are shallow excavations, typically filled with stone or an engineered soil mix, that are designed to intercept and temporarily store post-construction stormwater runoff until it infiltrates into the underlying and surrounding soils. If properly designed, they can provide significant reductions in post-construction stormwater runoff rates, volumes and pollutant loads on development sites. Consequently, infiltration practices can be used to help satisfy the SWM Criteria presented in this CSS.



(Source: Center for Watershed Protection)

<p><u>KEY CONSIDERATIONS</u></p> <p>DESIGN CRITERIA:</p> <ul style="list-style-type: none"> • Pretreatment should be provided upstream of all infiltration practices • Infiltration practices should be designed to completely drain within 48 hours of the end of a rainfall event • Underlying native soils should have an infiltration rate of 0.5 in/hr or more • The distance from the bottom of an infiltration practice to the top of the water table should be 2 feet or more <p>BENEFITS:</p> <ul style="list-style-type: none"> • Helps restore pre-development hydrology on development sites and reduces post-construction stormwater runoff rates, volumes and pollutant loads • Can be integrated into development plans as attractive landscaping features <p>LIMITATIONS:</p> <ul style="list-style-type: none"> • Can only be used to manage runoff from relatively small drainage areas of 2-5 acres in size • Should not be used to “receive” stormwater runoff that contains high sediment loads 	<p><u>STORMWATER MANAGEMENT “CREDITS”</u></p> <ul style="list-style-type: none"> <input checked="" type="checkbox"/> Runoff Reduction <input checked="" type="checkbox"/> Water Quality Protection <input checked="" type="checkbox"/> Aquatic Resource Protection <input checked="" type="checkbox"/> Overbank Flood Protection <input checked="" type="checkbox"/> Extreme Flood Protection <p><input checked="" type="checkbox"/> = practice has been assigned quantifiable stormwater management “credit” that can be used to address this SWM Criteria</p>						
<p><u>SITE APPLICABILITY</u></p> <table border="0"> <tr> <td><input checked="" type="checkbox"/> Rural Use</td> <td><input type="checkbox"/> Construction Cost</td> </tr> <tr> <td><input checked="" type="checkbox"/> Suburban Use</td> <td><input type="checkbox"/> Maintenance</td> </tr> <tr> <td><input checked="" type="checkbox"/> Urban Use</td> <td><input type="checkbox"/> Area Required</td> </tr> </table>	<input checked="" type="checkbox"/> Rural Use	<input type="checkbox"/> Construction Cost	<input checked="" type="checkbox"/> Suburban Use	<input type="checkbox"/> Maintenance	<input checked="" type="checkbox"/> Urban Use	<input type="checkbox"/> Area Required	<p><u>STORMWATER MANAGEMENT PRACTICE PERFORMANCE</u></p> <p>Runoff Reduction 80% - Annual Runoff Volume Varies¹ - Runoff Reduction Volume</p> <p>Pollutant Removal² 80% - Total Suspended Solids 60% - Total Phosphorus 60% - Total Nitrogen N/A - Metals 80% - Pathogens</p> <p>1 = varies according to storage capacity of the infiltration practice 2 = expected annual pollutant load removal</p>
<input checked="" type="checkbox"/> Rural Use	<input type="checkbox"/> Construction Cost						
<input checked="" type="checkbox"/> Suburban Use	<input type="checkbox"/> Maintenance						
<input checked="" type="checkbox"/> Urban Use	<input type="checkbox"/> Area Required						

Discussion

Infiltration practices (Figure 8.24), which may also be classified as a runoff reducing low impact development practice (Section 7.8.14), are shallow excavations, typically filled with stone or an engineered soil mix, that are designed to intercept and temporarily store post-construction stormwater runoff until it infiltrates into the underlying and surrounding soils. If properly designed, they can provide significant reductions in post-construction stormwater runoff rates, volumes and pollutant loads on development sites.

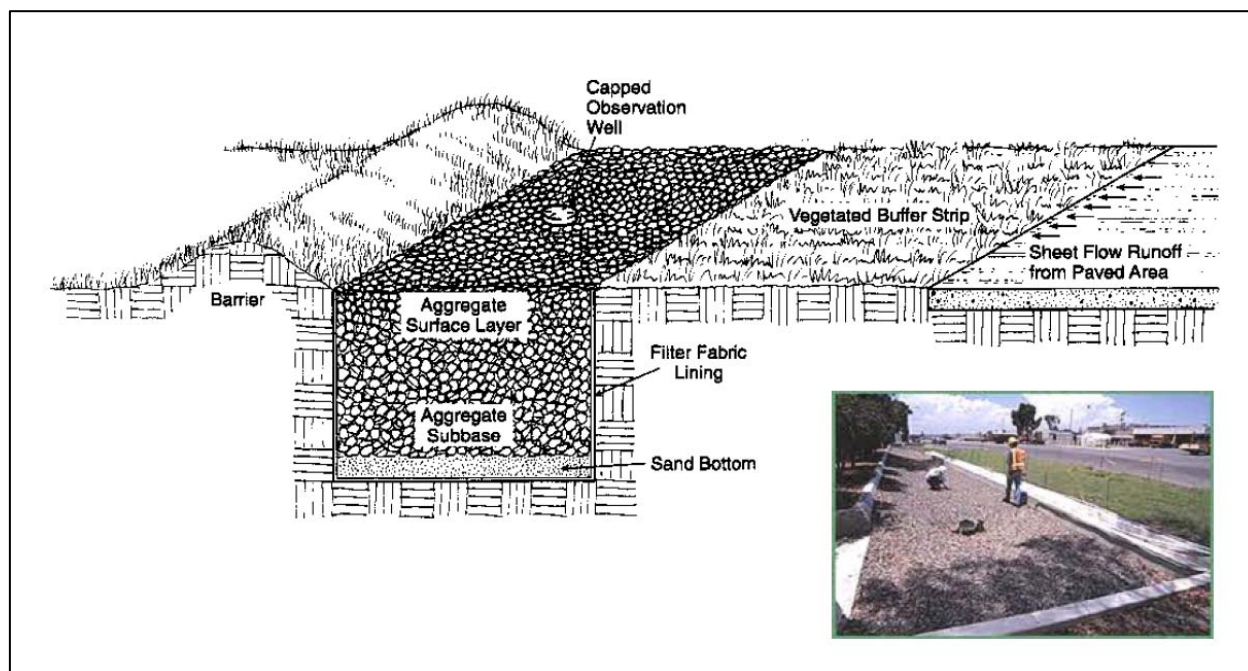

Figure 8.24: Infiltration Trench
(Source: Center for Watershed Protection)

Although infiltration practices can provide significant reductions in post-construction stormwater runoff rates, volumes and pollutant loads, they have historically experienced high rates of failure due to clogging caused by poor design, poor construction and neglected maintenance. If infiltration practices are to be used on a development site, great care should be taken to ensure that they are adequately designed, carefully installed and properly maintained over time. They should only be applied on development sites that have permeable soils (i.e., hydrologic soil group A and B soils) and that have a water table and confining layers (e.g., bedrock, clay lenses) that are located at least 2 feet below the bottom of the trench or basin. Additionally, infiltration practices should always be designed with adequate pretreatment (e.g., vegetated filter strip, sediment forebay) to prevent sediment from reaching them and causing them to clog and fail.

There are two major variations of infiltration practices, namely infiltration trenches and infiltration basins (Figure 8.25). A brief description of each of these design variants is provided below:

- **Infiltration Trenches:** Infiltration trenches are excavated trenches filled with stone (Figure 8.26). Stormwater runoff is captured and temporarily stored in the stone reservoir, where it is allowed to infiltrate into the surrounding and underlying native soils. Infiltration trenches can be used to manage post-construction stormwater runoff from contributing drainage areas of up to 2 acres in size and should only be used on development sites where sediment loads can be kept relatively low.

- **Infiltration Basins:** Infiltration basins are shallow, landscaped excavations filled with an engineered soil mix. They are designed to capture and temporarily store stormwater runoff in the engineered soil mix, where it is subjected to the hydrologic processes of evaporation and transpiration, before being allowed to infiltrate into the surrounding soils. They are essentially non-underdrained bioretention areas (Section 8.6.3), and should also only be used on development sites where sediment loads can be kept relatively low.



Figure 8.25: Infiltration Practices

Stormwater Management “Credits”

Infiltration practices have been assigned quantifiable stormwater management “credits” that can be used to help satisfy the SWM Criteria presented in this CSS:

- **Stormwater Runoff Reduction:** Subtract 100% of the storage volume provided by an *infiltration practice* from the runoff reduction volume (RR_v) conveyed through the *infiltration practice*.
- **Water Quality Protection:** Assume that an *infiltration practice* provides an 80% reduction in TSS loads, an 60% reduction in TN loads and an 80% reduction in bacteria loads.
- **Aquatic Resource Protection:** Although uncommon, on some development sites, an *infiltration practice* can be designed to provide 24-hours of extended detention for the aquatic resource protection volume (ARP_v).
- **Overbank Flood Protection:** Although relatively rare, on some development sites, an *infiltration practice* can be designed to attenuate the overbank peak discharge (Q_{p25}).
- **Extreme Flood Protection:** Although relatively rare, on some development sites, an *infiltration practice* can be designed to attenuate the extreme peak discharge (Q_{p100}).

The storage volume provided by an infiltration trench can be determined using the following equation:

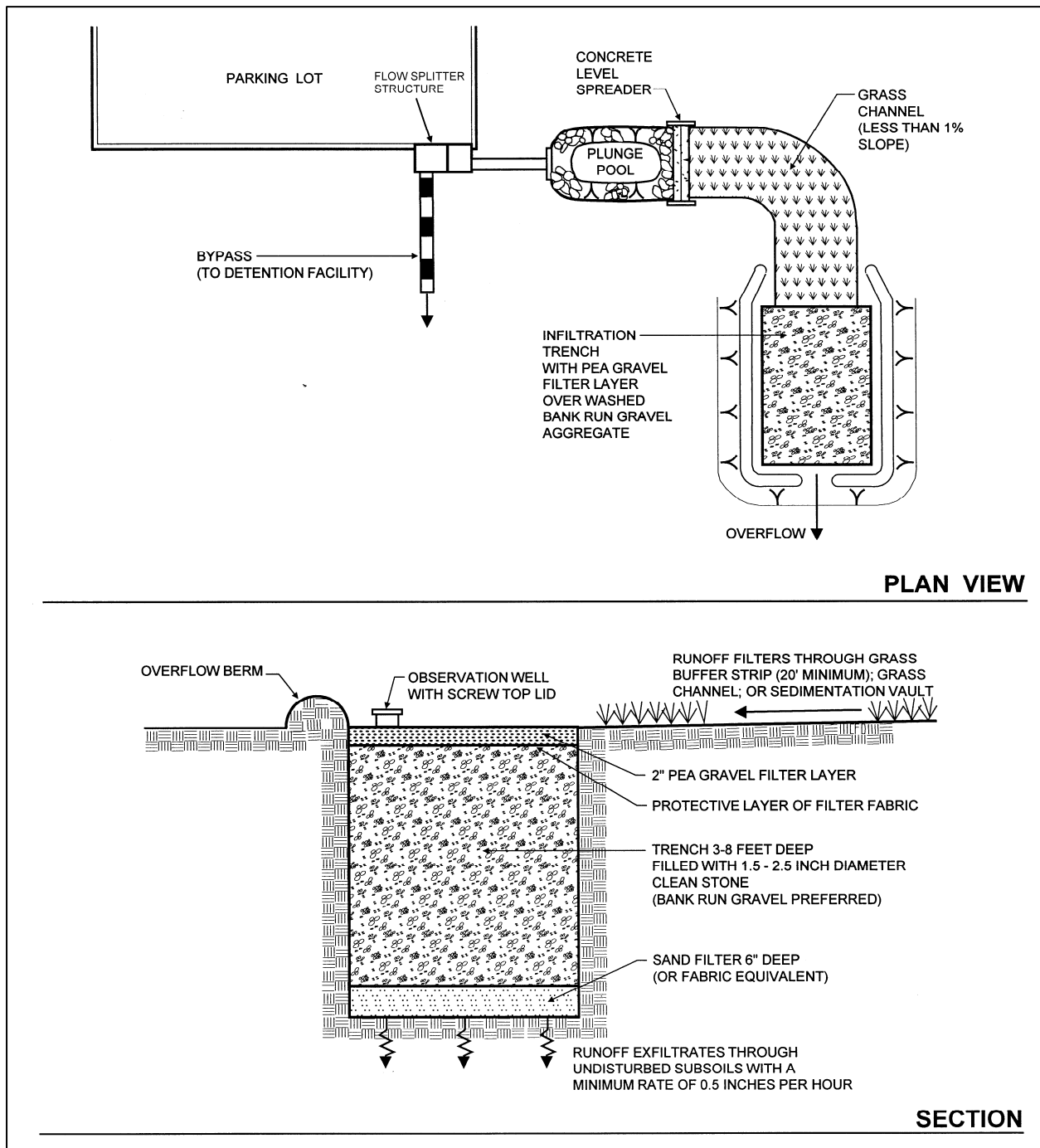

Figure 8.26: Schematic of a Typical Infiltration Trench
 (Source: Center for Watershed Protection)

$$\text{Storage Volume} = \text{Surface Area} \times \text{Depth} \times \text{Void Ratio}$$

A void ratio (i.e., void space/total volume) of 0.32 should be used in all storage volume calculations, unless more specific aggregate void ratio data are available.

The storage volume provided by an infiltration basin can be determined using the following equation:

$$\text{Storage Volume} = \text{Surface Area} \times [\text{Ponding Depth} + (\text{Depth of Planting Bed} \times \text{Void Ratio})]$$

A void ratio (i.e., void space/total volume) of 0.32 should be used in all storage volume calculations, unless more specific planting bed void ratio data are available.

In order to manage post-construction stormwater runoff and be eligible for these “credits,” it is *recommended* that infiltration practices satisfy the planning and design criteria outlined below.

Overall Feasibility

The criteria listed in Table 8.16 should be evaluated to determine whether or not an infiltration practice is appropriate for use on a development site.

Table 8.16: Factors to Consider When Evaluating the Overall Feasibility Of Using an Infiltration Practice on a Development Site	
Site Characteristic	Criteria
Drainage Area	Infiltration trenches can be used to manage stormwater runoff from contributing drainage areas up to 2 acres in size. Although infiltration basins can be used to manage stormwater runoff from contributing drainage areas as large as 5 acres in size, contributing drainage areas of between 2,500 square feet and 2 acres are preferred.
Area Required	Infiltration practice surface area requirements vary according to the size of the contributing drainage area and the infiltration rate of the soils on which the infiltration practice will be located. In general, infiltration practices require about 5% of the size of their contributing drainage areas.
Slope	Although infiltration practices may be used on development sites with slopes of up to 6%, they should be designed with slopes that are as close to flat as possible to help ensure that stormwater runoff is evenly distributed over the infiltration bed.
Minimum Head	Unless a shallow water table is found on the development site, all infiltration trenches should be designed to be at least 36 inches deep. Infiltration basins may be designed with a maximum ponding depth of 12 inches, although a ponding depth of 9 inches is recommended to help prevent the formation of nuisance ponding conditions. Unless a shallow water table is found on the development site, all infiltration basin planting beds should be at least 36 inches deep.
Minimum Depth to Water Table	2 feet
Soils	Infiltration practices should be designed to completely drain within 48 hours of the end of a rainfall event. Consequently, infiltration practices generally should not be used on development sites that have soils with infiltration rates of less than 0.25 inches per hour (i.e., hydrologic soil group C and D soils).

Feasibility in Coastal Georgia

Several site characteristics commonly encountered in coastal Georgia may present challenges to site planning and design teams that are interested in using infiltration practices to manage post-construction stormwater runoff on a development site. Table 8.17 identifies these common

site characteristics and describes how they influence the use of infiltration practices on development sites. The table also provides site planning and design teams with some ideas about how they can work around these potential constraints.

Site Characteristic	How it Influences the Use of Infiltration Practices	Potential Solutions
<ul style="list-style-type: none"> <i>Poorly drained soils, such as hydrologic soil group C and D soils</i> 	<ul style="list-style-type: none"> Reduces the ability of infiltration practices to reduce stormwater runoff rates, volumes and pollutant loads. 	<ul style="list-style-type: none"> Infiltration practices should not be used on development sites that have soils with infiltration rates of less than 0.25 inches per hour (i.e., hydrologic soil group C and D soils). Use other low impact development and stormwater management practices, such as rainwater harvesting (Section 7.8.12) and underdrained bioretention areas (Section 8.6.3), to manage post-construction stormwater runoff in these areas.
<ul style="list-style-type: none"> <i>Well drained soils, such as hydrologic soil group A and B soils</i> 	<ul style="list-style-type: none"> Enhances the ability of infiltration practices to reduce stormwater runoff rates, volumes and pollutant loads, but may allow stormwater pollutants to reach groundwater aquifers with greater ease. 	<ul style="list-style-type: none"> Avoid the use of infiltration-based stormwater management practices, including infiltration practices, at stormwater hotspots and in areas known to provide groundwater recharge to water supply aquifers, unless adequate pretreatment is provided upstream of them. Use bioretention areas (Section 8.6.3) and dry swales (Section 8.6.6) with liners and underdrains at stormwater hotspots and in areas known to provide groundwater recharge to water supply aquifers.
<ul style="list-style-type: none"> <i>Flat terrain</i> 	<ul style="list-style-type: none"> Does not influence the use of infiltration practices. In fact, infiltration practices should be designed with slopes that are as close to flat as possible. 	

Table 8.17: Challenges Associated with Using Infiltration Practices in Coastal Georgia		
Site Characteristic	How it Influences the Use of Infiltration Practices	Potential Solutions
<ul style="list-style-type: none"> • <i>Shallow water table</i> 	<ul style="list-style-type: none"> • May be difficult to provide 2 feet of clearance between the bottom of the infiltration practice and the top of the water table. • May occasionally cause stormwater runoff to pond in the bottom of the infiltration practice. 	<ul style="list-style-type: none"> • Ensure that the distance from the bottom of the infiltration practice to the top of the water table is at least 2 feet. • Reduce the depth of the stone reservoir in infiltration trenches to 18 inches. • Reduce the depth of the planting bed in infiltration basins to 18 inches. • Use stormwater ponds (Section 8.6.1), stormwater wetlands (Section 8.6.2) and wet swales (Section 8.6.6), instead of infiltration practices to intercept and treat stormwater runoff in these areas.
<ul style="list-style-type: none"> • <i>Tidally-influenced drainage system</i> 	<ul style="list-style-type: none"> • Does not influence the use of infiltration practices. 	

Site Applicability

Infiltration practices can be used to manage post-construction stormwater runoff on development sites in rural, suburban and urban areas where the soils are permeable enough and the water table is low enough to provide for the infiltration of stormwater runoff. While infiltration trenches are particularly well-suited for use on small, medium-to-high density development sites, infiltration basins can be used on larger, lower density development sites. Infiltration practices should only be considered for use on development sites where fine sediment (e.g., clay, silt) loads will be relatively low, as high sediment loads will cause them to clog and fail. In addition, infiltration practices should be carefully sited to avoid the potential contamination of water supply aquifers. When compared with other stormwater management practices, infiltration practices have a moderate construction cost, a moderate maintenance burden and require a relatively small amount of surface area.

Planning and Design Criteria

It is *recommended* that infiltration practices meet all of the following criteria to be eligible for the stormwater management “credits” described above:

General Planning and Design

- Infiltration trenches should be used to manage post-construction stormwater runoff from relatively small drainage areas of 2 acres or less. The stormwater runoff rates and volumes from larger contributing drainage areas typically become too large to be properly managed within an infiltration trench.
- Although infiltration basins can be used to manage post-construction stormwater runoff from contributing drainage areas as large as 5 acres in size, contributing drainage areas of between 2,500 square feet and 2 acres are preferred. Multiple infiltration basins can be used to manage stormwater runoff from larger contributing drainage areas.
- Although infiltration practices may be used on development sites with slopes of up to 6%, they should be designed with slopes that are as close to flat as possible to help ensure that stormwater runoff is evenly distributed over the stone reservoir or planting bed.

- Infiltration practices should be used on development sites that have underlying soils with an infiltration rate of 0.25 inches per hour (in/hr) or greater, as determined by NRCS soil survey data and subsequent field testing. Field infiltration test protocol, such as that provided by the City of Portland, OR (Portland, OR, 2008) on the following website: <http://www.portlandonline.com/shared/cfm/image.cfm?id= 202911>, can be used to conduct field testing, but should be approved by the local development review authority prior to use.
- Although the number of infiltration tests needed on a development site will ultimately be determined by the local development review authority, at least one infiltration test is recommended for each infiltration practice that will be used on the development site.
- Since clay lenses or any other restrictive layers located below the bottom of an infiltration practice will reduce soil infiltration rates, infiltration testing should be conducted within any confining layers that are found within 4 feet of the bottom of a proposed infiltration practice.
- Infiltration practices should be designed to provide enough storage for the stormwater runoff volume generated by the target runoff reduction rainfall event (e.g., 85th percentile rainfall event). The required dimensions of an infiltration practice that will be filled with stone (e.g., infiltration trench) can be determined using the following equation:

$$A_{in} = (RR_v) \div \{(n)(d_{in}) + [(i_{soil})(t_{fill}) \div 12]\}$$

Where:

A_{in} = surface area of infiltration trench (ft²)

RR_v = stormwater runoff volume generated by target runoff reduction rainfall event (ft³) (e.g., 85th percentile rainfall event)

n = porosity of fill media (use $n = 0.32$ for clean, washed stone specified below)

d_{in} = depth of stone reservoir (ft) (use 3 feet or more, unless a shallow water table is found on the development site)

i_{soil} = infiltration rate of underlying native soils (ft/day)

t_{fill} = average time for stone reservoir to fill (hour) (use $t_{fill} = 2$ hours)

The required dimensions of an infiltration practice that will be filled with an engineered soil mix (e.g., infiltration basin) can be determined using the following equation, which is based on Darcy's Law:

$$A_{bio} = (RR_v)(d_{bio}) \div [(k_{bio})(h_{bio} + d_{bio})(t_{drain})]$$

Where:

A_{bio} = surface area of infiltration basin (ft²)

RR_v = stormwater runoff volume generated by target runoff reduction rainfall event (ft³) (e.g., 85th percentile rainfall event)

d_{bio} = depth of infiltration basin planting bed (ft) (use 36 inches or more, unless a shallow water table is found on the development site)

k_{bio} = coefficient of permeability of infiltration basin planting bed (ft/day) (use $k_{bio} = 0.5$ ft/day for engineered soil mix specified below)

h_{bio} = average height of ponded water above infiltration basin (ft) (use 50% of maximum ponding depth)

t_{drain} = design infiltration basin drain time (days) (use 48 hours or less)

- Infiltration practices should be designed to completely drain within 48 hours of the end of a rainfall event. Where site characteristics allow, it is preferable to design infiltration

practices to drain within 24 hours of the end of a rainfall event to help prevent the formation of nuisance ponding conditions.

- Infiltration trenches should be located in a lawn or other pervious area and should be designed so that the top of the dry well is located as close to the surface as possible. Infiltration trenches should not be located beneath a driveway, parking lot or other impervious surface.
- Broader, shallower infiltration trenches perform more effectively by distributing stormwater runoff over a larger surface area. However, a minimum depth of 36 inches is recommended for all infiltration trench designs to prevent them from consuming a large amount of surface area on development sites. Whenever practical, the depth of infiltration trenches should be kept to 60 inches or less.
- Unless a shallow water table is found on the development site, all infiltration trenches should be designed to be at least 36 inches deep. If a shallow water table is found on the development site, the depth of the stone reservoir may be reduced to 18 inches.
- Infiltration trenches should be filled with clean, washed stone. The stone used in the infiltration trench should be 1.5 to 2.5 inches in diameter, with a void space of approximately 40% (e.g., GA DOT No. 3 Stone). Unwashed aggregate contaminated with soil or other fines may not be used in the trench.
- Underlying native soils should be separated from the stone reservoir by a thin, 2 to 4 inch layer of choker stone (i.e., ASTM D 448 size No. 8, 3/8" to 1/8" or ASTM D 448 size No. 89, 3/8" to 1/16"). The choker stone should be placed between the stone reservoir and the underlying native soils.
- The top and sides of the infiltration trench should be lined with a layer of appropriate permeable filter fabric. The filter fabric should be a non-woven geotextile with a permeability that is greater than or equal to the infiltration rate of the surrounding native soils. The top layer of the filter fabric should be located 6 inches from the top of the excavation, with the remaining space filled with pea gravel (i.e., ASTM D 448 Size No. 8, 3/8" to 1/8") or other appropriate landscaping. This top layer serves as a sediment barrier and, consequently, will need to be replaced over time. Site planning and design teams should ensure that the top layer of filter fabric can be readily separated from the filter fabric used to line the sides of the infiltration trench.
- Unless a shallow water table is found on the development site, all infiltration basin planting beds should be at least 36 inches deep. If a shallow water table is found on the development site, the depth of the planting bed may be reduced to 18 inches.
- The soils used within infiltration basin planting beds should be an engineered soil mix that meets the following specifications:
 - Texture: Sandy loam or loamy sand.
 - Sand Content: Soils should contain 85%-88% clean, washed sand.
 - Topsoil Content: Soils should contain 8%-12% topsoil.
 - Organic Matter Content: Soils should contain 3%-5% organic matter.
 - Infiltration Rate: Soils should have an infiltration rate of at least 0.25 inches per hour (in/hr), although an infiltration rate of between 1 and 2 in/hr is preferred.
 - Phosphorus Index (P-Index): Soils should have a P-Index of less than 30.
 - Exchange Capacity (CEC): Soils should have a CEC that exceeds 10 milliequivalents (meq) per 100 grams of dry weight.
 - pH: Soils should have a pH of 6-8.
- The organic matter used within an infiltration basin planting bed should be a well-aged compost that meets the specifications outlined in Section 7.8.1.
- Underlying native soils should be separated from the planting bed by a thin, 2 to 4 inch layer of choker stone (i.e., ASTM D 448 size No. 8, 3/8" to 1/8" or ASTM D 448 size No. 89, 3/8" to 1/16"). The choker stone should be placed between the planting bed and the underlying native soils.

- Infiltration practices should be preceded by a pea gravel (i.e., ASTM D 448 Size No. 8, 3/8" to 1/8") diaphragm or equivalent level spreader device (e.g., concrete sills, curb stops, curbs with "sawteeth" cut into them) and appropriate pretreatment device, such as a vegetated filter strip (Section 7.8.6) or sediment forebay.
- The depth from the bottom of an infiltration practice to the top of the water table should be at least 2 feet to help prevent ponding and ensure proper operation of the infiltration practice. On development sites with high water tables, small stormwater wetlands (i.e., pocket wetlands) (Section 8.6.2) should be used to intercept and treat post-construction stormwater runoff.
- To help prevent damage to building foundations and contamination of groundwater aquifers, infiltration practices should be located at least:
 - 10 feet from building foundations
 - 10 feet from property lines
 - 100 feet from private water supply wells
 - 1,200 feet from public water supply wells
 - 100 feet from septic systems
 - 100 feet from surface waters
 - 400 feet from public water supply surface waters
- An observation well should be installed in every infiltration practice. An observation well consists of a 4 to 6 inch perforated PVC (AASHTO M 252) pipe that extends to the bottom of the infiltration practice. The observation well can be used to observe the rate of drawdown within the infiltration practice following a storm event. It should be installed along the centerline of the infiltration practice, flush with the elevation of the surface of the infiltration practice. A visible floating marker should be provided within the observation well and the top of the well should be capped and locked to prevent tampering and vandalism. Appendix B in Volume 2 of the *Georgia Stormwater Management Manual* provides additional information about observation wells.
- Consideration should be given to the stormwater runoff rates and volumes generated by larger storm events (e.g., 25-year, 24-hour storm event) to help ensure that these larger storm events are able to safely bypass the infiltration practice. An overflow system should be designed to convey the stormwater runoff generated by these larger storm events safely out of the infiltration practice. Methods that can be used to accommodate the stormwater runoff rates and volumes generated by these larger storm events include:
 - Using storm drain inlets set slightly above the elevation of the surface of an infiltration trench to collect excess stormwater runoff. This will create some ponding on the surface of the infiltration trench, but can be used to safely convey excess stormwater runoff off of the surface of the trench.
 - Using yard drains or storm drain inlets set at the maximum ponding depth of an infiltration basin to collect excess stormwater runoff.
 - Using a spillway with an invert set slightly above the elevation of maximum ponding depth to convey the stormwater runoff generated by larger storm events safely out of an infiltration basin.
 - Placing a perforated pipe (e.g., underdrain) near the top of the stone reservoir or planting bed to provide additional conveyance of stormwater runoff after the infiltration trench or basin has been filled.

Landscaping

- The landscaped area above the surface of an infiltration trench may be covered with pea gravel (i.e., ASTM D 448 size No. 8, 3/8" to 1/8"). This pea gravel layer provides sediment removal and additional pretreatment upstream of the infiltration trench and can be easily removed and replaced when it becomes clogged.

- Alternatively, an infiltration trench may be covered with an engineered soil mix, such as that prescribed for use in infiltration basins, and planted with managed turf or other herbaceous vegetation. This may be an attractive option when infiltration trenches are placed in disturbed pervious areas (e.g., lawns, parks, community open spaces).
- A landscaping plan should be prepared for all infiltration basins. The landscaping plan should be reviewed and approved by the local development review authority prior to construction.
- Vegetation commonly planted in infiltration basins includes native trees, shrubs and other herbaceous vegetation. When developing a landscaping plan, site planning and design teams should choose vegetation that will be able to stabilize soils and tolerate the stormwater runoff rates and volumes that will pass through the infiltration basin. Vegetation used in infiltration basins should also be able to tolerate both wet and dry conditions. See Appendix F of Volume 2 of the *Georgia Stormwater Management Manual* (ARC, 2001) for a list of grasses and other plants that are appropriate for use in infiltration basins installed in the state of Georgia.
- A mulch layer, consisting of 2-4 inches of fine shredded hardwood mulch or shredded hardwood chips, should be included on the surface of an infiltration basin.
- Methods used to establish vegetative cover within an infiltration basin should achieve at least 75 percent vegetative cover one year after installation.
- To help prevent soil erosion and sediment loss, landscaping should be provided immediately after an infiltration basin has been installed. Temporary irrigation may be needed to quickly establish vegetative cover within an infiltration basin.

Construction Considerations

To help ensure that infiltration practices are successfully installed on a development site, site planning and design teams should consider the following recommendations:

- To prevent practice failure due to sediment accumulation and pore clogging, infiltration practices should only be installed after their contributing drainage areas have been completely stabilized. To help prevent infiltration practice failure, stormwater runoff may be diverted around the infiltration practice until the contributing drainage area has become stabilized.
- Simple erosion and sediment control measures, such as temporary seeding and erosion control mats, should be used within any landscaped infiltration practices. Appropriate measures should be taken (e.g., temporary diversion) to divert post-construction stormwater runoff around a landscaped infiltration practice until vegetative cover has been established.
- To help prevent soil compaction, heavy vehicular and foot traffic should be kept out of infiltration practices before, during and after construction. This can typically be accomplished by clearly delineating infiltration practices on all development plans and, if necessary, protecting them with temporary construction fencing.
- Excavation for infiltration practices should be limited to the width and depth specified in the development plans. Excavated material should be placed away from the excavation so as not to jeopardize the stability of the side walls.
- The sides of all excavations should be trimmed of all large roots that will hamper the installation of the permeable filter fabric used to line the sides and top of an infiltration trench.
- The native soils along the bottom of an infiltration practice should be scarified or tilled to a depth of 3 to 4 inches prior to the placement of the choker stone and stone reservoir or engineered soil mix.

- Construction contracts should contain a replacement warranty that covers at least three growing seasons to help ensure adequate growth and survival of the vegetation planted within a landscaped infiltration practice.

Maintenance Requirements

Maintenance is very important for infiltration practices, particularly in terms of ensuring that they continue to provide measurable stormwater management benefits over time. Consequently, a legally binding inspection and maintenance agreement and plan should be created to help ensure that they are properly maintained after construction is complete. Table 8.18 provides a list of the routine maintenance activities typically associated with infiltration practices.

Activity	Schedule
<ul style="list-style-type: none"> • Ensure that the contributing drainage area is stabilized prior to installation of the infiltration practice. • If applicable, water to promote plant growth and survival. • If applicable, inspect vegetative cover following rainfall events. Plant replacement vegetation in any eroded areas. 	As Needed (During Construction)
<ul style="list-style-type: none"> • Inspect to ensure that contributing drainage area and infiltration practice are clear of sediment, trash and debris. Remove any accumulated sediment and debris. • Ensure that the contributing drainage area is stabilized. Plant replacement vegetation as needed. • Check observation well to ensure that infiltration practice is properly dewatering after storm events. 	Monthly
<ul style="list-style-type: none"> • Inspect pretreatment devices for sediment accumulation. Remove accumulated sediment, trash and debris. • In infiltration trenches, inspect top layer of filter fabric and pea gravel or landscaping for sediment accumulation. Remove and replace if clogged. • Inspect infiltration practice for damage, paying particular attention to inlets, outlets and overflow spillways. Repair or replace any damaged components as needed. • Inspect infiltration practice following rainfall events. Check observation well to ensure that complete drawdown has occurred within 72 hours after the end of a rainfall event. Failure to drawdown within this timeframe may indicate infiltration practice failure. 	Annually (Semi-Annually During First Year)
<ul style="list-style-type: none"> • Perform total rehabilitation of the infiltration practice, removing stone or planting bed and excavating to expose clean soil on the sides and bottom of the practice. 	Upon Failure

Additional Resources

Atlanta Regional Commission (ARC). 2001. "Infiltration Trench." *Georgia Stormwater Management Manual*. Volume 2. Technical Handbook. Section 3.2.5. Atlanta Regional Commission. Atlanta, GA. Available Online: <http://www.georgia-stormwater.com/>.

Minnesota Pollution Control Agency (MPCA). 2006. "Infiltration Practices." *Minnesota Stormwater Manual*. Chapter 12. Minnesota Pollution Control Agency. Available Online: Available Online: <http://www.pca.state.mn.us/water/stormwater/stormwater-manual.html>.

THIS PAGE INTENTIONALLY LEFT BLANK

8.6.6 Swales

Description

Swales are vegetated open channels that are designed to manage post-construction stormwater runoff within wet or dry cells formed by check dams or other control structures (e.g., culverts). They are designed with relatively mild slopes to force stormwater runoff to flow through them slowly and at relatively shallow depths, which encourages sediment and other stormwater pollutants to settle out. Swales differ from grass channels (Section 7.8.7), in that they are designed with specific features that enhance their ability to manage stormwater runoff rates, volumes and pollutant loads on development sites.



(Source: Center for Watershed Protection)

<p style="text-align: center;"><u>KEY CONSIDERATIONS</u></p> <p>DESIGN CRITERIA:</p> <ul style="list-style-type: none"> • Maximum contributing drainage area of 5 acres or less • Swales should be designed to safely convey the overbank flood protection rainfall event (e.g., 25-year, 24-hour event) • Swales may be designed with a slope of between 0.5% and 4%, although a slope of between 1% and 2% is recommended • Swales should be designed to be between 2 and 8 feet wide to prevent channel braiding <p>BENEFITS:</p> <ul style="list-style-type: none"> • Provides moderate to high removal of many of the pollutants of concern typically contained in post-construction stormwater runoff • Less expensive than traditional drainage (e.g., curb and gutter, storm drain) systems <p>LIMITATIONS:</p> <ul style="list-style-type: none"> • Can only be used to manage runoff from relatively small drainage areas of 5 acres in size • Should not be used on development or redevelopment sites with slopes of less than 0.5% • Potential for nuisance ponding to occur in wet swales 	<p style="text-align: center;"><u>STORMWATER MANAGEMENT "CREDITS"</u></p> <ul style="list-style-type: none"> <input checked="" type="checkbox"/> Runoff Reduction <input checked="" type="checkbox"/> Water Quality Protection <input checked="" type="checkbox"/> Aquatic Resource Protection <input checked="" type="checkbox"/> Overbank Flood Protection <input checked="" type="checkbox"/> Extreme Flood Protection <p><input checked="" type="checkbox"/> = practice has been assigned quantifiable stormwater management "credits" that can be used to address this SWM Criteria</p>
<p style="text-align: center;"><u>SITE APPLICABILITY</u></p> <ul style="list-style-type: none"> <input checked="" type="checkbox"/> Rural Use <input checked="" type="checkbox"/> Suburban Use <input checked="" type="checkbox"/> * Urban Use <input type="checkbox"/> [M] Construction Cost <input type="checkbox"/> [M] Maintenance <input type="checkbox"/> [M] Area Required 	<p style="text-align: center;"><u>STORMWATER MANAGEMENT PRACTICE PERFORMANCE</u></p> <p>Runoff Reduction 0%¹/40%-80%² - Annual Runoff Volume 0%¹/Varies³ - Runoff Reduction Volume</p> <p>Pollutant Removal⁴ 80%¹/80%² - Total Suspended Solids 30%¹/50%² - Total Phosphorus 30%¹/50%² - Total Nitrogen 20%¹/40%²- Metals N/A - Pathogens</p> <p>1 = wet swale 2 = dry swale 3= varies according to storage capacity of the dry swale 4 = expected annual pollutant load removal</p>

Discussion

Swales (also known as *enhanced swales*, *vegetated open channels* or *water quality swales*) are vegetated open channels that are designed to manage post-construction stormwater runoff within wet or dry cells formed by check dams or other control structures (e.g., culverts). They are designed with relatively mild slopes to force stormwater runoff to flow through them slowly and at relatively shallow depths, which encourages sediment and other stormwater pollutants to settle out. Check dams and/or berms installed perpendicular to the flow path further promote settling and also encourage stormwater runoff to infiltrate into the underlying native soils. Swales differ from grass channels (Section 7.8.7), in that they are designed with specific features that enhance their ability to manage stormwater runoff rates, volumes and pollutant loads on development sites.

There are several variations of swales that can be used to manage post-construction stormwater runoff on development sites, the most common of which include dry swales and wet swales (Figure 8.27). A brief description of each of these design variants is provided below:

- **Dry Swales:** Dry swales (Figure 8.28) (also known as *bioswales*), which may also be classified as a low impact development practice (Section 7.8.15), are vegetated open channels that are filled with an engineered soil mix and are planted with trees, shrubs and other herbaceous vegetation. They are essentially linear bioretention areas (Section 8.6.3), in that they are designed to capture and temporarily store stormwater runoff in the engineered soil mix, where it is subjected to the hydrologic processes of evaporation and transpiration, before being conveyed back into the storm drain system through an underdrain or allowed to infiltrate into the surrounding soils. This allows them to provide measurable reductions in post-construction stormwater runoff rates, volumes and pollutant loads on development sites.
- **Wet Swales:** Wet swales (Figure 8.29) (also known as *wetland channels* or *linear stormwater wetlands*) are vegetated channels designed to retain water and maintain hydrologic conditions that support the growth of wetland vegetation. A high water table or poorly drained soils are necessary to maintain a permanent water surface within a wet swale. The wet swale essentially acts as a linear wetland treatment system, where the stormwater runoff volume generated by the target runoff reduction rainfall event (e.g., 85th percentile rainfall event) is intercepted and treated over time.

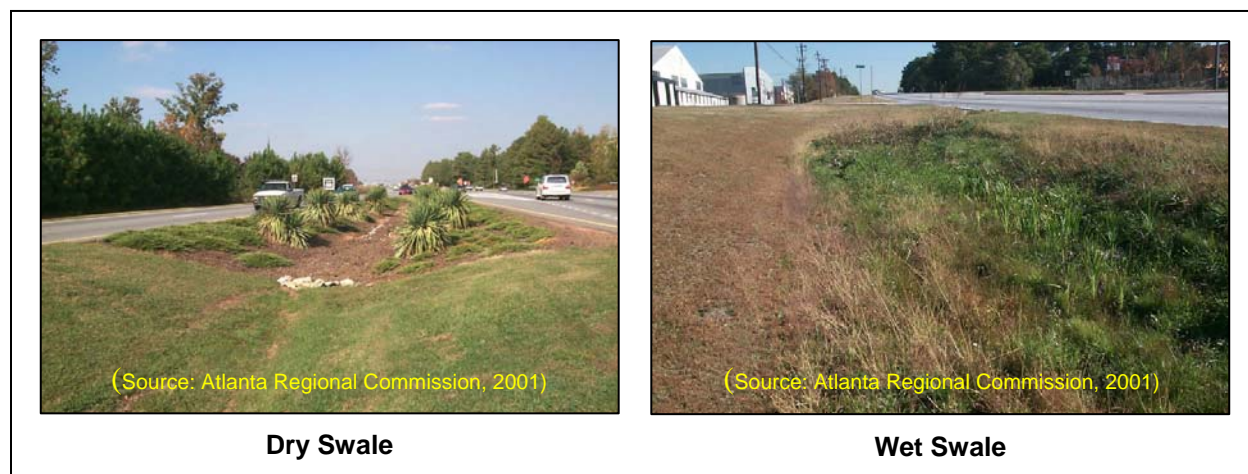

Figure 8.27: Various Swales

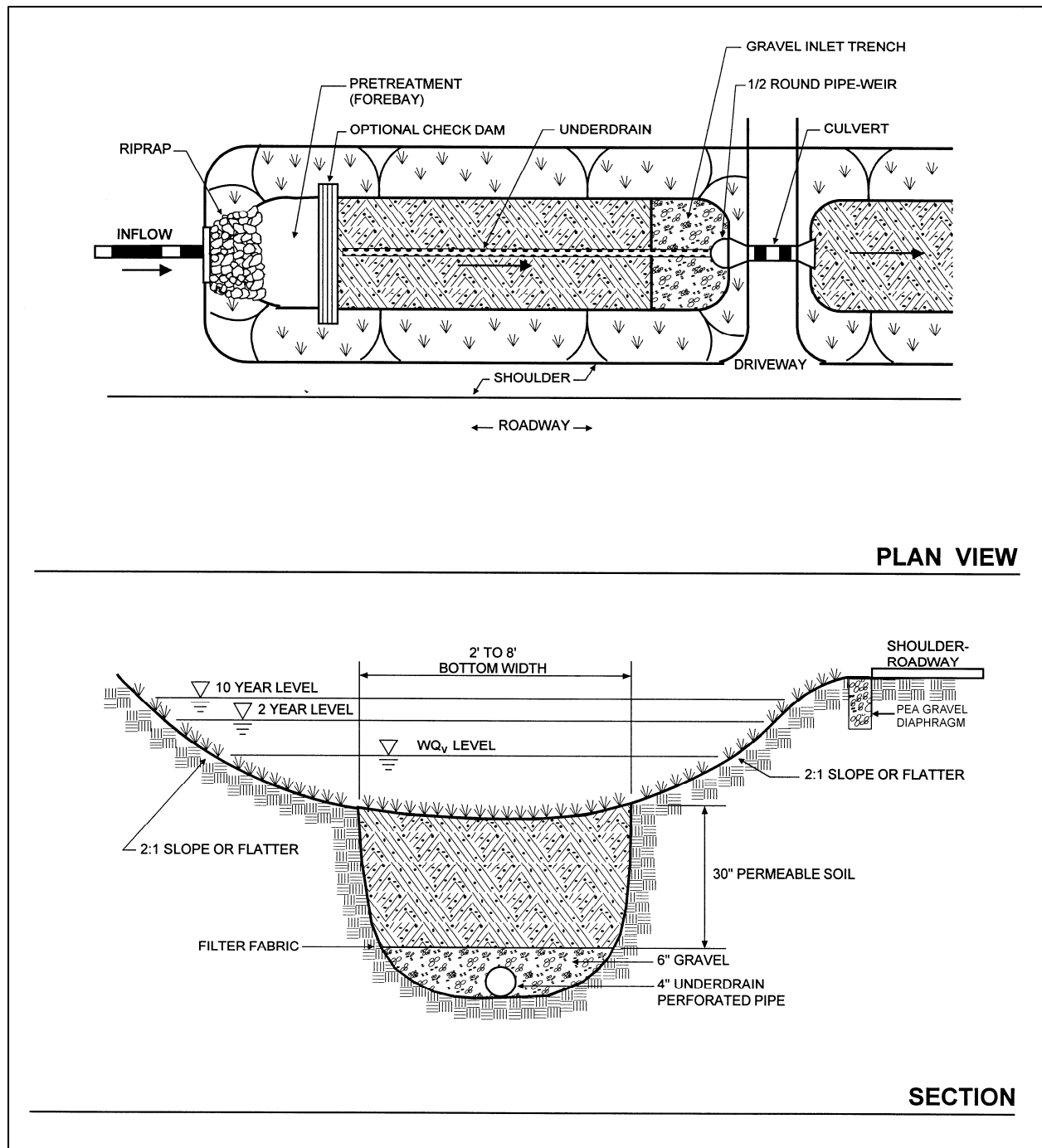

Figure 8.28: Schematic of a Typical Dry Swale
 (Source: Center for Watershed Protection)

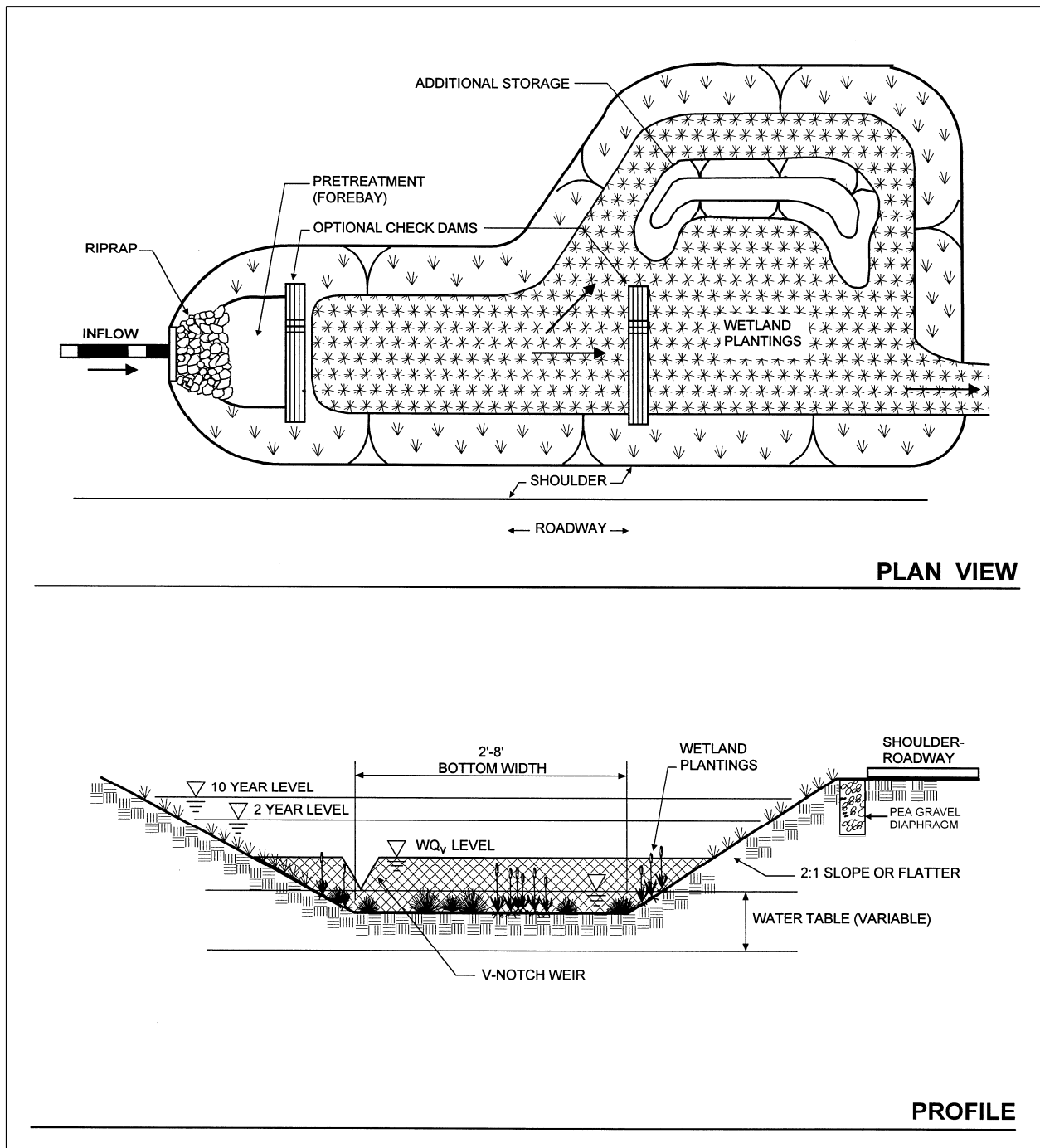

Figure 8.29: Schematic of a Typical Wet Swale
 (Source: Center for Watershed Protection)

Stormwater Management “Credits”

Swales have been assigned quantifiable stormwater management “credits” that can be used to help satisfy the SWM Criteria presented in this CSS:

- **Stormwater Runoff Reduction:** Subtract 100% of the storage volume provided by a non-underdrained *dry swale* from the runoff reduction volume (RR_v) conveyed through the *dry swale*. Subtract 50% of the storage volume provided by an underdrained *dry swale* from the runoff reduction volume (RR_v) conveyed through the *dry swale*.

Although *wet swales* provide moderate to high removal of many of the pollutants of concern typically contained in post-construction stormwater runoff, recent research shows that they provide little, if any, reduction of post-construction stormwater runoff volumes (Hirschman et al., 2008).

- **Water Quality Protection:** Assume that a *dry swale* provides an 80% reduction in TSS loads, a 50% reduction in TN loads and a 60% reduction in bacteria loads. Assume that a *wet swale* provides an 80% reduction in TSS loads, a 25% reduction in TN loads and a 40% reduction in bacteria loads.
- **Aquatic Resource Protection:** Although uncommon, on some development sites, a *wet or dry swale* can be designed to provide 24-hours of extended detention for the aquatic resource protection volume (ARP_v).
- **Overbank Flood Protection:** Although relatively rare, on some development sites, a *wet or dry swale* can be designed to attenuate the overbank peak discharge (Q_{p25}).
- **Extreme Flood Protection:** Although relatively rare, on some development sites, a *wet or dry swale* can be designed to attenuate the extreme peak discharge (Q_{p100}).

The storage volume provided by a dry swale can be determined using the following equation:

$$\text{Storage Volume} = \text{Surface Area} \times [\text{Ponding Depth} + (\text{Depth of Planting Bed} \times \text{Void Ratio})]$$

A void ratio (i.e., void space/total volume) of 0.32 should be used in all storage volume calculations, unless more specific planting bed void ratio data are available.

In order to manage post-construction stormwater runoff and be eligible for these “credits,” it is *recommended* that swales satisfy the planning and design criteria outlined below.

Overall Feasibility

The criteria listed in Table 8.19 should be evaluated to determine whether or not a dry swale is appropriate for use on a development site.

Table 8.19: Factors to Consider When Evaluating the Overall Feasibility of Using a Swale on a Development Site	
Site Characteristic	Criteria
Drainage Area	Wet and dry swales can be used to manage stormwater runoff from contributing drainage areas of up to 5 acres in size.

Table 8.19: Factors to Consider When Evaluating the Overall Feasibility of Using a Swale on a Development Site	
Site Characteristic	Criteria
Area Required	Wet and dry swale surface area requirements vary according to the size of the contributing drainage area and the infiltration rate of the soils on which the swale will be located. In general, dry swales require about 5-10% of the size of their contributing drainage areas. Wet swales typically require about 10-20% of their contributing drainage areas.
Slope	Although swales may be installed on development sites with slopes of between 0.5% and 4%, it is recommended that they be designed with slopes of between 1% and 2% to help ensure adequate drainage.
Minimum Head	1 to 2 feet for wet swales 3 to 4 feet for dry swales. Unless a shallow water table is found on the development site, all dry swale planting beds should be at least 30 inches deep.
Minimum Depth to Water Table	No restrictions for wet swales, although 2 feet of separation is recommended at stormwater hotspots and in areas known to provide groundwater recharge to water supply aquifers. 2 feet for dry swales
Soils	No restrictions for wet swales, although poorly drained soils (i.e., hydrologic soil group C or D soils) are usually adequate to maintain a permanent water surface in a wet pond. Wet swales constructed on development sites with permeable soils (i.e., hydrologic soil group A or B soils) may require a liner. Dry swales should be designed to completely drain within 48 hours of the end of a rainfall event. Consequently, non-underdrained dry swales generally should not be used on development sites that have soils with infiltration rates of less than 0.25 inches per hour (i.e., hydrologic soil group C and D soils). Underdrained dry swales may be used to manage stormwater runoff on development sites that have soils with infiltration rates of less than 0.25 inches per hour.

Feasibility in Coastal Georgia

Several site characteristics commonly encountered in coastal Georgia may present challenges to site planning and design teams that are interested in using swales to manage post-construction stormwater runoff on a development site. Table 8.20 identifies these common site characteristics and describes how they influence the use of swales on development sites. The table also provides site planning and design teams with some ideas about how they can work around these potential constraints.

Table 8.20: Challenges Associated with Using Swales in Coastal Georgia

Site Characteristic	How it Influences the Use of Swales	Potential Solutions
<ul style="list-style-type: none"> <i>Poorly drained soils, such as hydrologic soil group C and D soils</i> 	<ul style="list-style-type: none"> Since they are designed to have a permanent water surface, the presence of poorly drained soils does not influence the use of wet swales on development sites. In fact, the presence of poorly drained soils may help maintain a permanent water surface within a wet swale. Reduces the ability of dry swales to reduce stormwater runoff rates, volumes and pollutant loads. 	<ul style="list-style-type: none"> Use wet swales or underdrained dry swales to intercept, convey and treat post-construction stormwater runoff in these areas. Use additional low impact development and stormwater management practices, such as rainwater harvesting (Section 7.8.12) to supplement the stormwater management benefits provided by swales in these areas.
<ul style="list-style-type: none"> <i>Well drained soils, such as hydrologic soil group A and B soils</i> 	<ul style="list-style-type: none"> May be difficult to maintain a permanent water surface within a wet swale. Enhances the ability of dry swales to reduce stormwater runoff rates, volumes and pollutant loads. May allow stormwater pollutants to reach groundwater aquifers with greater ease. 	<ul style="list-style-type: none"> Avoid the use of infiltration-based stormwater management practices, including non-underdrained dry swales, at stormwater hotspots and in areas known to provide groundwater recharge to water supply aquifers, unless adequate pretreatment is provided upstream of them. Use dry swales and bioretention areas (Section 8.6.3) with liners and underdrains at stormwater hotspots and in areas known to provide groundwater recharge to water supply aquifers.
<ul style="list-style-type: none"> <i>Flat terrain</i> 	<ul style="list-style-type: none"> May be difficult to provide adequate drainage and may cause stormwater runoff to pond in the swale for extended periods of time. 	<ul style="list-style-type: none"> Design swales with a slope of at least 0.5% to help ensure adequate drainage. Where soils are well drained, use non-underdrained dry swales, non-underdrained bioretention areas (Section 8.6.3) and infiltration practices (Section 8.6.5), to reduce stormwater runoff rates, volumes and pollutant loads and prevent ponding in these areas. Ensure that the underlying native soils or underdrain system will allow a dry swale to drain completely within 48 hours of the end of a rainfall event to prevent the formation of nuisance ponding conditions.

Table 8.20: Challenges Associated with Using Swales in Coastal Georgia

Site Characteristic	How it Influences the Use of Swales	Potential Solutions
<ul style="list-style-type: none"> <i>Flat terrain</i> 	<ul style="list-style-type: none"> May be difficult to provide adequate drainage and may cause stormwater runoff to pond in the swale for extended periods of time. 	<ul style="list-style-type: none"> Where soils are poorly drained, use wet swales and small stormwater wetlands (i.e., pocket wetlands) (Section 8.6.2) to intercept and treat stormwater runoff.
<ul style="list-style-type: none"> <i>Shallow water table</i> 	<ul style="list-style-type: none"> May be difficult to provide 2 feet of clearance between the bottom of a dry swale and the top of the water table. May occasionally cause stormwater runoff to pond in a dry swale. 	<ul style="list-style-type: none"> Ensure that the distance from the bottom of a dry swale to the top of the water table is at least 2 feet. Reduce the depth of the planting bed in a dry swale to 18 inches. Use wet swales to intercept, convey and treat post-construction stormwater runoff in these areas.
<ul style="list-style-type: none"> <i>Tidally-influenced drainage system</i> 	<ul style="list-style-type: none"> May occasionally prevent stormwater runoff from being conveyed through a swale, particularly during high tide. 	<ul style="list-style-type: none"> Investigate the use of other low impact development practices, such as rainwater harvesting (Section 7.8.12) to manage post-construction stormwater runoff in these areas.

Site Applicability

Swales can be used to manage post-construction stormwater runoff on a wide variety of development sites, including residential, commercial and institutional development sites in rural, suburban and urban areas. They are well suited for use on residential and institutional development sites that have low to moderate development densities. They can be used to “receive” stormwater runoff from nearly all small impervious and pervious drainage areas, including local streets and roadways, highways, driveways, small parking areas and disturbed pervious areas (e.g., lawns, parks, community open spaces). When compared with other stormwater management practices, swales have a moderate construction cost, a moderate maintenance burden and require a moderate amount of surface area.

Planning and Design Criteria

It is *recommended* that swales meet all of the planning and design criteria provided in Section 3.2.6 of Volume 2 of the *Georgia Stormwater Management Manual* (ARC, 2001) to be eligible for the stormwater management “credits” described above.

Construction Considerations

To help ensure that swales are successfully installed on a development site, site planning and design teams should consider the following recommendations:

- To prevent practice failure due to sediment accumulation and pore clogging, swales should only be installed after their contributing drainage areas have been completely stabilized. To help prevent practice failure, stormwater runoff may be diverted around a swale until the contributing drainage area has become stabilized.

- Simple erosion and sediment control measures, such as temporary seeding and erosion control mats, should be used within all wet and dry swales. Appropriate measures should be taken (e.g., temporary diversion) to divert post-construction stormwater runoff around a swale until vegetative cover has been established.
- To help prevent soil compaction, heavy vehicular and foot traffic should be kept out of swales during and after construction.
- The native soils along the bottom of a dry swale should be scarified or tilled to a depth of 3 to 4 inches prior to the placement of the engineered soil mix.
- Construction contracts should contain a replacement warranty that covers at least three growing seasons to help ensure adequate growth and survival of the vegetation planted within a swale.

Maintenance Requirements

Maintenance is very important for swales, particularly in terms of ensuring that they continue to provide measurable stormwater management benefits over time. Consequently, a legally binding inspection and maintenance agreement and plan should be created to help ensure that they are properly maintained after construction is complete. Table 8.21 provides a list of the routine maintenance activities typically associated with swales.

Activity	Schedule
<ul style="list-style-type: none"> • Water to promote plant growth and survival. • Inspect swales following rainfall events. Plant replacement vegetation in any eroded areas. 	As Needed (Following Construction)
<ul style="list-style-type: none"> • Inspect to ensure that contributing drainage area and swale are clear of sediment, trash and debris. Remove any accumulated sediment and debris. • Ensure that the contributing drainage area is stabilized. Plant replacement vegetation as needed. • Check to ensure that dry swales are properly dewatering after storm events. 	Monthly
<ul style="list-style-type: none"> • If applicable, inspect pretreatment devices for sediment accumulation. Remove accumulated sediment, trash and debris. • Inspect swale for sediment accumulation. Remove sediment when it accounts for 25% or more of the original channel cross-section. • Inspect swale and side slopes for erosion and the formation of rills and gullies. Plant replacement vegetation in any eroded areas. • Inspect swale for dead or dying vegetation. Plant replacement vegetation as needed. 	Annually (Semi-Annually During First Year)
<ul style="list-style-type: none"> • If a dry swale filter bed is clogged or partially clogged, manual manipulation of the bed may be required. Remove the top 2 to 3 inches of the filter bed and till or otherwise cultivate the top of the bed. Replace the filter media with an appropriate engineered soil mix. 	As Needed

It should be noted that sediments removed from swales that do not receive stormwater runoff from stormwater hotspots are typically not considered to be toxic and can be safely disposed through either land application or landfilling. Check with the local development review authority to identify any additional constraints on the disposal of sediments removed from swales.

Additional Resources

Atlanta Regional Commission (ARC). 2001. "Enhanced Swales." *Georgia Stormwater Management Manual*. Volume 2. Technical Handbook. Section 3.2.6. Atlanta Regional Commission. Atlanta, GA. Available Online: <http://www.georgia stormwater.com/>.

8.7 Limited Application Stormwater Management Practice Profile Sheets

The reader is referred to Sections 3.3 and 3.4 of Volume 2 of the *Georgia Stormwater Management Manual* (ARC, 2001) for more information on the limited application stormwater management practices that can be used to manage post-construction stormwater runoff in coastal Georgia. The profile sheets describe each of the limited application stormwater management practices and discuss how to properly apply and design them on development sites. The limited application stormwater management practices profiled in Sections 3.3 and 3.4 of Volume 2 of the *Georgia Stormwater Management Manual* include:

Water Quantity Management Practices

- 3.4.1 Dry Detention Basins
- 3.4.1 Dry Extended Detention Basins
- 3.4.2 Multi-Purpose Detention Areas
- 3.4.3 Underground Detention Systems

Water Quality Management Practices

- 3.3.3 Organic Filters
- 3.3.4 Underground Filters
- 3.3.5 Submerged Gravel Wetlands
- 3.3.6 Gravity (Oil-Grit) Separators
- 3.3.9 Alum Treatment Systems
- 3.3.10 Proprietary Systems

Information about how each of these stormwater management practices can be used to help satisfy the SWM Criteria presented in this CSS is provided in Table 8.1.

THIS PAGE INTENTIONALLY LEFT BLANK

References

- Atlanta Regional Commission (ARC). 2001. *Georgia Stormwater Management Manual*. Volume 2. Technical Handbook. Atlanta Regional Commission. Atlanta, GA. Available Online: <http://www.georgiastormwater.com/>.
- City of Portland, OR. 2008. *Portland Stormwater Management Manual*. City of Portland, OR. Bureau of Environmental Services. Available Online: <http://www.portlandonline.com/bes/index.cfm?c=47952>.
- Fraley-McNeal, L., T. Schueler and R. Winer. 2007. *National Pollutant Removal Performance Database*. Version 3. Center for Watershed Protection. Ellicott City, MD. Available Online: http://www.cwp.org/Resource_Library/Center_Docs/SW/bmpwriteup_092007_v3.pdf.
- Hirschman, D., K. Collins and T. Schueler. 2008. *Runoff Reduction Method*. Center for Watershed Protection. Ellicott City, MD. Available Online: http://www.cwp.org/Resource_Library/Center_Docs/SW/RRTechMemo.pdf.
- Merrill, T.R., Coastal Georgia Regional Development Center (CGRDC) and EMC Engineering Services, Inc. 2006. *Green Growth Guidelines: A Low Impact Development Strategy for Coastal Georgia*. Prepared for: Georgia Department of Natural Resources (DNR) Coastal Management Program. Brunswick, GA. Available Online: <http://crd.dnr.state.ga.us/content/displaycontent.asp?txtDocument=969>.
- Strecker, E., M. Quigley, B. Urbonas and J. Jones. 2004. "Stormwater Management: State of the Art in Comprehensive Approaches to Stormwater". *The Water Report*. 6:1-10.
- Winer, R. 2000. *National Pollutant Removal Performance Database for Stormwater Treatment Practices*. 2nd Edition. Center for Watershed Protection. Ellicott City, MD. Available Online: http://www.cwp.org/Resource_Library/Center_Docs/SW/nprpdatabase.pdf.

THIS PAGE INTENTIONALLY LEFT BLANK

9.0 Local Post-Construction Stormwater Management Programs

9.1 Overview

Prior to the 1980s, stormwater management was synonymous with flood control. Post-construction stormwater management systems consisted primarily of pipes designed to convey stormwater runoff directly to rivers, streams and other aquatic resources. Flood control basins were occasionally installed to reduce peak discharge rates and alleviate localized and downstream flooding, but little thought was given to stormwater quality. Although this stormwater management approach worked well to reduce flooding and protect public safety, it did not address the wider range of negative impacts that land development can have on the health of rivers, streams and other aquatic resources.

During the 1980s, communities began to realize that, in order to better protect aquatic resources from the negative impacts of the land development process, both stormwater quantity *and* stormwater quality had to be addressed. With the introduction of Phase I of the National Pollutant Discharge Elimination System (NPDES) Stormwater Program in 1990, and Phase II of the NPDES Stormwater Program in 1999, communities began to revise and expand their local stormwater management programs. The programs that these communities developed focused on *managing* stormwater quantity and quality and tended to rely heavily on traditional stormwater management practices, such as wet and dry ponds, to *mitigate*, rather than *prevent*, the negative impacts of the land development process.

Since then, a number of communities around the country have concluded that “an ounce of prevention is worth a pound of cure.” They have been working to shift the focus away from the *mitigation* of the negative impacts of the land development process and place it on their *prevention*, by creating post-construction stormwater management programs that successfully integrate stormwater management and natural resource protection with the site planning and design process. These communities are increasingly using their stormwater management programs to protect and/or restore valuable natural resources, create attractive public and private spaces and engage residents and businesses in environmental stewardship.

Picking up on this national trend, this Section provides information that can be used to shift the focus of local post-construction stormwater management programs onto the *prevention*, rather than the *mitigation*, of the negative impacts of the land development process. Georgia’s coastal communities should find it to be a valuable resource in their efforts to develop local post-construction stormwater management programs that are consistent with the integrated, green infrastructure-based approach to natural resource protection, stormwater management and site design presented in this Coastal Stormwater Supplement (CSS).

9.2 Developing an Effective Local Post-Construction Stormwater Management Program

In order to better protect coastal Georgia’s aquatic and terrestrial resources from the negative impacts of the land development process, communities located within the 24-county coastal region need to develop post-construction stormwater management programs that effectively *integrate* natural resource protection and stormwater management with the site planning and design process. In order to accomplish this, communities should consider the following questions when developing (or improving) their programs:

- What are some of the local natural resource protection and stormwater management goals?

- What valuable terrestrial and aquatic resources can be found within and around the community?
- What negative impacts can the land development process have on these valuable natural resources?
- What kind of approach to post-construction stormwater management can be used to effectively balance land development and economic growth with the protection of these valuable natural resources?
- What stormwater management and site planning and design criteria are needed to support the selected approach?
- How can local land use planning and zoning efforts be linked with the selected approach and how can they be used to protect valuable natural resources from the negative impacts of the land development process?
- What codes and ordinances (e.g., stormwater management ordinance) are needed to provide a sound legal foundation for the selected approach?
- What kind of additional information (e.g., stormwater guidance manual) needs to be provided to support the selected approach?
- How can the community's existing plan review and approval process be used to verify compliance with the selected stormwater management and site planning and design criteria?
- What type of inspection program is needed to verify that green infrastructure and stormwater management practices are properly installed during construction?
- What type of inspection and maintenance program is needed to help ensure that green infrastructure and stormwater management practices will continue to function as designed over time?
- What type of tracking system is needed to evaluate the effectiveness of the local post-construction stormwater management program over time?

Although answering these questions is no easy task (i.e., answering these questions typically requires a thorough understanding of the existing local post-construction stormwater management program), answers to all of these questions can be readily obtained within the context of the eight-step *stormwater management program development process* illustrated in Figure 9.1 and outlined below:

- Step 1: Program Planning
 - Step 1.1: Assess Community and Its Watersheds
 - Step 1.2: Assess Existing Stormwater Management Program
 - Step 1.3: Develop Program Goals and Objectives
 - Step 1.4: Develop Implementation Plan and Program Budget
- Step 2: Develop Stormwater Management Approach
 - Step 2.1: Develop an Approach to Address Stormwater Management at the Site Scale
 - Step 2.2: Develop Supporting Stormwater Management and Site Planning & Design Criteria
 - Step 2.3: Develop an Approach to Address Stormwater Management at the Watershed Scale
- Step 3: Develop Post-Construction Stormwater Management Ordinance
- Step 4: Develop Stormwater Guidance Manual
- Step 5: Develop Plan Review and Approval Process
 - Step 5.1: Scope Out Plan Review and Approval Process
 - Step 5.2: Create Permit Applications, Instructions and Checklists
 - Step 5.3: Forecast Staff Needs and Acquire Plan Review Staff
 - Step 5.4: Provide Training for Plan Reviewers and Site Designers

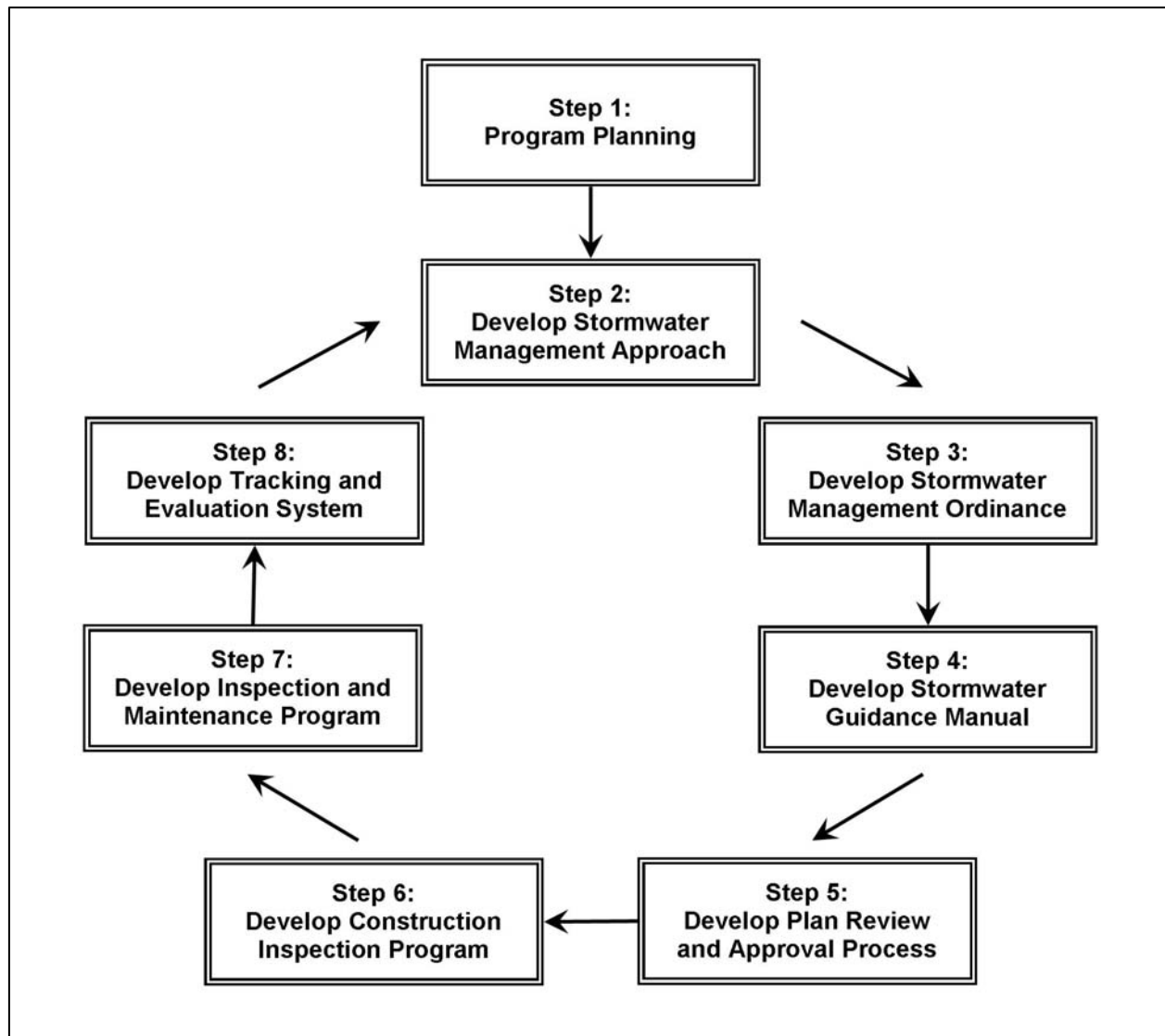

Figure 9.1: Post-Construction Stormwater Management Program Process Development Process

(Source: Center for Watershed Protection)

- Step 5.5: Set Up Performance Bond Process, Forms and Tracking System
- Step 6: Develop Construction Inspection Program
 - Step 6.1: Scope Out the Inspection Process
 - Step 6.2: Create Checklists and As-Built Certification Forms
 - Step 6.3: Forecast Staff Needs and Acquire Inspection Staff
 - Step 6.4: Provide Training for Inspectors and Contractors
- Step 7: Develop Inspection and Maintenance Program
 - Step 7.1: Scoping the Inspection and Maintenance Program
 - Step 7.2: Create Checklists, Inspection Forms and Enforcement Tools
 - Step 7.3: Forecast Staff Needs and Acquire Inspection Staff
 - Step 7.4: Create and Disseminate Outreach Materials for Responsible Parties
- Step 8: Develop Program Tracking and Evaluation System
 - Step 8.1: Develop a Framework for Program Tracking and Evaluation
 - Step 8.2: Develop Program Tracking and Evaluation Protocols
 - Step 8.3: Write Annual Reports

Each step in this *stormwater management program development process* is described in more detail below.

9.3 Step 1: Program Planning

The first step in building an effective stormwater management program is to conduct some preliminary program planning. Each of the tasks involved in completing this part of the *stormwater management program development process* are described in more detail below.

9.3.1 Step 1.1: Assess Community and Its Watersheds

The first task is to collect some basic information about the community and its watersheds. This information will help identify current stormwater management problems, needs and regulatory requirements and will help communities make informed decisions during the development (or improvement) of their programs. Information that should be collected about the community and its watersheds includes geographic, demographic and water quality information, as described below.

Geographic Information

A community's planning, engineering or public works department will likely be able to provide the maps and other geographic information that are needed to develop an effective stormwater management program. For example, soil and floodplain maps can be used to identify areas where new development is most appropriate and to identify areas where it should be avoided. Key geographic information to collect includes:

- Maps
 - Watersheds
 - Floodplains
 - Soils
 - Land use
 - Land cover
 - Aquatic resources (e.g., rivers and streams, wetlands, coastal marshlands)
 - Terrestrial resources (e.g., maritime forests, marsh hammocks, pine flatwoods)
 - Roads
 - Existing stormwater infrastructure
- Precipitation data
- Areas prone to flooding

Demographic Information

It is important for a community to understand its demographic information in order to identify where development has occurred in the past and where it is likely to occur in the future. When developing a stormwater management program, a community should consider how future development will interact with both aquatic and terrestrial resources. For instance, will new development consist primarily of residential development located on the urban fringe or will it consist of redevelopment located closer to the urban core? Key demographic information to collect during the program planning phase includes:

- Current population
- Anticipated population growth
- Current land use and zoning

- Proposed land use and zoning changes
- Proposed construction projects (e.g., number, type)
- Build out analysis showing full development potential under existing zoning
- Transportation and infrastructure plans

Water Quality Information

Water quality data can be used to help identify local pollutants of concern and impaired water bodies. Communities should design their local post-construction stormwater management programs to address these pollutants of concern and to help protect any impaired aquatic resources. While this information may be less readily available than the geographic or demographic data described above, it is still very important to the development of an effective stormwater management program. Key water quality information to collect includes:

- Water quality sampling data
- Location of water quality monitoring stations
- Existing water quality criteria and designated use information
- Existing 303(d) impairments
- Existing TMDLs
- Areas of local concern (e.g., eroded channels, water quality problem areas)
- Information about groundwater resources (e.g., location of public wells, source water protection areas, groundwater recharge areas)
- Location of other local aquatic resources in need of protection (e.g., high value streams, freshwater wetlands, tidal creeks, shellfish harvesting areas)

All of the basic geographic, demographic and water quality information described above can be used to complete a simple assessment of a community and its watersheds. Additional information may need to be collected to complete a more thorough assessment of local conditions.

9.3.2 Step 1.2: Assess Existing Stormwater Management Program

After collecting some basic information about the community and its watersheds, the next step is to assess the community's existing post-construction stormwater management program. This "self-assessment", which will help a community identify gaps and determine what improvements need to be made, can be completed by answering some basic questions about a community's existing stormwater management program:

- What valuable terrestrial and aquatic resources can be found within and around the community?
- What negative impacts can the land development process have on these valuable natural resources?
- Is the community's existing post-construction stormwater management program adequately protecting these terrestrial and aquatic resources from the negative impacts of the land development process?
- What state and/or federal regulations apply to the community's post-construction stormwater management program?
- Are these state and/or federal regulations adequately addressed by the community's existing post-construction stormwater management program?
- Does the community have a comprehensive set of post-construction stormwater management and site planning and design criteria that support the existing post-construction stormwater management program?

- How are local land use planning and zoning efforts used to protect local natural resources from the negative impacts of the land development process?
- Do local land use planning and zoning efforts complement or counteract the community's existing post-construction stormwater management program?
- What mechanism (e.g., ordinance) is used to provide a legal foundation for the existing post-construction stormwater management program?
- Does the ordinance (or other legal mechanism) need to be updated to better support the community's approach to post-construction stormwater management?
- Does the community provide any technical guidance and support (e.g., stormwater guidance manual) on its existing post-construction stormwater management program?
- Does the community consider post-construction stormwater management in its existing site plan review and approval process?
- What tools are in place (e.g., permit applications, instructions, checklists) to assist local design consultants and plan reviewers with the community's existing site plan review and approval process?
- Are green infrastructure and stormwater management practices inspected during construction to ensure that they are being properly installed?
- Are green infrastructure and stormwater management practices regularly inspected and maintained after installation to ensure that they continued to function as designed over time?
- What enforcement procedures are in place to ensure that any observed maintenance deficiencies get corrected?
- How is the effectiveness of the local stormwater management program evaluated over time?

The questions provided above can be used to conduct a basic "self-assessment" of a local post-construction stormwater management program. Information about conducting a more detailed assessment of an existing stormwater management program is provided in *Managing Stormwater in Your Community: A Guide for Building an Effective Post-Construction Program* (Hirschman and Kosco, 2008).

9.3.3 Step 1.3: Develop Program Goals and Objectives

After collecting some basic information about the community and its watersheds, the next step is to use the information to develop some goals and objectives that will help guide the rest of the *stormwater management program development process*. Additional information about developing stormwater management program goals and objectives is provided below.

Define Program Goals

All stormwater management program goals should take into account local natural resource protection and stormwater management goals and any applicable state and/or federal stormwater management regulations. Potential stormwater management program goals include:

- Satisfy state and/or federal regulatory requirements
- Reduce the impacts of the land development process on local aquatic and terrestrial resources
- Protect and/or enhance the habitat value of local aquatic and terrestrial resources
- Maintain pre-development hydrology
- Protect and/or improve water quality
- Minimize flood risk and property damage

- Protect public health and safety
- Ensure a functional drainage system
- Protect floodplains
- Protect drinking water supplies
- Inform local land use planning and zoning efforts
- Support infill and redevelopment projects

Often, a consensus building approach, with input from elected officials and the general public, can be used to help define local stormwater management program goals. Communities will often develop multiple goals to help guide the development of their local post-construction stormwater management programs.

Develop Program Objectives

Once some stormwater management program goals have been defined, information obtained from the program “self-assessment” should be used to develop more specific, measurable objectives that can be used to evaluate progress in working toward each goal. For instance, a community may have selected the protection of water quality as one of its stormwater management program goals. Measurable objectives related to this goal might include:

- Maintaining the designated uses of streams and other aquatic resources found within and around the community
- Implementing a water quality monitoring program
- Establishing a post-construction stormwater management criteria that addresses water quality protection

With these objectives in place, specific action items and program elements can begin to be developed.

9.3.4 Step 1.4: Develop Implementation Plan and Preliminary Budget

Once a community has defined some program goals and objectives, the next step in the process is to determine what needs to be done to meet those goals and objectives and how much it will cost to do so. Each of these tasks is described in more detail below.

Develop Implementation Plan

An implementation plan outlines all of the tasks that need to be completed to satisfy a program’s goals and objectives. While this may appear to be a daunting task, implementation plans can be readily prepared using a logical, step-wise approach that involves:

- Developing action items for each program objective
- Developing a phased implementation plan for each of the action items

Additional information about completing each of these tasks is provided below.

Information gathered during the community’s “self-assessment” can be used to develop action items for each program objective. For instance, a community may have decided that it is not doing enough to protect local water quality and the health of local rivers and streams. Consequently, it may have selected establishing a post-construction stormwater management criteria that addresses water quality protection as one of its program objectives. Action items related to this objective might include:

- Conducting research on the water quality protection criteria used by other communities
- Reviewing and revising the existing post-construction stormwater management ordinance to include water quality protection
- Holding public meetings to gather input on the proposed revisions

Action items will vary from community to community, depending to the status of the community's existing post-construction stormwater management program and the specific program goals and objectives that it has selected. Some potential action items are provided in Table 9.1.

Program Objective	Action Items
<ul style="list-style-type: none"> • Develop a stormwater management approach that better addresses water quality protection 	<ul style="list-style-type: none"> • Craft or revise stormwater management approach to address water quality protection • Develop or revise supporting stormwater management and site planning & design criteria • Develop or revise existing post-construction stormwater management ordinance
<ul style="list-style-type: none"> • Develop a stormwater management approach that better addresses the preservation of pre-development site hydrology 	<ul style="list-style-type: none"> • Craft or revise stormwater management approach to address the preservation of pre-development site hydrology • Develop or revise supporting stormwater management and site planning & design criteria • Develop or revise existing post-construction stormwater management ordinance
<ul style="list-style-type: none"> • Ensure that local land use planning and zoning efforts complement, rather than counteract, the goals and objectives of the program 	<ul style="list-style-type: none"> • Link existing program with local land use planning and zoning efforts • Evaluate the local comprehensive plan to ensure that it is consistent with the community's site-scale approach to stormwater management • Examine local development rules to ensure that they are consistent with the community's site-scale approach to stormwater management
<ul style="list-style-type: none"> • Ensure that stormwater management is adequately addressed during the plan review and approval process 	<ul style="list-style-type: none"> • Create and/or review and revise plan review and approval process • Coordinate plan review and approval process with appropriate state and federal agencies
<ul style="list-style-type: none"> • Provide better technical guidance and support for the existing program 	<ul style="list-style-type: none"> • Develop or adapt a stormwater guidance manual • Develop or adapt permit applications, instructions and checklists to support existing plan review and approval process
<ul style="list-style-type: none"> • Ensure that all green infrastructure and stormwater management practices are properly installed during construction 	<ul style="list-style-type: none"> • Develop program to inspect green infrastructure and stormwater management practices during construction • Require submittal of as-built plans at end of construction phase • Provide training to local contractors on the proper installation of green infrastructure and stormwater management practices

Program Objective	Action Items
<ul style="list-style-type: none"> Ensure that all green infrastructure and stormwater management practices continue to function as designed over time 	<ul style="list-style-type: none"> Develop and/or review and revise inspection and maintenance program Develop system to track inspection results and maintenance activities Develop database of people and/or parties that are responsible for inspecting and maintaining privately-owned stormwater management practices

It is not necessary, and usually not possible, for a community to pursue and complete all of its selected action items at the same time. Instead, a phased implementation plan that sets a reasonable schedule for completion of each of action item should be developed.

Create Program Budget

At this point in the process, a preliminary estimate of the costs associated with each of the action items should be developed. In addition, potential funding sources should be identified. Funding is essential to the success of a local post-construction stormwater management program and will be required to both develop the program and ensure the ongoing operation of the program. In terms of the long-term operation of a program, the key funding issues are: (1) how much will it cost, on an annual basis, to fund the program; and (2) how this funding can be provided.

In coastal Georgia, revenues from taxes currently serve as the main funding source for local post-construction stormwater management programs. However, a number of alternative funding methods exist, including bonds, impact fees, permit and plan review fees, special assessments, special service fees and user fees. Each funding source has its own advantages and limitations, and every community should explore the various funding options to put together a funding plan that will: (1) provide the necessary revenue; and (2) earn the support of local elected officials and the general public.

One particular source of funding that shows particular promise in coastal Georgia are stormwater user fees, also known as *stormwater utilities*. In fact, two recent state and regional planning initiatives support the development of stormwater utilities within the 24-county coastal region:

- Draft Coastal Comprehensive Plan: The Draft Coastal Comprehensive Plan recommends that local governments “develop stormwater utility programs across the region” to meet specific watershed management goals outlined in the Plan (DCA, 2008). In addition, the plan outlines performance standards for local governments to achieve “excellence standards” and one of those standards includes implementing a stormwater utility.
- Comprehensive Statewide Water Management Plan: Georgia’s Comprehensive Statewide Water Management Plan recommends that local governments set up and implement stormwater utilities to address non-point source pollution (EPD, 2008). The plan encourages the use of stormwater utilities as a mechanism for funding the administration, operations and maintenance and capital construction costs of local stormwater management programs and non-point source pollution controls.

While there can be administrative, political and legal hurdles to overcome during the development of a stormwater utility, once in place, a utility can become an excellent source of

consistent, dedicated funding for a local post-construction stormwater management program. Georgia's coastal communities can use the information presented in the *Stormwater Utility Handbook: A Step-by-Step Guide to Establishing a Utility in Coastal Georgia* (Carter, 2008) to begin the process of developing a stormwater utility.

9.4 Step 2: Develop a Stormwater Management Approach

Once the preliminary program planning step has been completed, the next step in the process of developing a local post-construction stormwater management is to develop a stormwater management approach that will best satisfy the program's chosen goals and objectives. Each of the tasks involved in completing this step are described in more detail below.

9.4.1 Step 2.1: Develop an Approach to Address Stormwater Management at the Site Scale

To better protect local natural resources from the negative impacts of land development and nonpoint source pollution, it is *recommended* that Georgia's coastal communities adopt the integrated, green infrastructure-based approach to natural resource protection, stormwater management and site design presented in this CSS. This site-scale approach, which has been designed to help balance land development and economic growth with the protection of aquatic and terrestrial resources, involves:

- Identifying the valuable natural resources found on development sites prior to the start of any land disturbing activities.
- Protecting these valuable natural resources from the direct impacts of the land development process through the use of better site planning techniques.
- Limiting land disturbance and the amount of impervious and disturbed pervious cover created on development sites through the use of better site design techniques.
- *Reducing* post-construction stormwater runoff rates, volumes and pollutant loads, through the use of better site planning and design techniques and low impact development practices, to help:
 - Maintain pre-development site hydrology
 - Prevent downstream water quality degradation
 - Prevent downstream flooding and erosion
- *Managing* post-construction stormwater runoff rates, volumes and pollutant loads, through the use of stormwater management practices, to help:
 - Prevent downstream water quality degradation
 - Prevent downstream flooding and erosion

If successfully integrated into local post-construction stormwater management efforts, this integrated approach to natural resource protection, stormwater management and site design will lead to better protection of the aquatic and terrestrial resources that contribute so greatly to the region's natural beauty, economic well-being and quality of life.

9.4.2 Step 2.2: Develop Supporting Stormwater Management and Site Planning & Design Criteria

The next step in the process is to translate the selected approach into some supporting stormwater management and site planning and design criteria. These criteria will provide a foundation for the chosen stormwater management approach, and will establish how the site planning and design process will be carried out within the community.

It is *recommended* that Georgia's coastal communities adopt the post-construction stormwater management and site planning and design criteria presented in this CSS. They have been designed to support the integrated, green infrastructure-based approach to natural resource protection, stormwater management and site design that is detailed within the document. The criteria have also been designed to help communities comply with the requirements of various state and federal environmental policies, programs and regulations, including the NPDES Municipal Stormwater Program and Section 6217 of the Coastal Zone Act Reauthorization Amendments of 1990 (CZARA). Communities may adapt the criteria "as-is" or may review and modify them to meet more specific local natural resource protection and stormwater management goals and objectives.

9.4.3 Step 2.3: Develop an Approach to Address Stormwater Management at the Watershed Scale

The integrated approach to natural resource protection, stormwater management and site design presented in this CSS is applied at the site scale. While integrating natural resource protection and stormwater management with the site planning and design process helps protect valuable aquatic and terrestrial resources from the negative impacts of the land development process, local natural resource protection and stormwater management goals can be more rapidly achieved by simultaneously addressing this topic at the watershed scale as well.

Addressing stormwater management at the watershed scale involves integrating natural resource protection and stormwater management goals with broader land use planning and zoning efforts. This can be accomplished by completing three basic tasks:

- Linking local post-construction stormwater management and land use planning and zoning efforts
- Evaluating the local comprehensive plan to ensure that it is consistent with the community's site-scale approach to stormwater management
- Examining local development rules to ensure that they are consistent with the community's site-scale approach to stormwater management

Each of these tasks is described in more detail below.

Linking Local Stormwater Management and Land Use Planning and Zoning Efforts

To more rapidly achieve local natural resource protection and stormwater management goals and objectives, communities need to establish a link between their post-construction stormwater management programs and their land use planning and zoning efforts. By making this link, communities can use their land use planning and zoning efforts as the "first stormwater BMP," and can work to protect and conserve the valuable aquatic and terrestrial resources found within and around the community.

When working at the watershed scale, the need for additional natural resource protection and stormwater management techniques and practices becomes clear. For instance, while better site planning techniques, which are applied at the site scale, can be used to protect and conserve valuable natural resources on a development site, they cannot be used to direct growth away from these important aquatic and terrestrial resources. And while better site design techniques, which are also applied at the site scale, can be used to minimize the creation of new impervious cover on a development site, they cannot be used to move this new impervious cover away from sensitive aquatic and terrestrial resources, such as shellfish harvesting areas

and marsh hammocks. Only by using environmentally-sensitive land use planning and zoning strategies, such as the creation of overlay zoning categories, special use districts and infill and redevelopment zones, can a community move beyond the site scale and more effectively address both natural resource protection and stormwater management.

Evaluating the Local Comprehensive Plan

Consistency between the local post-construction stormwater management program and the local comprehensive plan is very important. Local comprehensive plans can have a significant impact on local development patterns, which in turn, can have a significant impact on local aquatic and terrestrial resources. Consequently, a community's comprehensive plan should be evaluated to ensure that it complements, rather than counteracts, local natural resource protection and stormwater management efforts.

Examining Local Development Rules

A community often has many different "development rules" that regulate the site planning and design process. For instance:

- Local street design standards may require the use of certain street and sidewalk widths on a development site
- Local plumbing codes may require that downspouts be directly connected to the storm drain system
- Local zoning ordinances may require large building setbacks that restrict the use of better site design techniques on a development site

Many communities across the country have found that these and other "development rules" (e.g., subdivision ordinances, zoning ordinances, parking lot and street design standards) have prevented developers from encouraging an integrated, green infrastructure-based approach to natural resource protection, stormwater management and site design. These communities have found that their own codes and ordinances are responsible for the wide streets, expansive parking lots and large lot subdivisions that are crowding out the very natural resources that they are trying to protect (CWP, 1998). Obviously, it is difficult for a community to adopt an integrated, green infrastructure-based approach to natural resource protection, stormwater management and site design when its own local "development rules" restricts its use.

Consequently, a community should review and revise its "development rules" to ensure that they complement, rather than counteract, its local natural resource protection and stormwater management efforts. Impediments to the use of an integrated, green infrastructure-based approach to natural resource protection, stormwater management and site design may be found in all of these "development rules":

- Zoning Ordinance
- Subdivision Codes
- Subarea or District Master Plans
- Street Standards or Road Design Manual
- Parking Requirements
- Building and Fire Regulations/Standards
- Stormwater Management or Drainage Criteria
- Buffer or Floodplain Regulations
- Environmental Regulations
- Tree Protection or Landscaping Ordinance

- Erosion and Sediment Control Ordinances
- Public Fire Defense Master plans
- Grading Ordinance

Detailed guidance on reviewing and revising a community's "development rules" is provided in *Better Site Design: A Handbook for Changing Development Rules in Your Community* (CWP, 1998).

9.5 Step 3: Develop Post-Construction Stormwater Management Ordinance

Once a stormwater management approach has been decided upon, and some supporting stormwater management and site planning and design criteria have been crafted, the next step in the *stormwater management program development process* is to develop a post-construction stormwater management ordinance. While many of Georgia's coastal communities may already have "development rules" that address post-construction stormwater management (e.g., drainage ordinance, flood control ordinance), these rules may not fully support an integrated approach to natural resource protection, stormwater management and site design (Table 9.2). Therefore, it is *recommended* that communities use the model post-construction stormwater ordinance presented in Appendix D to update and revise their existing stormwater management regulations. Communities may adopt the model ordinance "as-is" or may review and modify it to meet more specific local natural resource protection and stormwater management goals and objectives.

Table 9.2: Common Inconsistencies Between Existing Development Rules and the Approach to Stormwater Management Presented in this Coastal Stormwater Supplement

Existing Development Rules	Common Inconsistencies
Existing Drainage and Stormwater Management Codes and Ordinances	<ul style="list-style-type: none"> • Existing drainage ordinances may stress collection and conveyance of stormwater runoff, rather than on-site stormwater management • Existing stormwater management ordinances may be out-of-date and may only address flood control (instead of water quality, stormwater runoff reduction, etc.) • Existing stormwater management ordinances may not allow the use of low impact development practices (e.g., stormwater planters, rain gardens, rain barrels) on development sites • Existing stormwater management ordinances may not provide adequate "credit" for the use of green infrastructure practices, such as better site planning and design techniques (e.g., site restoration and reforestation, disconnection of impervious cover, protection of primary and secondary conservation areas) and low impact development practices (e.g., stormwater planters, rain gardens, rain barrels) on development sites

9.6 Step 4: Develop Stormwater Guidance Manual

Although they provide a foundation for a community's chosen stormwater management approach, and establish how the site planning and design process will be carried out within the community, a community's stormwater management and site planning and design criteria are typically only addressed in a cursory fashion within the local post-construction stormwater

management ordinance. Additional information about these criteria, and the green infrastructure and stormwater management practices that can be used to meet them, should be provided in a stormwater guidance manual to ensure that the community's chosen stormwater management approach is effectively implemented on the ground.

Ultimately, the information contained within a stormwater guidance manual influences:

- How well natural resource protection and post-construction stormwater management will be integrated with the site planning and design process
- How green infrastructure and stormwater management practices will be used to address the local post-construction stormwater management and site planning and design criteria
- The types of green infrastructure practices that will be used on new development and redevelopment sites and whether they will be encouraged or required
- The types of stormwater management practices, such as wet ponds and wetlands, that will be used on new development and redevelopment sites
- The size, function, performance and appearance of both green infrastructure and traditional stormwater management practices
- How easily green infrastructure and stormwater management practices can be accessed for maintenance and the frequency and type of maintenance that they require

It takes a significant amount of effort to create a stormwater guidance manual. Fortunately, Georgia's coastal communities do not have to undertake this daunting task. Instead, they can simply reference this CSS, particularly if they have adopted the integrated, green infrastructure-based approach to natural resource protection, stormwater management and site design that is detailed within. It provides valuable information about the supporting stormwater management and site planning and design criteria and about the green infrastructure and stormwater management practices that can be used to meet them. Communities are encouraged to review and modify the contents of this CSS, as necessary, to meet more specific local watershed and stormwater management goals and objectives.

9.7 Step 5: Develop a Plan Review and Approval Process

The next step in the *stormwater management program development process* is to develop a plan review and approval process that can be used to verify compliance with the community's post-construction stormwater management and site planning and design criteria.

The plan review and approval process is much more important than it may first appear. After development plans are approved, construction equipment starts rolling and land disturbing activities, such as clearing and grading, begin. At this point, making changes to development plans can be very time consuming and difficult to achieve. Consequently, the plan review and approval process is the best opportunity to get things right with regards to natural resource protection and stormwater management. A well-organized plan review and approval process is a tremendous asset to a local post-construction stormwater management program and can help ensure that:

- Green infrastructure and stormwater management practices satisfy a community's site planning and design and post-construction stormwater management criteria and are properly applied on development sites

- Post-construction stormwater management systems make use of green infrastructure practices, such as environmentally-sensitive site planning and design techniques and small-scale, low impact development practices
- Green infrastructure and stormwater management practices are located within easements and have adequate access for inspection and maintenance
- Maintenance agreements that assign long-term maintenance responsibility for green infrastructure and stormwater management practices are in place
- Local review and approval of development plans is coordinated with state and/or federal review and approval of development plans for erosion and sediment control, streams, wetlands, floodplains and dams
- Information about green infrastructure and stormwater management practices is provided so that inspection and maintenance staff will have the information needed to complete follow-up inspections

While reviewing green infrastructure and stormwater management practices during the plan review and approval process may be a relatively new concept for a community, many of Georgia's coastal communities already have a plan review and approval process in place. Some of the biggest challenges to integrating the stormwater management review process with existing plan review and approval processes include: (1) securing adequate and well-trained staff; and (2) conducting stormwater management reviews concurrent with other plan reviews for drainage, utilities, erosion control, roads and site layout.

Each of the tasks involved in developing an effective plan review and approval process is described in more detail below.

9.7.1 Step 5.1: Scope Out Plan Review and Approval Process

The *recommended* plan review and approval process includes the following steps:

1. Pre-application meeting
2. Submittal and review of stormwater concept plan
3. Consultation meeting
4. Submittal and review of stormwater design plan

These steps help create a plan review and approval process that complements the *integrated* approach to natural resource protection, stormwater management and site design detailed in this CSS. This allows the site designer and the plan reviewer to work together to meet local natural resource protection and stormwater management goals, rather than turning the plan review and approval process into a contentious endeavor. While setting up a site plan review and approval process, it is also important to consider issues like integrating stormwater management reviews with other plan reviews for drainage, utilities, erosion control, roads and site layout, balancing staff time between plan reviews and site inspections and involving the public in the review process.

9.7.2 Step 5.2: Create Permit Applications, Instructions and Checklists

In a community's plan review and approval process, the main customers will be the applicants who will be submitting development plans for review and approval. A smooth plan review process relies on providing clear instructions to both developers and site planning and design teams. While often overlooked, completing this task, by providing application forms and instructions that indicate exactly what information needs to be submitted for review, has the potential to significantly improve a community's plan review and approval process. When site

design information is presented in a consistent, organized manner, plan review and approval becomes much easier for local plan review staff.

9.7.3 Step 5.3: Forecast Staff Needs and Acquire Plan Review Staff

Proper staffing is an essential element of any successful plan review and approval process. If the stormwater management portion of the plan review and approval process will be significantly different or more time-intensive than any other elements of the existing plan review and approval process, additional plan review staff may need to be acquired. Plan reviewers that will be reviewing post-construction stormwater management plans should have experience in civil or environmental engineering, be knowledgeable about a community's stormwater management approach and its supporting site planning and design and stormwater management criteria and be qualified to review every element of a stormwater management design plan.

9.7.4 Step 5.4: Provide Training for Plan Reviewers and Site Designers

Once the local plan review and approval process has been developed and is ready to be implemented, it is important to provide training to the local plan reviewers and site planning and design teams that will be involved with the process. Without adequate training, the quality of submitted stormwater management plans will be lower, and the time needed to complete each review will be greater. This will increase the overall number of submittals needed to get a single project through the process, which will result in an increased financial burden being placed on the local development community as well as on the local post-construction stormwater management program.

9.7.5 Step 5.5: Set Up Performance Bond Process, Forms and Tracking System

Performance bonds are financial tools used to guarantee that any construction that affects the public interest is performed in an appropriate manner and in accordance with the terms and conditions of applicable local codes and ordinances. In a typical stormwater management performance bond, a developer or property owner guarantees that construction of post-construction stormwater practices will be completed in accordance with the approved stormwater management design plan. Should the developer or property owner fail to initiate or complete construction of the post-construction stormwater practices according to the terms of the approved plan, the performance bond ensures that enforcement action can be taken by the jurisdiction at the developer's or property owner's expense.

There are a number of important things to consider when developing a local performance bond process, including:

- Process for establishing the total required dollar amount of the bond and security (e.g., percentage of total estimated construction cost)
- Responsibility for determining the required dollar amount of the bond and security (e.g., jurisdiction, site developer/owner)
- Allowable forms of bond security (e.g., surety bond, letter of credit)
- Required duration of the bond and the process under which it will be released
- General procedures for ordinance enforcement, including issuing notices of violation and levying penalties
- Conditions under which the bond will be enforced (e.g., will bond be enforced as a penalty?)
- Responsibilities of surety when surety bonds are submitted as security

- Bond tracking system for community

Many aspects of the performance bond process involve complex contract and legal issues. Therefore, it is *recommended* that a community interested in developing a local performance bond program enlist the help of a qualified attorney. Additional information about developing a local performance bond program, including a bond estimating tool, is provided in *Managing Stormwater in Your Community: A Guide for Building an Effective Post-Construction Program* (Hirschman and Kosco, 2008).

9.8 Step 6: Develop Construction Inspection Program

The next step in the *stormwater management program development process* is to establish an inspection program that can be used to ensure that green infrastructure and stormwater management practices are properly installed during construction. While many of Georgia's coastal communities currently conduct site inspections during the construction phase of a development project, many of these inspections are not comprehensive enough to ensure that green infrastructure and stormwater management practices are being properly installed.

Many green infrastructure and stormwater management practice failures can be attributed to improper installation. An inspection program that thoroughly inspects these practices during construction can be used to prevent many of these problems from occurring in the first place. An effective construction inspection process can also help ensure that:

- Low impact development and stormwater management practices are built according to specifications and as shown on approved stormwater management plans
- Better site planning and design techniques are properly implemented on development sites
- Proper materials and construction techniques are used to install green infrastructure and stormwater management practices

Each of the tasks involved in developing an effective construction inspection program is described in more detail below.

9.8.1 Step 6.1: Scope Out the Inspection Process

The first task that needs to be completed when developing a local construction inspection program is to scope out the inspection process. A list of scoping questions is provided below to assist communities in completing this task:

- Does the community already inspect development sites during construction?
- What level of integration is desired and/or possible between a stormwater-focused inspection program and other existing construction inspection programs?
- What is the current level of knowledge among inspectors about the design and installation of green infrastructure and stormwater management practices?
- How often will green infrastructure and stormwater management practices on active construction sites need to be inspected?
- How many staff will be needed to inspect green infrastructure and stormwater management practices on active construction sites?
- Is there an existing tracking system for inspections and enforcement actions that can be modified to include the inspection of green infrastructure and stormwater management practices during construction?

The answers to these questions will help a community identify the action items that will need to be completed to develop an effective construction inspection program. Ultimately, a community's construction inspection program should include:

- Pre-construction meetings to verify the project schedule and to ensure that contractors and inspectors understand each other's expectations
- Routine inspections to observe progress
- Inspections of green infrastructure and stormwater management practices at critical milestones (e.g., it is much easier to inspect an underdrain in a bioretention area before it has been covered with soil than after it has been covered)
- Confirmation of as-builts as a final check to see that all green infrastructure and stormwater management practices were properly installed

9.8.2 Step 6.2: Create Checklists and As-Built Certification Forms

As with the plan review process, a smooth construction inspection process relies on providing reliable information to local developers, site designers and plan reviewers. There are a number of components that need to be inspected on every development site during construction to ensure that green infrastructure and stormwater management practices are being properly installed. These inspection items should be recorded on checklists and outlined in the educational materials that are provided to the development community. This will help formalize the inspection process and set clear expectations for everyone that is involved with it. When this information is presented in a consistent, organized manner, construction site inspection becomes much easier for local inspection staff. It also becomes easier to track inspection results and trigger enforcement actions as they become necessary.

Additional information about developing checklists for your local construction inspection program, including example construction inspection checklists, is provided in *Managing Stormwater in Your Community: A Guide for Building an Effective Post-Construction Program* (Hirschman and Kosco, 2008).

9.8.3 Step 6.3: Forecast Staff Needs and Acquire Inspection Staff

Staff trained in the proper installation and maintenance of green infrastructure and stormwater management practices will be needed to ensure that these practices are installed correctly on development sites. These inspectors can be inspectors from other municipal departments (e.g., building or erosion and sediment control inspectors), stormwater plan reviewers, specialized stormwater inspectors or private consultants. Some of the pros and cons associated with each of these options are presented below:

- Existing employees from other departments provide the advantage of efficient staff utilization, but it is possible that stormwater inspections will not get the attention they deserve
- Stormwater plan reviewers are likely to be most familiar with green infrastructure and stormwater management specifications, but inspection can be time-consuming, and using plan reviewers could delay the plan review and approval process if there are many inspections to conduct
- Specialized stormwater inspection staff may be the best choice for ensuring proper green infrastructure and stormwater management practice installation, but depending upon the number and type of development projects occurring within a community, having specialized stormwater inspection staff can consume a lot of financial resources

- Use of private consultants can free up stormwater staff for other activities, but they generally do not have enforcement authority; this option also places an additional financial burden on the community

Every one of Georgia's coastal communities should explore the various options and select an approach that will best meet its own needs and budgetary constraints.

9.8.4 Step 6.4: Provide Training for Inspectors and Contractors

Construction inspectors must possess the skills necessary to identify conditions that could affect green infrastructure or stormwater management practice installation or hinder long-term performance. To help ensure that the local inspection staff has the skills that it needs, a community should develop and implement a training program (or take advantage of a training program at the regional or state level) that addresses the following elements:

- Construction site sequencing
- Design and function of green infrastructure and stormwater management practices
- Material specifications
- Green infrastructure and stormwater management practice installation techniques and sequencing
- Confined space training, especially in communities where underground stormwater management practices will be used
- Unique issues with proprietary devices
- Common pitfalls in construction that affect the function of green infrastructure and stormwater management practices
- Inspection protocols/process, both for contractors and agency staff
- Enforcement response plan and tools

Training and certification for contractors is also important. This helps to ensure that contractors are installing and inspecting green infrastructure and stormwater management practices appropriately and ensures that they are better able to communicate with local inspection staff when problems are observed on site.

9.9 Step 7: Develop Inspection and Maintenance Program

A great deal of effort has been put into getting to this point in the *stormwater management program development process*. Crafting an approach to post-construction stormwater management, adopting a stormwater management ordinance and developing (or referencing) a stormwater guidance manual are significant milestones. Getting green infrastructure and stormwater management practices included on site plans and getting them installed properly on development sites are also major accomplishments. Yet, getting well-designed green infrastructure and stormwater management practices in the ground is only the first step ensuring that they will perform as designed over time. Ongoing maintenance is also needed to ensure that these practices will continue to help control and minimize the negative impacts of the land development process.

Communities across coastal Georgia are becoming increasingly aware of the fact that both green infrastructure and stormwater management practices are infrastructure. And, like any other type of infrastructure, deferred maintenance has its price, both in terms of financial resources and the health of local aquatic resources. It is well understood that green infrastructure and stormwater management practices that are not properly maintained will ultimately fail to perform as designed, and may become nuisance or safety problems. Problems

that arise from deferred maintenance usually circle around and fall into the community's lap. Therefore, it is in any community's best interest to develop an effective inspection and maintenance program.

The tasks associated with developing an effective inspection and maintenance program are described below.

9.9.1 Step 7.1: Scoping the Inspection and Maintenance Program

The first task that needs to be completed when developing an inspection and maintenance program is to scope out the program. There are three general approaches that a community can use to develop an inspection and maintenance program: (1) private property owners are responsible for performing maintenance, with the local program providing oversight and guidance; (2) the local program is responsible for performing maintenance; and (3) a hybrid approach with a blend of public and private maintenance. Every one of Georgia's coastal communities should explore each of these options and select an approach that will best meet its own needs and budgetary constraints.

When scoping an inspection and maintenance program, a community needs to consider how often inspections will occur, the information that will need to be collected during each inspection, the maintenance requirements that are contained in the local post-construction stormwater management ordinance and how these requirements will be enforced. A list of scoping questions is provided below to assist communities in completing this task:

- How many green infrastructure and stormwater management practices can be found within the community?
- What is the current condition of these green infrastructure and stormwater management practices?
- What types of maintenance tasks are already being conducted within the community?
- Who is currently responsible for maintenance of green infrastructure and stormwater management practices?
- How often will existing green infrastructure and stormwater management practices need to be inspected?
- What is the current level of knowledge among inspectors about the maintenance requirements of green infrastructure and stormwater management practices?
- How often will maintenance need to take place on existing green infrastructure and stormwater management practices?
- Is there an existing tracking system that can be used to track the results of maintenance inspections?

The answers to these questions will help a community identify the action items that will need to be completed to develop an effective inspection and maintenance program.

9.9.2 Step 7.2: Create Checklists, Inspection Forms and Enforcement Tools

Forms and checklists need to be created so that inspection and maintenance activities can be tracked. Inspection documents should describe the existing condition of each green infrastructure and stormwater management practice, propose remedies for any noted deficiencies and identify potential enforcement actions. Checklists and inspection forms should:

- Be quantitative, so that maintenance needs can be easily prioritized and ranked
- Allow for the distinction between routine and structural maintenance needs

- Be very specific about possible problems to reduce subjectivity
- Link problems to specific actions
- Gather data on the design features of practices for future use
- Where possible, track the function of the practice over time for future research (e.g., health of vegetation)

These documents should be carefully compiled, as the information contained within them may be necessary for enforcement action in the future. Additional information about developing checklists and inspection forms, including example inspection checklists, is provided in *Managing Stormwater in Your Community: A Guide for Building an Effective Post-Construction Program* (Hirschman and Kosco, 2008).

9.9.3 Step 7.3: Forecast Staff Needs and Acquire Inspection Staff

Generally, the same local inspection staff that performs inspection of green infrastructure and stormwater management practices during construction can be utilized to perform maintenance inspections. These inspectors may be inspectors from other municipal departments (e.g., building or erosion and sediment control inspectors), stormwater plan reviewers, specialized stormwater inspection staff or private consultants. The same pros and cons that were presented in Section 9.9.3 also apply to maintenance inspections, and should be considered accordingly.

9.9.4 Step 7.4: Create and Disseminate Outreach Materials for Responsible Parties

With improved stormwater regulations comes greater responsibility, both for the regulated community and for the community itself. This is especially true for the inspection and maintenance aspect of a post-construction stormwater management program, which is often neglected. In many communities, the community is responsible for maintaining public stormwater infrastructure. However, most green infrastructure and stormwater management practices are typically installed on private property, which leaves individual property owners and homeowners' associations responsible for their maintenance. On these sites, communities should still perform periodic inspections, and will therefore need to obtain adequate easements or permission for inspection access and emergency repair.

Often, the parties responsible for post-construction stormwater management are residential or commercial property managers that have no prior experience in maintaining stormwater infrastructure. This lack of experience can lead to poor compliance with maintenance requirements. Local governments can improve compliance by providing educational and outreach programs that provide residential and commercial property managers with the knowledge they need to properly inspect green infrastructure and stormwater management practices and perform any required maintenance tasks.

9.10 Step 8: Develop Program Tracking and Evaluation System

The ultimate goal of all local post-construction stormwater management programs should be to better protect coastal Georgia's aquatic and terrestrial resources from the negative impacts of the land development process. In order to achieve this goal, communities should regularly review and revise their programs to address any successes (and failures) that they have had in meeting program goals and objectives. Some of the primary reasons for tracking and evaluating local post-construction stormwater management programs include:

- Identifying and implementing program improvements to better protect coastal Georgia's aquatic and terrestrial resources from the negative impacts of the land development process
- Striving to make programs more efficient and cost-effective
- Documenting program status for annual reports, as required under the NPDES Municipal Stormwater Program
- Preparing for a possible program audit from state and/or federal regulatory agencies

Setting up a program tracking and evaluation system assures that, even if a community's initial stormwater management goals and objectives prove to be unachievable, it can adjust its program and continue to address its natural resource protection and stormwater management goals and objectives. This important final step in the *stormwater management program development process* is discussed in more detail below.

9.10.1 Step 8.1: Develop a Framework for Program Tracking and Evaluation

Fundamentally, a community's tracking and evaluation program should seek to answer three basic questions:

- Are local natural resource protection and stormwater management goals and objectives being met?
- Is the post-construction stormwater management program being implemented as it was originally envisioned?
- What improvements can be made to the local post-construction stormwater management program?

In order to provide the knowledge necessary to objectively answer these three questions, a community should establish and make use of some program tracking indicators. A wide range of indicators may be used, but some of the more popular indicators include:

- Programmatic Indicators: Programmatic indicators are used to evaluate the success of the local post-construction stormwater management program against qualitative program milestones. Example programmatic indicators include: successfully adopting of a post-construction stormwater management ordinance; developing a stormwater guidance manual; hiring additional plan review staff; and establishing a local construction inspection program.
- Water Quality Indicators: Water quality indicators are used to measure the health of the aquatic resources found within and around a community. This can be done directly (e.g., in stream monitoring) or indirectly (e.g., water quality modeling). Although water quality monitoring and modeling can be expensive, some targeted water quality sampling can be very useful in evaluating the success of a local post-construction stormwater management program in meeting its goals and objectives.
- Land Use/Land Cover Indicators: Land use/land cover indicators are used to measure the extent to which development has occurred within a community. Land use/land cover can be an important measure of program success, and it can help guide future local land use planning and zoning decisions.
- Stormwater Infrastructure Indicators: Stormwater infrastructure indicators are used to determine where green infrastructure and stormwater management practices are successfully meeting local natural resource protection and stormwater management

goals and objectives. Tracking and evaluating the performance of individual green infrastructure and stormwater management practices can be an important measure of program success, and it can help guide future decisions about what practices to use (and not to use) within a community.

The indicators that a community chooses to use to evaluate its local post-construction stormwater management program should be relatively simple to measure and track over time.

9.10.2 Step 8.2: Develop Program Tracking and Evaluation Protocols

Once a community has developed a framework for program tracking and evaluation, the next step is to develop a tracking and evaluation protocol for each program tracking indicator. Each protocol should describe the information that needs to be collected to evaluate the indicator and should define how often the indicator will be assessed.

At its core, program tracking and evaluation involves keeping track of all of the tasks that have been completed to meet program goals and objectives. Many of the tasks can be tracked with a simple checklist (e.g., successful adoption of a local stormwater ordinance) and require no detailed or long-term data tracking. Other tasks, however, require more detailed and ongoing record-keeping, sometimes by several different departments within the same community (e.g., keeping track of the condition of all of the green infrastructure and stormwater management practices that have been installed in the community). Regardless of the tracking and evaluation protocols that are used, it is important for a community to keep track of what tasks have and have not been completed so that annual reports can be more easily created.

9.10.3 Step 8.3: Write Annual Reports

All communities that are regulated under the NPDES Municipal Stormwater Program must submit an annual report to the Georgia Department of Natural Resources Environmental Protection Division (GA EPD) documenting the activities that they have completed to comply with the requirements of the program. The NPDES Municipal Stormwater Program requires that these reports include the following information:

- Status of compliance with permit conditions
- Status of selected measurable goals
- Assessment of the appropriateness and effectiveness of the stormwater management program
- Summary of any data, including any monitoring data, collected and analyzed during the reporting period
- Summary of any stormwater management activities planned for the next reporting cycle
- Summary of any proposed changes to the stormwater management program along with a written statement providing rationale for the proposed changes
- List of entities responsible for implementing any aspect of the stormwater management program
- List of any changes in the personnel responsible for implementing and coordinating the stormwater management program

Many communities use their annual reports to simply report the tasks they have completed over the past year, instead of using them to determine if any improvements can be made to the program. For example, if a community reports that it has inspected 12 dry detention basins over the past year, and 10 were in need of maintenance, the community should assess the situation

and determine why so many of the dry detention basins were in need of maintenance. The knowledge gained from this type of annual “self-assessment” can be used to revise and improve the local post-construction stormwater management program over time.

9.11 Summary

By following the eight-step *stormwater management program development process* described above, communities can effectively shift the focus of their local post-construction stormwater management efforts onto the *prevention*, rather than the *mitigation*, of the negative impacts of the land development process. Programs developed in accordance with this eight-step process will not only be consistent with the integrated, *green infrastructure*-based approach to natural resource protection, stormwater management and site design presented in this CSS, but also with the requirements of the NPDES Municipal Stormwater Program.

References

- Carter, T. 2008. *Stormwater Utility Handbook: A Step-by-Step Guide to Establishing a Utility in Coastal Georgia*. University of Georgia. River Basin Center. Athens, GA. Available Online: <http://www.rivercenter.uga.edu/research/coastal.htm>.
- Center for Watershed Protection (CWP). 1998. *Better Site Design: A Handbook for Changing Development Rules in Your Community*. Center for Watershed Protection. Ellicott City, MD. Available Online: http://www.cwp.org/Resource_Library/Controlling_Runoff_and_Discharges/sm.htm.
- Georgia Department of Community Affairs (DCA). 2008. Draft Coastal Comprehensive Plan. Georgia Department of Community Affairs. Office of Planning and Quality Growth. Atlanta, GA. Available Online: <http://www.dca.state.ga.us/development/PlanningQualityGrowth/programs/coastalplan.asp>.
- Georgia Department of Natural Resources Environmental Protection Division (EPD). 2008. *Comprehensive Statewide Water Management Plan*. Georgia Department of Natural Resources. Environmental Protection Division. Atlanta, GA. Available Online: <http://www.georgiawatercouncil.org/>
- Hirschman, D.J. and J. Kosco. 2008. *Managing Stormwater in Your Community: A Guide for Building and Effective Post-Construction Program*. EPA 833-R-08-001. Prepared For: U.S. Environmental Protection Agency. Center for Watershed Protection. Ellicott City, MD. Available Online: http://www.cwp.org/Resource_Library/Controlling_Runoff_and_Discharges/sm.htm.

THIS PAGE INTENTIONALLY LEFT BLANK

Glossary

“Applicant” means a property owner or agent of a property owner who has submitted an application for a post-construction stormwater management permit.

“Aquatic Buffer” means an area of land located around or near a stream, wetland, or waterbody that has intrinsic value due to the ecological services it provides, including pollutant removal, erosion control and conveyance and temporary storage of flood flows.

“Aquatic Resource Protection” means measures taken to protect aquatic resources from several negative impacts of the land development process, including complete loss or destruction, stream channel enlargement and increased salinity fluctuations.

“Better Site Design Techniques” means site design techniques that can be used during the site planning and design process to minimize land disturbance and the creation of new impervious and disturbed pervious cover. Better site design techniques include reducing clearing and grading limits, reducing roadway lengths and widths and reducing parking lot and building footprints.

“Better Site Planning Techniques” means site planning techniques that can be used during the site planning and design process to protect valuable aquatic and terrestrial resources from the direct impacts of the land development process. Better site planning techniques include protecting primary and secondary conservation areas.

“Building” means any structure, either temporary or permanent, having walls and a roof, designed for the shelter of any person, animal or property and occupying more than 100 square feet of area.

“Channel” means a natural or artificial watercourse with a definite bed and banks that conducts continuously or periodically flowing water.

“Conservation Areas” means permanently protected areas of a site that are preserved, in perpetuity, in an undisturbed, natural state.

“Conservation Easement” means a legal agreement between a land owner and a local, state or federal government agency or land trust that permanently protects conservation areas on the owner’s land by limiting the amount and type of development that can take place within them but continues to leave the conservation areas in private ownership.

“Dedication” means the deliberate appropriation of property by its owner for general public use.

“Detention” means the temporary storage of stormwater runoff in a stormwater management practice for the purpose of controlling the peak discharge rates and providing gravitational settling of pollutants.

“Developer” means a person who undertakes a land development project.

“Development Project” means a new development or redevelopment project.

“Development Site” means a parcel of land where land disturbing activities have been or will be initiated to complete a land development project.

“Drainage Easement” means a legal right granted by a land owner to a grantee allowing the grantee to convey, treat or manage stormwater runoff on the private land subject to the drainage easement.

“Easement” means a legal right granted by a land owner to a grantee allowing the use of private land for conveyance, treatment and management of stormwater runoff and access to green infrastructure and stormwater practices.

“Ecotone” means a transitional area between two adjacent ecological communities. Ecotones may appear on the ground as a gradual blending of two ecological communities across a broad area, or they may manifest themselves as sharp boundary lines.

“Erosion and Sediment Control Plan” means a plan that is designed to minimize and control the accelerated erosion and increased sediment loads that occur at a site during land disturbing activities.

“Evapotranspiration” means the loss of water to the atmosphere through both evaporation and transpiration, which is the evaporation of water from the aerial parts of plants.

“Extended Detention” means the temporary storage of stormwater runoff in a stormwater management practice for an extended period of time, typically 24 hours or greater.

“Extreme Flood Protection” means measures taken to protect downstream properties from dangerous extreme flooding events and help maintain the boundaries of the existing 100-year floodplain.

“Fee in Lieu Contribution” means a payment of money in place of meeting all or part of the stormwater management criteria required by a post-construction stormwater management ordinance.

“Flooding” means a volume of stormwater runoff that is too great to be confined within the banks of a stream, river or other aquatic resource or walls of a stormwater conveyance feature and that overflows onto adjacent lands.

“Green Infrastructure Practices” means the combination of three complementary, but distinct, groups of natural resource protection and stormwater management practices and techniques, including better site planning and design techniques and low impact development practices, that are used to protect valuable terrestrial and aquatic resources from the direct impacts of the land development process, maintain pre-development site hydrology and reduce post-construction stormwater runoff rates, volumes and pollutant loads.

“Hydrologic Soil Group (HSG)” means a Natural Resource Conservation Service classification system in which soils are categorized into four runoff potential groups. The groups range from group A soils, with high permeability and little runoff produced, to group D soils, which have low permeability rates and produce much more runoff.

“Impaired Waters” means those streams, rivers, lakes, estuaries and other water bodies that currently do not meet their designated use classification and associated water quality standards under the Clean Water Act.

“Impervious Cover” means a surface composed of any material that greatly impedes or prevents the natural infiltration of water into the underlying native soils. Impervious surfaces include, but are not limited to, rooftops, buildings, sidewalks, driveways, streets and roads.

“Industrial Stormwater Permit” means a National Pollutant Discharge Elimination System (NPDES) permit issued to an industry or group of industries that regulates the pollutant levels associated with industrial stormwater discharges or specifies on-site pollution control strategies.

“Infill Development” means land development that occurs within designated areas based on local land use, watershed and/or utility plans, where the surrounding area is generally developed, and where the site or area is either vacant or has previously been used for another purpose.

“Infiltration” means the process of allowing stormwater runoff to percolate into the underlying native soils.

“Infiltration Practice” means a green infrastructure or stormwater management practice designed to provide infiltration of stormwater runoff into the underlying native soils. These stormwater management practices may be above or below grade.

“Inspection and Maintenance Plan” means a written agreement and plan providing for the long-term inspection and maintenance of all green infrastructure practices, stormwater management practices, stormwater conveyance features and stormwater drain infrastructure on a development site.

“Interception” means the process by which precipitation is caught and held by foliage, twigs and branches of trees, shrubs and other vegetation, and lost by evaporation, never reaching the surface of the ground.

“Jurisdictional Wetland” means an area that is inundated or saturated by surface water or groundwater at a frequency and duration sufficient to support a prevalence of vegetation typically adapted for life in saturated soil conditions, commonly known as hydrophytic vegetation.

“Land Development” means any project undertaken to change or improve a site that involves one or more land disturbing activities.

“Land Disturbing Activity” means any activity that changes stormwater runoff rates, volumes and pollutant loads on a site. These activities include, but are not limited to, the grading, digging, cutting, scraping, or excavating of soil, the placement of fill materials, paving, construction, substantial removal of vegetation and any activity that bares soil or rock or involves the diversion or piping of any natural or man-made watercourse.

“Land Owner” means the legal or beneficial owner of land, including those holding the right to purchase or lease the land, or any other person holding proprietary rights in the land.

“Low Impact Development Practice” means small-scale stormwater management practices that are used to disconnect impervious and disturbed pervious surfaces from the storm drain system and reduce post-construction stormwater runoff rates, volumes and pollutant loads. Low impact development practices include soil restoration, site reforestation/revegetation, green roofs, vegetated filter strips and rain gardens.

“National Pollutant Discharge Elimination System (NPDES) Stormwater Discharge Permit” means a permit issued by the EPA, or by a State under authority delegated pursuant to 33 USC § 1342(b), that authorizes the discharge of pollutants to waters of the State, whether the permit is applicable on an individual, group, or general area-wide basis.

“New Development” means a land development project undertaken on a previously undeveloped or unimproved site.

“Nonpoint Source Pollution” means pollution from any source other than from a discernible, confined and discrete conveyance, such as a wastewater treatment plant or industrial discharge. Sources of nonpoint source pollution include, but are not limited to, agricultural, silvicultural, mining and construction activities, subsurface disposal and urban stormwater runoff.

“Nonstructural Stormwater Management Practice” means any natural resource protection or stormwater management practice or technique that uses natural processes and natural systems to intercept, convey, treat and/or manage stormwater runoff. Nonstructural stormwater management practices include, but are not limited to, protecting primary and secondary conservation areas, reducing clearing and grading limits, reducing roadway lengths and widths, reducing parking lot and building footprints, soil restoration, site reforestation/revegetation, green roofs, vegetated filter strips and rain gardens.

“Off-Site Stormwater Management Practice” means a green infrastructure or stormwater management practice located outside the boundaries of a development site.

“On-Site Stormwater Management Practice” means a green infrastructure or stormwater management practice located within the boundaries of a development site.

“Overbank Flood Protection” means measures taken to protect downstream properties from damaging overbank flooding events.

“Owner” means the legal or beneficial owner of a piece of land, including, but not limited to, a mortgagee or vendee in possession, receiver, executor, trustee, lessee or other person, firm, or corporation in control of the site.

“Permanent Stormwater Management Practice” means a green infrastructure or stormwater management practice that will be operational after the land disturbing activities are complete and that is designed to become a permanent part of the site for the purposes of managing post-construction stormwater runoff.

“Permit” means the permit issued by a local development review authority to an applicant, which is required for undertaking any land development project or land disturbing activities.

“Person” means any individual, partnership, firm, association, joint venture, public or private corporation, trust, estate, commission, board, public or private institution, utility, cooperative, city, county or other political subdivision, any interstate body, or any other legal entity.

“Post-Development Hydrology” refers to the set of hydrologic conditions that may reasonably be expected to exist on a development site, after the completion of all land disturbing and construction activities.

“Pre-Development Hydrology” refers to the set of hydrologic conditions that exist on a development site prior to the commencement of any land disturbing activities and at the time

that plans for the land development project are approved by the local development review authority.

“Receiving Stream” or **“Receiving Aquatic Resource”** means the body of water or conveyance into which stormwater runoff is discharged.

“Recharge” means the replenishment of groundwater aquifers.

“Redevelopment” means a change to previously existing, improved property, including but not limited to the demolition or building of structures, filling, grading, paving, or excavating, but excluding ordinary maintenance activities, remodeling of buildings on the existing footprint, resurfacing of paved areas and exterior changes or improvements that do not materially increase or concentrate stormwater runoff or cause additional nonpoint source pollution.

“Regional Stormwater Management Practice” means a stormwater management practice designed to control stormwater runoff from multiple properties, where the owners or developers of the individual properties may participate in providing land, financing, design services, construction services and/or maintenance services for the practice.

“Responsible Party” means any individual, partnership, co-partnership, firm, company, corporation, association, joint stock company, trust, estate, governmental entity, or any other legal entity; or their legal representatives, agents, or assigns that is named on a stormwater inspection and maintenance agreement and plan as responsible for the long-term operation and maintenance of one or more green infrastructure or stormwater management practices.

“Site” means development site.

“Stop Work Order” means an order issued that requires that all land disturbing activity on a site be stopped.

“Stormwater Hotspot” means an area where land use or pollution generating activities have the potential to generate highly contaminated runoff, with concentrations of pollutants in excess of those typically found in stormwater runoff. Stormwater hotspots include, but are not limited to, fueling stations (including temporary fueling stations during construction), golf courses, public works yards and marinas.

“Stormwater Management” means the interception, conveyance, treatment and management of stormwater runoff in a manner that is intended to prevent increased flood damage, channel erosion, habitat degradation and water quality degradation and to enhance and promote the public health, safety and general welfare.

“Stormwater Management Plan” means a written document that details how stormwater runoff will be managed on a development site and that shows how the stormwater management criteria that apply to the development project have been met.

“Stormwater Management Practice” means a practice or technique, either structural or nonstructural, that is used to intercept stormwater runoff and change the characteristics of that runoff. Stormwater management practices are used to control post-construction stormwater runoff rates, volumes and pollutant loads to prevent increased flood damage, channel erosion, habitat degradation and water quality degradation.

“Stormwater Management System” means the entire suite of green infrastructure and stormwater management practices and stormwater conveyance features that are used to intercept, convey, treat and manage stormwater runoff on a development site.

“Stormwater Retrofit” means a green infrastructure or stormwater management practice designed for an existing development site that previously had no green infrastructure or stormwater management practice in place or had a practice that was not meeting local stormwater management criteria.

“Stormwater Runoff” means surface water resulting from precipitation.

“Stormwater Runoff Reduction” means providing for the interception, evapotranspiration, infiltration, or capture and reuse of stormwater runoff to help maintain pre-development site hydrology and help protect aquatic resources from several indirect impacts of the land development process, including decreased groundwater recharge, decreased baseflow and degraded water quality.

“Subdivision” means the division of a parcel of land to create one or more new lots or development sites for the purpose, whether immediately or in the future, of sale, transfer of ownership, or land development, and includes divisions of land resulting from or made in connection with the layout or construction of a new street or roadway or a change in the layout of an existing street or roadway.

“Watercourse” means a permanent or intermittent stream or other body of water, either natural or man-made, which gathers or carries surface water.

“Watershed Management Plan” or **“Subwatershed Management Plan”** means a document, usually developed cooperatively by government agencies and other stakeholders, to protect, restore and/or otherwise manage the water resources found within a particular watershed or subwatershed. Watershed or subwatershed management plans commonly identify threats, sources of impairment, institutional issues and technical and programmatic solutions or projects to protect and/or restore water resources.

“Water Quality Protection” means adequately treating stormwater runoff before it is discharged from a development site to help protect downstream aquatic resources from water quality degradation.

“Wetland Hydroperiod” means the pattern of fluctuating water levels within a wetland caused by the complex interaction of surface water, groundwater, topography, soils and geology within a wetland.

Appendix A High Priority Plant and Animal Species and Habitat Areas

A.1 Introduction

At least 71 high priority animal species can be found in coastal Georgia, including 27 birds, 14 reptiles, 10 mammals, 7 amphibians, 7 mollusks, 5 fish and 1 aquatic arthropod (WRD, 2005). These high priority animal species are listed in Table A.1, along with information on global and state rarity ranks, protected status (if any) under federal or state law and habitat and range in coastal Georgia. In addition, at least 91 high priority plants species can be found in coastal Georgia (WRD, 2005). These species are listed in Table A.2.

Because of the habitat that they provide for these high priority plant and animal species, a total of 25 high priority habitat areas can be found in coastal Georgia. These priority habitat areas are listed and briefly described in Table A.3.

Table A.1: High Priority Animal Species Found in Coastal Georgia
(Source: WRD, 2005)

Scientific Name	Common Name	Global Rank	State Rank	Federal Status	State Status	Habitat in Georgia	Range in Georgia
<i>Cordulegaster sayi</i>	Say's spiketail	G2	S1			Trickling hillside seepages in deciduous forest near weedy fields	Southeastern coastal plain only.
<i>Ambystoma cingulatum</i>	Flatwoods salamander	G2G3	S2	LT	T	Pine flatwoods; moist savannas; isolated cypress/gum ponds	Lower CP, extremely localized throughout large but fragmented range. Only four sites with known extant populations
<i>Desmognathus auriculatus</i>	Southern dusky salamander	G5	S3			In or around the margins of slowly moving or stagnant bodies of water with mucky, acidic soils; cypress swamps, floodplains, sloughs	Lower CP
<i>Necturus punctatus</i>	Dwarf waterdog	G4	S2			Sluggish streams with substrate of leaf litter or woody debris	Atlantic drainages, primarily CP, one record in the PD
<i>Notophthalmus perstriatus</i>	Striped newt	G2G3	S2		R	Pine flatwoods, sandhills; isolated wetlands	CP
<i>Pseudobranchius striatus</i>	Dwarf siren	G5	S3			Swamps; marshes; limesink ponds; cypress ponds	lower CP
<i>Rana capito</i>	Gopher frog	G3G4	S3			Sandhills; dry pine flatwoods; breed in isolated wetlands	CP
<i>Stereochilus marginatus</i>	Many-lined salamander	G5	S3			Sluggish, swampy streams and bayheads with substrate of leaf litter	eastern CP
<i>Aimophila aestivalis</i>	Bachman's sparrow	G3	S3	SAR	R	Open pine or oak woods; old fields; grassy forest regeneration	RV, PD, CP: where appropriate habitat
<i>Ammodramus henslowii</i>	Henslow's sparrow	G4	S3	SAR		Grassy areas, especially wet grasslands; wet pine savanna & flatwoods	CP, PD - historically and migrants
<i>Ammodramus savannarum</i>	Grasshopper sparrow	G5	S4			Grassland surrounded by open country (ag, grassland etc.)	CP, PD predominantly, less common in CU, RV, rare in BR
<i>Calidris canutus</i>	Red knot (SE winter population)	G5	S3	SAR		Beaches and sandbars	Coastal
<i>Charadrius melodius</i>	Piping plover	G3	S1	(LE,LT)	T	Sandy beaches; mud and sand flats; isolated sand spits	CP - coastal
<i>Charadrius wilsonia</i>	Wilson's plover	G5	S2		R	Sandy beaches; sand and mud flats, dunes and back dune swales	CP - coastal
<i>Colinus virginianus</i>	Northern bobwhite	G5	S4			Early successional mixed grass/forb habitat; longleaf pine savanna	CP most numerous; uncommon in PD, RV; scattered in CU, BR
<i>Egretta tricolor</i>	Tricolored heron	G5	S3			Coastal aquatic environments, salt and fresh, nests with other waders in low thick cover	All coastal counties
<i>Elanoides forficatus</i>	Swallow-tailed kite	G5	S2	SAR	R	River swamps and upland adjacent habitats particularly with large, emergent pines and pine islands; marshes	CP - nesting primarily in SE CP with scattered records statewide post breeding

Table A.1: High Priority Animal Species Found in Coastal Georgia
(Source: WRD, 2005)

Scientific Name	Common Name	Global Rank	State Rank	Federal Status	State Status	Habitat in Georgia	Range in Georgia
<i>Falco sparverius paulus</i>	Southeastern American kestrel	G5T4	S3	SAR		Pine sandhills and savannas; open country with scattered trees for nesting; military base habitats; artificial/man-made nesting habitats include nest boxes, power poles, building columns	CP
<i>Grus canadensis pratensis</i>	Florida sandhill crane	G5T2T3	S1			Freshwater prairies	Restricted to Okefenokee and Grand Bay
<i>Haematopus palliatus</i>	American oystercatcher	G5	S2	SAR	R	Sandy beaches; tidal flats; salt marshes, oyster shell bars	CP - coastal
<i>Haliaeetus leucocephalus</i>	Bald eagle	G4	S2	(PS:LT,P DL)	E	Edges of lakes & large rivers; seacoasts	CP - primarily and reservoirs and rivers PD, BR, RV
<i>Himantopus mexicanus</i>	Black-necked stilt	G5	S3	(PS)		Shallow ponds; lagoons; isolated freshwater wetlands; dredge spoil sites; managed wetlands	CP - coastal
<i>Ixobrychus exilis</i>	Least bittern	G4	S3			Freshwater and brackish marshes with tall, dense emergent vegetation. Nests close to open areas	Probably more common as a breeder in CP due to much more potentially suitable habitat than in PD
<i>Lanius ludovicianus migrans</i>	Loggerhead shrike	G4T3Q	S?	SAR		Open woods; field edges; savannas	CP - primary area of abundance; scattered and low number in the PD (none in 20-county metro Atlanta area); low numbers in RV
<i>Laterallus jamaicensis</i>	Black rail	G4	S2?	SAR		Freshwater marsh grassy margins; wet grassy meadows; brackish high marsh	PD, CP - most likely breeding would occur in eastern PD or along Coast
<i>Limnothlypis swainsonii</i>	Swainson's warbler	G4	S3	SAR		Dense undergrowth with heavy litter (CP,M); canebrakes in swamps and river floodplains (CP)	Although found widespread, bulk of population restricted to river floodplains of CP and PD; small BR population
<i>Mycteria americana</i>	Wood stork	G4	S2	(PS:LE)	E	Cypress/gum ponds; freshwater marshes; saltmarshes, river swamps; bays, isolated wetlands, ephemeral wetlands, coastal hammocks	1,200 pairs nesting in Coastal Plain 2002, with post-nest dispersal throughout state
<i>Numenius phaeopus</i>	Whimbrel	G5	S3			Saltmarsh openings, Mud flats, shell rakes, outer barrier sand spits	All coastal counties
<i>Passerina ciris</i>	Painted bunting	G5	S3	SAR		Shrub-scrub and open grassy habitats; open mature pine forest and maritime oak forest associated with freshwater wetlands	CP - primarily barrier islands and immediate coast with scattered occurrences up major river corridors; occurrences in CP agricultural lands reduced and poorly understood

Table A.1: High Priority Animal Species Found in Coastal Georgia
(Source: WRD, 2005)

Scientific Name	Common Name	Global Rank	State Rank	Federal Status	State Status	Habitat in Georgia	Range in Georgia
Picoides borealis	Red-cockaded woodpecker	G3	S2	LE	E	Open pine woods; pine savannas	Found mostly in CP, also lower PD. Disjunct populations in counties of Muscogee, Chattahoochee (Ft Benning); Liberty, Long, Bryan (Ft Stewart); Charlton, Brantley (Okefenokee NWR, private); Jones, Jasper (Piedmont NWR, Oconee NF, Hitchiti); Thomas, Grady
Rallus elegans	King rail	G4G5	S3			Freshwater marshes, often cattail bulrush, cutgrass, for breeding; also brackish marshes non-breeding (saltmarshes?)	Principally Piedmont and CP; possibly R&V
Rynchops niger	Black skimmer	G5	S1			Sandy beaches, isolated accretional sand spits, N and S tips of barrier islands	Strictly outer coast
Sterna antillarum	Least tern	G4	S3	(PS:LE)	R	Sandy beaches; sandbars, large flat gravel roof tops	Coastal Counties
Sterna nilotica	Gull-billed tern	G5	S1		T	Outer sand beaches and mud flats, Salt marshes; fields on barrier islands; Isolated sand spits	Coastal
Tyto alba	Barn owl	G5	S3/S4			Grassland savanna with large cavity trees, also neighborhoods with large cavity trees, generally needs open country	Local: CP, PD, RV, CU, rare in BR
Acipenser brevirostrum	Shortnose sturgeon	G3	S2	LE	E	Estuaries; lower end of large rivers in deep pools with soft substrates	Atlantic drainage large rivers
Elassoma okatie	Bluebarred pygmy sunfish	G2G3	S1S2			Temporary ponds and stream backwaters with dense aquatic vegetation	Fort Gordon
Enneacanthus chaetodon	Blackbanded sunfish	G4	S1		R	Blackwater streams; bays; cypress/gum ponds	Disjunct historic locales in SE GA; T. Peterson (recent) able to find at one historic locale outside of OK Swamp
Lucania goodei	Bluefin killifish	G5	S1		U	Heavily vegetated ponds and streams with little or no current; frequently associated with springs	Lower Flint River system and in McIntosh County on east coast of GA
Micropterus notius	Suwannee bass	G3	S2		R	Flowing water over rocky shoals or large springs and spring runs	Suwannee drainage so. GA
Condylura cristata	Star-nosed mole	G5	S2?			Moist meadows; woods; swamps	Known only from Charlton, Chatham, Clinch, Effingham, Jackson and Union counties
Corynorhinus rafinesquii	Rafinesque's big-eared bat	G3G4	S3?		R	Pine forests; hardwood forests; caves; abandoned buildings; bridges; bottomland hardwood forests and cypress-gum swamps	Range in state disjunct--C.r.rafinesquii found in northern BR and C. r. macrotis found in lower CP. Not known from PD, but either subsp might occur there.

Table A.1: High Priority Animal Species Found in Coastal Georgia
(Source: WRD, 2005)

Scientific Name	Common Name	Global Rank	State Rank	Federal Status	State Status	Habitat in Georgia	Range in Georgia
<i>Eubalaena glacialis</i>	North Atlantic right whale	G1	S1 and S?	LE	E	Inshore and offshore oceanic waters of Georgia	Occurs along the entire Georgia coast and also observed offshore up to 40 nm. Most frequently observed in waters > 8ft. Maximum depth or distance from shore is unknown but strongly suspected to occur West of the Gulf Stream
<i>Geomys pinetis</i>	Southeastern pocket gopher	G5	S4			Sandy well-drained soils in open pine woodlands with grassy or herbaceous groundcover, fields, grassy roadsides	Fairly widespread over CP, but population apparently greatly reduced and fragmented; small local populations
<i>Lasiurus intermedius</i>	Northern yellow bat	G4G5	S2S3			Wooded areas near open water or fields	Has been found only in lower CP
<i>Neofiber alleni</i>	Round-tailed muskrat	G3	S3		T	Freshwater marshes; bogs	Okefenokee and surrounding areas in Camden, Charlton and Ware; also Grand Bay WMA in Lanier and Lowndes; also Brooks.
<i>Sciurus niger shermani</i>	Sherman's fox squirrel	G5T2	S?			Pine forests; pine savannas	Some sources say this subspecies only occurs in extreme SE corner of Georgia around Okefenokee Swamp. However, Turner and Laerm (1993) say <i>S.n. shermani</i> occurs up into Piedmont.
<i>Trichechus manatus</i>	West Indian manatee	G2	S1S2	LE	E	Inshore ocean; estuaries, tidal rivers, warm and fresh water discharges	Found in six coastal counties. These animals are unique because they can migrate between fresh and salt water.
<i>Tursiops truncatus</i>	Bottlenose dolphin	G5	S?			Coastal estuarine and offshore waters of Georgia	Bottlenose dolphins range in all 6 coastal counties; Camden, Glynn, McIntosh, Liberty, Bryan and Chatham. All tidal rivers and creeks provide dolphin habitat. They also extend offshore. CP.
<i>Ursus americanus floridanus</i>	Florida black bear	G5T2	S2			Large undeveloped wooded tracts in areas that include multiple forest types	Parts of Echols, Clinch, Charlton, Ware and Brantley counties support breeding population. Individuals frequently wander into surrounding counties and along Altamaha corridor.
<i>Alasmidonta triangulata</i>	Southern elktoe	G2Q	S1			Large creeks and river mainstems in sandy mud and rock pools	Confined to the Chattahoochee, Flint, Ogeechee, Savannah river drainages

Table A.1: High Priority Animal Species Found in Coastal Georgia
(Source: WRD, 2005)

Scientific Name	Common Name	Global Rank	State Rank	Federal Status	State Status	Habitat in Georgia	Range in Georgia
<i>Alasmidonta varicosa</i>	Brook floater	G3	S2			Small rivers and creeks in sand and gravel shoals	Present distribution includes 4 sites in the Chattooga River in Rabun County (Savannah River drainage).
<i>Elliptio fraterna</i>	Brother spike	G1	SU			Sandy substrates of river channels with swift current	Uncertain of range in Savannah River system
<i>Fusconaia masoni</i>	Atlantic pigtoe	G2	S1		E	Moderate to fast current in substrate of sand or gravel	Historical range included 6 sites in the Ogeechee and Savannah River basins-all of which have been extirpated. One newly discovered population was found in Williamson Swamp Creek in Jefferson County (Alderman 1991).
<i>Medionidus walkeri</i>	Suwannee moccasinshell	G1	SH			Large creeks and medium-sized rivers with sand and gravel substrate	Endemic to the Suwannee River basin in GA and FL
<i>Quincuncina kleiniana</i>	Suwannee pigtoe	GU	S2			Small to large rivers in the Suwannee Basin, in slow to moderate current, pools of flowing rivers, often in detritus. More common in Alapaha and Withalacoochee rivers and tribs	Endemic to the Suwannee River basin in GA and FL
<i>Toxolasma pullus</i>	Savannah lilliput	G2	S2			Altamaha River; Savannah River	Historical distribution included the Altamaha River basin (Johnson 1970, Sepkoski and Rex 1974, Keferl 1981). Present distribution from recent surveys appears to be only the Ohoopsee River (Keferl pers. com.).
<i>Caretta caretta</i>	Loggerhead	G3	S2	LT	T	Open ocean; sounds; coastal rivers; beaches	Ocean, sounds, coastal rivers, beaches
<i>Chelonia mydas</i>	Green sea turtle	G3	S2	(LE,LT)	T	Open ocean; sounds; coastal rivers; beaches	Ocean, sounds, coastal rivers, beaches
<i>Clemmys guttata</i>	Spotted turtle	G5	S3		U	Heavily vegetated swamps, marshes, bogs and small ponds; nest and possibly hibernate in surrounding uplands	Widely distributed across CP
<i>Crotalus adamanteus</i>	Eastern diamondback rattlesnake	G4	S4			Early successional habitats on barrier islands and mainland; pine flatwoods; sandhills	CP, including barrier islands
<i>Dermochelys coriacea</i>	Leatherback sea turtle	G3	S2	LE	E	Open ocean; sounds; coastal beaches	Ocean, sounds, beaches
<i>Drymarchon couperi</i>	Eastern indigo snake	G4T3	S3	LT	T	Sandhills; pine flatwoods; dry hammocks; summer habitat includes floodplains and bottomlands	Middle and lower CP
<i>Eumeces anthracinus</i>	Coal skink	G5	S2			Mesic forests; often near streams, springs or bogs	Very little known about range especially in CP

Table A.1: High Priority Animal Species Found in Coastal Georgia
(Source: WRD, 2005)

Scientific Name	Common Name	Global Rank	State Rank	Federal Status	State Status	Habitat in Georgia	Range in Georgia
<i>Eumeces egregius</i>	Mole skink	G4	S3	(PS)		Coastal dunes; longleaf pine-turkey oak woods; dry hammocks	Widespread throughout CP
<i>Gopherus polyphemus</i>	Gopher tortoise	G3	S2	(PS:LT)	T	Sandhills; dry hammocks; longleaf pine-turkey oak woods; old fields	CP
<i>Heterodon simus</i>	Southern hognose snake	G2	S2			Sandhills; fallow fields; longleaf pine-turkey oak	CP
<i>Lepidochelys kempii</i>	Kemp's or Atlantic ridley	G1	S1	LE	E	Open ocean; sounds; coastal rivers; beaches	Ocean, sounds, coastal rivers
<i>Macrochelys temminckii</i>	Alligator snapping turtle	G3G4	S3		T	Large streams and rivers; impoundments; river swamps	Gulf CP drainages
<i>Malaclemys terrapin</i>	Diamondback terrapin	G4	S3			Entire coast, esturine and marine edge. All saltmarsh, beaches	Strictly Coastal
<i>Ophisaurus mimicus</i>	Mimic glass lizard	G3	S2			Pine flatwoods; savannas; seepage bogs	Lower CP, substantial gaps in range
<i>Pituophis melanoleucus mugitus</i>	Florida pine snake	G4T3?	S3			Sandhills; scrub; old field	CP
<i>Rhineura floridana</i>	Florida worm lizard	G4	S1			Dry upland hammocks, sand pine and longleaf pine-turkey oak sandhills; old fields	Lanier Co. in CP
<i>Tantilla relicta</i>	Florida crowned snake	G5	S1			Sandhills, scrub and moist hammocks	Lowndes Co. in CP

Table A.2: High Priority Plant Species Found in Coastal Georgia
(Source: WRD, 2005)

Scientific Name	Common Name	Global Rank	State Rank	Federal Status	State Status	Habitat in Georgia	Range in Georgia
<i>Amorpha georgiana</i> var. <i>georgiana</i>	Georgia indigo-bush	G3T2	S1			River terraces; floodplain woods; flint kaolin outcrop; mesic habitats with wiregrass, longleaf pine, mixed oaks	UCP
<i>Amorpha herbacea</i> var. <i>floridana</i>	Florida leadbush	G4T?Q	S1			River terraces along the Alapaha River	LCP, if accepted as taxonomically significant
<i>Arabis georgiana</i>	Georgia rockcress	G2	S1	C	T	Rocky or sandy river bluffs and banks, in circumneutral soil	PD, RV, UCP; along Coosa, Oostanaula and lower Chattahoochee Rivers
<i>Aristida simpliciflora</i>	Chapman three-awn grass	G3	SH			Longleaf pine-wiregrass savannas	UCP
<i>Arnoglossum diversifolium</i>	Variable-leaf Indian-plantain	G2	S2		T	Calcareous swamps	UCP
<i>Arnoglossum sulcatum</i>	Grooved-stem Indian-plantain	G2G3	S1			Bottomland forests	UCP
<i>Asplenium heteroresiliens</i>	Morzent's spleenwort	G2Q	S1		T	Limestone and marl outcrops; tabby ruins	UCP, LCP
<i>Astragalus michauxii</i>	Sandhill milkvetch	G3	S2			Longleaf pine-wiregrass savannas; turkey oak scrub	UCP
<i>Balduina atropurpurea</i>	Purple honeycomb head	G2G3	S2		R	Wet savannas, pitcherplant bogs	UCP, LCP
<i>Baptisia arachnifera</i>	Hairy rattleweed	G1	S1	LE	E	Pine flatwoods	LCP, entire global range in parts of Brantley and Wayne Cos.
<i>Brickellia cordifolia</i>	Heartleaf brickellia	G2G3	S2			Mesic hardwood forests	UCP
<i>Calamintha ashei</i>	Ashe's wild savory	G3	S2		T	Ochoopee dunes	UCP, Tattnall and Candler Cos.
<i>Campylopus carolinae</i>	Sandhills awned-moss	G1G2	S2?			Fall line sandhills; Altamaha Grit outcrops in partial shade of mesic oak forests	UCP
<i>Carex calcifugens</i>	Lime-fleeing sedge	G2G4	SR			Said by FNA to occur in "Mesic deciduous forests, in sandy loams and sands, usually on stream bank slopes."	LCP (only?)
<i>Carex dasycarpa</i>	Velvet sedge	G4?	S3		R	Evergreen hammocks; mesic hardwood forests	LCP, UCP
<i>Carex decomposita</i>	Cypress-knee sedge	G3	S2?			Swamps and lake margins on floating logs	LCP, UCP
<i>Carex godfreyi</i>	Godfrey's sedge	G3G4	S3?			Forested depressional wetlands.	UCP, possibly LCP?, uncertain, verification needed

Table A.2: High Priority Plant Species Found in Coastal Georgia
(Source: WRD, 2005)

Scientific Name	Common Name	Global Rank	State Rank	Federal Status	State Status	Habitat in Georgia	Range in Georgia
<i>Carex lupuliformis</i>	Mock hop sedge	G5	SU			Said by FNA to occur in "Wet forests, especially in openings around forest ponds, riverine wetlands, marshes, wet thickets, 0-500 m."	LCP?, uncertain, verification needed
<i>Coreopsis integrifolia</i>	Tickseed	G1G2	S1S2			Floodplain forests, streambanks	UCP, LCP
<i>Ctenium floridanum</i>	Florida orange-grass	G2	S1			Moist pine barrens	LCP
<i>Dicerandra radfordiana</i>	Radford's dicerandra	G1Q	S1			Sandridges	LCP, entire global range consists of 2 small areas in McIntosh Co.
<i>Eccremidium floridanum</i>	Florida eccremidium moss	G1?	S1			Sandy or sometimes clay soil in open, disturbed sites, often in areas that are wet part of the year and quite dry other parts of the year, fields and roadsides, thin soil over rock outcrops, around margins of cypress	UCP
<i>Eleocharis tenuis</i> var. <i>tenuis</i>	Slender spikerush	G5T?	SU			Moist to wet sandy-peaty soils; pine flatwoods	RV, PD, where doubtfully recorded and in need of comparison with other named varieties known to be present
<i>Elliottia racemosa</i>	Georgia plume	G2G3	S2S3		T	Scrub forests; Altamaha Grit outcrops; open forests over ultramafic rock	PD, UCP, LCP; from Ft. Stewart to Ashburn, Turner Co.; disjunct on piedmont on Burks Mtn., Columbia Co.
<i>Epidendrum conopseum</i>	Green-fly orchid	G4	S3		U	Epiphytic on limbs of evergreen hardwoods; also in crevices of Altamaha Grit outcrops	UCP, LCP; widespread, sometimes locally abundant especially in bottomland forests along major rivers in Southeast Georgia
<i>Eriochloa michauxii</i> var. <i>michauxii</i>	Michaux's cupgrass	G3G4T 3T4	S1?			Coastal freshwater and brackish marshes; flatwoods	LCP; map in FNA shows records from Charlton, Glynn, Liberty and McIntosh Cos.
<i>Eupatorium anomalum</i>	Florida boneset	G2G3	SU			Wet, low ground	LCP, UCP; likely close to Florida pending scrutiny of closely related <i>E. mohrii</i> and <i>E. rotundifolium</i>
<i>Evolvulus sericeus</i> var. <i>sericeus</i>	Creeping morning-glory	G5T?	S1		E	Altamaha Grit outcrops; open calcareous uplands	UCP
<i>Forestiera godfreyi</i>	Godfrey's wild privet	G2	S1			Mesic, maritime forests over shell mounds	LCP, Camden Co.
<i>Forestiera segregata</i>	Florida wild privet	G4	S2			Shell mounds on barrier islands in scrub or maritime forests	Restricted to shell middens overlooking or upon barrier islands; LCP
<i>Fothergilla gardenii</i>	Dwarf witch-alder	G3G4	S2		T	Openings in low woods and swamps; edges of seepage bogs	UCP, LCP; widely distributed from Fall Line Sandhills to more southern flatwoods

Table A.2: High Priority Plant Species Found in Coastal Georgia
(Source: WRD, 2005)

Scientific Name	Common Name	Global Rank	State Rank	Federal Status	State Status	Habitat in Georgia	Range in Georgia
<i>Habenaria quinqueseta</i> var. <i>quinqueseta</i>	Michaux's orchid	G4G5T ?	S1			Moist shade, Altamaha Grit outcrops; open pine woods	UCP, LCP; widely scattered sites
<i>Hartwrightia floridana</i>	Hartwrightia	G2	S1		T	Wet savannas; ditches, sloughs and flatwood seeps	LCP, restricted to Okefenokee Basin
<i>Hypericum</i> sp. 3	Georgia St.-John's-wort	G2G3	S2S3			Seepage bogs; roadside ditches	UCP, LCP, upper Ogeechee and Canoochee watersheds (only?) and near Eulonia, McIntosh Co.
<i>Justicia angusta</i>	Narrowleaf water-willow	G3Q	SH			Roadside ditches; perhaps with <i>Hartwrightia</i> in shallow sloughs and wet savannas	LCP
<i>Lachnocaulon beyrichianum</i>	Southern bog-button	G2G3	S1			Flatwoods	UCP, LCP
<i>Leitneria floridana</i>	Corkwood	G3	S1			Swamps; sawgrass-cabbage palmetto marshes	UCP, LCP
<i>Lindera melissifolia</i>	Pondberry	G2	S1	LE	E	Margins of seasonal ponds, both sandhill and limesink with swamp blackgum (<i>Nyssa biflora</i>).	LCP, UCP
<i>Litsea aestivalis</i>	Pondspice	G3	S2		T	Cypress ponds; swamp margins	UCP, LCP; especially southeastern Georgia
<i>Lycium carolinianum</i>	Carolina wolfberry	G4	S1			Coastal sand spits	LCP, Cumberland Island, Camden Co.
<i>Malaxis spicata</i>	Florida adders-mouth orchid	G4?	S1			Low hammocks; spring-fed river swamps	UCP, LCP, potentially over Coastal Plain based on Florida distribution; documented recently only from LCP; historic from UCP in Jenkins Co.
<i>Matelea alabamensis</i>	Alabama milkvine	G2	S1		T	Open bluff forests; mesic margins of longleaf pine sandridges	UCP, LCP; on Gulf CP and an area of Atlantic CP along the Altamaha River, Wayne Co..
<i>Matelea pubiflora</i>	Trailing milkvine	G3G4	S2		R	Exposed sandy soils; sandridges	UCP, LCP
<i>Myriophyllum laxum</i>	Lax water-milfoil	G3	S2		T	Bluehole spring runs; shallow, sandy, swift-flowing creeks; clear, cool ponds	UCP, in many watersheds, most often in westcentral Georgia sandhills
<i>Orbexilum virgatum</i>	Slender leather-root	G1	SH			Sandridges	LCP, Charlton Co.
<i>Oxypolis ternata</i>	Savanna cowbane	G3	S2			Wet pine savannas and bogs	UCP, widely scattered
<i>Peltandra sagittifolia</i>	Arrow arum	G3G4	S2?			Swamps; wet hammocks on pristine sphagnum mats	UCP, LCP; locally abundant in Okefenokee Swamp
<i>Penstemon dissectus</i>	Cutleaf beardtongue	G2	S2?		R	Altamaha Grit outcrops and adjacent pine savannas; rarely sandridges	UCP, endemic to Altamaha Grit (Tifton Uplands)

Table A.2: High Priority Plant Species Found in Coastal Georgia
(Source: WRD, 2005)

Scientific Name	Common Name	Global Rank	State Rank	Federal Status	State Status	Habitat in Georgia	Range in Georgia
<i>Phaseolus polystachios</i> var. <i>sinuatus</i>	Trailing bean-vine	G4T3?	S2?			Sandhills; dry pinelands and hammocks	UCP, LCP
<i>Physostegia leptophylla</i>	Tidal marsh obedient-plant	G4?	S2S3		T	Freshwater tidal marshes; perhaps disjunct in wet savannas of extreme SW Georgia	LCP, coastal cos. on tidally influenced shorelines; reports from UCP in SW Georgia need verification
<i>Plantago sparsiflora</i>	Pineland plantain	G3	S2			Open, wet pine savannas; shallow ditches	UCP, LCP
<i>Platanthera blephariglottis</i> var. <i>blephariglottis</i>	White fringed-orchid	G4G5T4?	S1?				
<i>Platanthera blephariglottis</i> var. <i>conspicua</i>	Southern white fringed-orchid	G4G5T3T4	S2?			Bogs, seeps, roadsides, wet savannas	UCP, LCP; scattered from Fall Line Sandhills to coast and South Georgia plantations
<i>Platanthera chapmanii</i>	Chapman's fringed-orchid	G4?	S1			Open, wet meadows; pine flatwoods	UCP, LCP, extreme Southeast Georgia; historic in Southwest Georgia
<i>Platanthera integra</i>	Yellow fringeless orchid	G3G4	S2			Wet savannas, pitcherplant bogs	UCP, LCP; documented from 9 cos., scattered on coastal plain
<i>Polygonum glaucum</i>	Sea-beach knotweed	G3	SH			Coastal beaches in dune depressions and among protected accumulations of beach wrack	LCP
<i>Portulaca biloba</i>	Grit portulaca	G1G2	S1			Altamaha Grit outcrops	UCP
<i>Pteroglossaspis ecristata</i>	Wild coco	G2	S1			Grassy saw palmetto barrens; longleaf pine grasslands, sometimes with <i>Schwalbea americana</i>	LCP, UPC; widely scattered, including barrier islands
<i>Ptilimnium</i> sp. 1	Mock bishop-weed	G1	SH			Tidal freshwater marshes	LCP, narrow endemic from Savannah into South Carolina
<i>Rhynchospora breviseta</i>	Short-bristle beakrush	G3G4	SU			Bogs; flatwoods	Uncertain, documentation needed, UCP, LCP
<i>Rhynchospora decurrens</i>	Decurrent beakrush	G3G4	S1?			Swamps	UCP, LCP
<i>Rhynchospora fernaldii</i>	Fernald's beakrush	G3G4	SR			Flatwoods depressions	LCP (only?), to be considered as a rarity from Okefenokee Swamp, whence all specimens from Georgia came
<i>Rhynchospora macra</i>	Many-bristled beakrush	G3	S1?			Peaty, sandhill seepage slopes; streamhead pocosins	LCP an old record from Coffee Co. near Douglas
<i>Rhynchospora pleiantha</i>	Clonal thread-leaved beakrush	G2	SH			Margins of limesink depression ponds (dolines)	UCP
<i>Rhynchospora punctata</i>	Spotted beakrush	G1?	S1?			Wet savannas, pitcherplant bogs	UCP, LCP

Table A.2: High Priority Plant Species Found in Coastal Georgia
(Source: WRD, 2005)

Scientific Name	Common Name	Global Rank	State Rank	Federal Status	State Status	Habitat in Georgia	Range in Georgia
<i>Ruellia noctiflora</i>	Night-blooming wild petunia	G2	SH			Open, slash pine flatwoods	LCP, outer Coastal Plain on the Barrier Island Sequence
<i>Sageretia minutiflora</i>	Climbing buckthorn	G4	S1?		T	Calcareous bluff forests; maritime forests over shell mounds	UCP, LCP
<i>Sagittaria graminea</i> var. <i>chapmanii</i>	Chapman's arrowhead	G5T3?	S3?			Low woods and seasonal wet swamps with <i>Carex leptalea</i> , <i>Rhynchospora miliacea</i>	UCP, LCP, perhaps widespread, including a pond on Sapelo Island
<i>Sapindus saponaria</i>	Soapberry	G5	S1			Shell mound forests	LCP
<i>Sarracenia flava</i>	Yellow flytrap	G5?	S3S4		U	Wet savannas, pitcherplant bogs	UCP, LCP
<i>Sarracenia minor</i> var. <i>minor</i>	Hooded pitcherplant	G4T4	S4			Wet savannas, pitcherplant bogs	UCP LCP
<i>Sarracenia minor</i> var. <i>okefenokeense</i>	Okefenokee giant	G4T2T3	S2S3			Wet savannas, pitcherplant bogs	LCP, Okefenokee Basin only
<i>Sarracenia psittacina</i>	Parrot pitcherplant	G4	S2S3		T	Wet savannas, pitcherplant bogs	UCP, LCP
<i>Sarracenia rubra</i>	Sweet pitcherplant	G3	S2	(PS)	E	Atlantic white cedar swamps; wet savannas	UCP, in two areas, Atlantic Coastal Plain and Fall Line Sandhills west of Macon
<i>Schoenolirion elliotii</i>	White sunnybell	G3	S1?			Wet savannas	LCP, few observations from Wayne and Brantley Cos.
<i>Scutellaria altamaha</i>	Altamaha skullcap	G2G3	S1?			Sandy, deciduous woods	UCP, LCP. (only?), perhaps adjacent Piedmont, of Southeast Georgia
<i>Scutellaria arenicola</i>	Sandhill skullcap	G3G4	SH			Sandy scrub	LCP, Trail Ridge; Camden Co.
<i>Scutellaria mellichampii</i>	Mellichamp's skullcap	G?Q	S1?			Sandy deciduous woods	LCP, UCP; widely scattered
<i>Sideroxylon</i> sp. 1	Dwarf buckthorn	G3Q	S3			Dry longleaf pine woods with oak understory; often hidden in wiregrass	UCP, LCP
<i>Sideroxylon thornei</i>	Swamp buckthorn	G2	S2		E	Forested limesink depressions; calcareous swamps	UCP, LCP
<i>Sphagnum cyclophyllum</i>	Round-leaved peat-moss	G3	S2			CP: bare sand where wet or submerged for part of the year and then drying, as around seasonal ponds in pine barrens.. PD: seepage over granite outcrops	PD, LCP, UCP
<i>Spiranthes floridana</i>	Florida ladies-tresses	G1	S1?				
<i>Sporobolus pinetorum</i>	Pineland dropseed	G3	S2?			Wet savannas with wiregrass	LCP

Table A.2: High Priority Plant Species Found in Coastal Georgia
(Source: WRD, 2005)

Scientific Name	Common Name	Global Rank	State Rank	Federal Status	State Status	Habitat in Georgia	Range in Georgia
<i>Stewartia malacodendron</i>	Silky camellia	G4	S2		R	Along streams on lower slopes of beech-magnolia or beech-basswood-Florida maple forests	PD, UCP
<i>Tillandsia bartramii</i>	Bartram's airplant	G4	S2				
<i>Vaccinium crassifolium</i>	Evergreen lowbush blueberry	G4G5	SH			Open margins of Carolina bays	LCP, historically in or near Screven Co.
<i>Xyris drummondii</i>	Drummond's yellow-eyed grass	G3	S1			Pine flatwoods	UCP, LCP
<i>Xyris scabrifolia</i>	Harper's yellow-eyed grass	G3	S1			Sedge bogs; pitcherplant bogs; pine flatwoods	UCP, LCP

Table A.3: High Priority Habitat Areas Found in Coastal Georgia
(Source: WRD, 2005)

Priority Habitat Area	Description
Alluvial (Brownwater) Rivers and Swamps	Large, low-gradient, meandering rivers with sandbars, sloughs and extensive floodplain swamps. Floodplains of these systems may remain inundated for extensive periods. Sand and silt are the dominant substrata and these rivers typically carry heavy sediment loads. Dominant canopy trees are baldcypress and tupelo gum; the understory tree/shrub vegetation may be patchy, often consisting of swamp privet, water elm, swamp dogwood, red maple and Carolina ash. Cypress and gum-dominated swamps can be found along the Altamaha, Savannah and Ogeechee rivers. These systems have been impacted by altered flows from upstream dams.
Barrier Island Freshwater Wetlands and Ponds	Usually found in broad flats or in elliptical to linear interdune depressions on Georgia's coastal barrier islands. These wetland habitats are variable in physiognomy and species composition; deeper, more permanently flooded ponds often have a large extent of open water; shallower ponds are usually dominated by a combination of submergent, emergent and/or floating macrophytes. Trees or shrubs are present mainly along the edges of the ponds. These habitats have been impacted by groundwater withdrawals, fire suppression and invasive exotic plants such as Chinese tallow tree.
Bayheads and Titi Swamps	Forested wetlands dominated by broad-leaved evergreen trees: sweetbay, redbay and loblolly bay. Usually found in domed peatlands, broad interstream flats, or shallow drainageways. Includes shrubby areas dominated by titi (<i>Cyrilla racemiflora</i>). These are considered late successional communities in a variety of hydrogeomorphic settings in the Coastal Plain.
Beech-Magnolia Slope Forests	These are uncommon Coastal Plain hardwood forests, typically found on very mesic river bluffs, and occasionally on gentle slopes that are naturally protected from fire by topographic setting. In addition to American beech and southern magnolia, may contain water oak, water hickory, American holly and other fire-intolerant species. Often small in extent and occupying a narrow zone between wetland and fire-maintained upland forests. May contain epiphytic species such as green-fly orchid. Often associated with and in close proximity to hillside seeps.
Bottomland Hardwood Forests	Diverse hardwood-dominated forests found on natural levees, upper floodplain flats and terraces along brownwater and blackwater rivers. Characterized by a diverse canopy of hardwood species dominated by various oaks, green ash, sweetgum, red maple, water hickory and other mesic species. These extensive forested systems provide habitat for a wide variety of wildlife species, and are especially important for wide-ranging forest interior species. Bottomland hardwood forests have been impacted by altered hydrologic conditions, forest conversion and invasive exotic species.
Brackish Marsh and Salt Marsh	Salt marshes are salt-tolerant grasslands, dominated by cordgrasses and rushes, over soils with circumneutral pH. These are extremely productive habitats. Brackish marshes occupy a wide ecotonal zone in the vicinity of river mouths.
Canebrakes	Thickets of native river cane found along rivers and creeks under sparse to full tree cover. Canebrakes represent important wildlife habitat for a variety of neotropical birds and insects. These habitats require periodic fire or other form of disturbance for maintenance.
Coastal Beaches and Sand Bars	Beaches and sand bars are dynamic, high-energy intertidal systems that represent important habitat for shorebirds and sea turtles. Longshore movement of sand on barrier islands results in erosion at the north end and building up at the south end. These unvegetated habitats are important foraging areas for coastal shorebirds; sea turtles nest in the foredunes at the upper ends of sandy beaches.
Coastal Dunes and Bluffs	These habitats consist of sparsely vegetated sandy interdunes, rear dunes and bluffs. They constitute important habitats for a number of high priority species adapted to harsh temperatures and salt spray. Coastal dune habitats include a number of important microhabitats such as interdune meadows and depressions, shrub thickets and dune scrub forests. Similar vegetation can be found along eroded or exposed coastal bluffs.
Coastal Scrub-Shrub Wetlands	Shrub dominated estuarine communities found along the upper border of salt marsh or brackish marsh. These habitats are infrequently flooded by tidal action and form ecotones between wetland and terrestrial environments. Typical shrubs include groundsel tree, marsh elder, yaupon holly, wax myrtle, Florida privet and false willow. Wind-pruned redcedar may also be present.

Table A.3: High Priority Habitat Areas Found in Coastal Georgia
(Source: WRD, 2005)

Priority Habitat Area	Description
Estuarine and Inshore Marine Waters	Estuaries (brackish waters between barrier islands and mainland) and near-shore ocean waters. Estuaries serve as nurseries for many species of fish and shellfish as well as habitats for manatees and other marine mammals. Species composition in these aquatic communities is influenced by tidal regime and salinity.
Evergreen Hammocks and Mesic Hardwood Forests	Evergreen hammocks are typically associated with small isolated uplands within a floodplain or depressional wetland. Protected from frequent fire, these habitats are characterized by a canopy of submesic oaks and hickories, with southern magnolia, American holly, ironwood, flowering dogwood and spruce pine. Mesic hardwood forests are similar, and may occur in terraces above bottomland hardwood forests, ravines, or nonalluvial flats protected from frequent fire.
Forested Depressional Wetlands	Seasonally or semi-permanently flooded forests of depressional features in broad interstream flats. Soils range from mineral to organic and canopy dominants may include bays, pondcypress and/or pond pine. Fire plays a role in maintaining some of these systems. Isolated wetlands that do not support fish populations are very important breeding habitats for amphibians such as the flatwoods salamander.
Freshwater "Prairies"	Semipermanently flooded freshwater wetlands dominated by emergent vegetation and floating macrophytes, with scattered cypress, buttonbush and swamp blackgum. The primary example in this region is the Okefenokee Swamp. Fluctuations in water levels and/or periodic fire are required for maintenance. Many of these habitats have been impacted by altered hydrology (impoundment with dams or drainage) and/or fire suppression.
Hillside Seeps	Small patch habitats found on moist to wet lower slopes in sandy terrain. These seeps represent natural groundwater discharge points. May be dominated by shrubs or herbs (including pitcherplants), with scattered trees such as pond, slash, or longleaf pine. Most Georgia examples are fire-suppressed.
Longleaf Pine-Scrub Oak Woodlands	Sparse-canopied xeric longleaf pine system with patchy oak understory composed of turkey oak, sand post oak, bluejack oak, blackjack oak and other scrub oak species. Typically found on deep sand soils, on ridges and upper slopes. Contains a fairly diverse groundlayer of xerophytic grasses and forbs and scattered shrubs.
Longleaf Pine-Wiregrass Savannas	Large patch or matrix upland habitats characterized by a sparse canopy of longleaf pine (sometimes with slash pine) and a diverse herb layer dominated by wiregrass. Can range from mesic to dry, depending on topographic position and soils. Transition downslope into wet pine savannas, pine flatwoods, or other wetlands. These habitats are heavily dependent on frequent fire for maintenance.
Maritime Forest and Coastal Hammocks	Coastal forests dominated by live oak and palmetto; hammocks are small islands of maritime forest usually surrounded by brackish water and/or salt marsh. These are restricted to a narrow band of shoreline and barrier islands. Characterized by sandy soils and wind-pruned canopy trees. Provide important habitat for neotropical migrant birds.
Mud and Sand Flats	Periodically inundated mud and sand deposits located in estuarine or inshore marine waters. These unvegetated habitats are generally covered at high tide and exposed at low tide. They serve as important feeding areas for a number of coastal shorebirds such as plovers, sandpipers and dowitchers.
Nonalluvial (Blackwater) Rivers and Swamps	Large, meandering rivers with tea-stained, but translucent waters and narrow to wide floodplains. Dominant substrate is sand, which may form bars in larger systems. In contrast to blackwater streams, forest canopy may only shade a portion of the stream width. Runs and pools are dominant habitats. Large snags are a significant component of habitat heterogeneity. Limestone shoals occur on some of these rivers.
Offshore Marine Waters	Georgia's offshore marine waters provide habitat for a number of high priority species, including loggerhead, green, Kemp's ridley and leatherback turtles, North Atlantic right whales and bottlenose dolphins. Hard-bottom areas are especially important habitats for marine fish and sessile organisms.
Open-Water Ponds and Lakes	Open water aquatic habitats ranging from isolated depressions to impoundments created by beaver. Vegetation is sparse and consists primarily of emergent and floating macrophytes. These habitats are relatively uncommon in this region, and are maintained by periodic fire and fluctuating water levels.

Table A.3: High Priority Habitat Areas Found in Coastal Georgia
(Source: WRD, 2005)

Priority Habitat Area	Description
Pine Flatwoods	Mesic or wet forests on flat, poorly-drained areas of the lower Coastal Plain. Dominated formerly by longleaf pine, now typically by slash pine, occasionally with loblolly or pond pine. Contains a well-developed shrub layer consisting of saw palmetto, gallberry, lowbush blueberry and other ericaceous species. One of the most extensive and prevalent habitats of this ecoregion.
Tidal Rivers and Freshwater Tidal Marsh	Includes tidally influenced portions of rivers and creeks and associated wetlands. Freshwater tidal marshes are wetlands found along the margins of tidal rivers and creeks above the brackish water zone, typically dominated by giant cutgrass, sawgrass, pickerel weed, wild rice, cattail, rushes and a variety of other herbs.
Wet Pine Savannas, Herb and Shrub Bogs	Wet pine savannas are poorly drained wetlands with open to sparse canopies dominated by longleaf, slash and/or pond pine. The shrub layer may be sparse, consisting mainly of gallberry, wax myrtle and blueberries. The herbaceous layer is often diverse and dense, dominated by grasses, sedges, composites, orchids and lilies. May include small peat-filled depressions dominated by titi and other shrubs or by herbaceous bog plants.

References

Georgia Department of Natural Resources Wildlife Resources Division (WRD). 2005. *A Comprehensive Wildlife Conservation Strategy for Georgia*. Georgia Department of Natural Resources. Wildlife Resources Division. Social Circle, GA. Available Online: <http://www1.gadnr.org/cwcs/Documents/strategy.html>.

Appendix B Coastal Georgia Rainfall Analysis

B.1 Introduction

Many storm events occur within Georgia's 24-county coastal region over the course of a given year. Most of these storm events are quite small, but a few can generate several inches of rainfall or more. A Rainfall Frequency Spectrum (RFS) analysis can be used to illustrate how often, on average, each of these various precipitation events can be expected to occur. This Appendix presents RFS analyses for six communities that are distributed across the Coastal Nonpoint Source Management Area and Area of Special Interest: Brooklet, Brunswick, Douglas, Folkston, Jesup and Savannah.

The RFS analyses presented in this Appendix were created using 30 years of historical rainfall data collected in each of the six communities. These analyses illustrate that small, but frequent storm events account for a majority of the storm events that occur in the 24-county coastal region. In fact, as the analyses show, storm events up to and including the 1.2 inch rainfall event account for, on average, 85 percent of all the rainfall events that occur in coastal Georgia.

The RFS analyses also illustrate that these small, but frequent storm events are also responsible for a majority of the stormwater runoff volumes (and pollutant loads) that are generated on development sites located within the 24-county coastal region. As shown by the RFS analyses, the 1.2 inch storm event (and the first 1.2 inches of all larger storm events) accounts for, on average, 82.7 percent of the total rainfall that occurs in coastal Georgia over any given period of time.

B.2 Rainfall Frequency Spectrum (RFS) Analyses

RFS analyses for the communities of Brooklet, Brunswick, Douglas, Folkston, Jesup and Savannah are provided below.

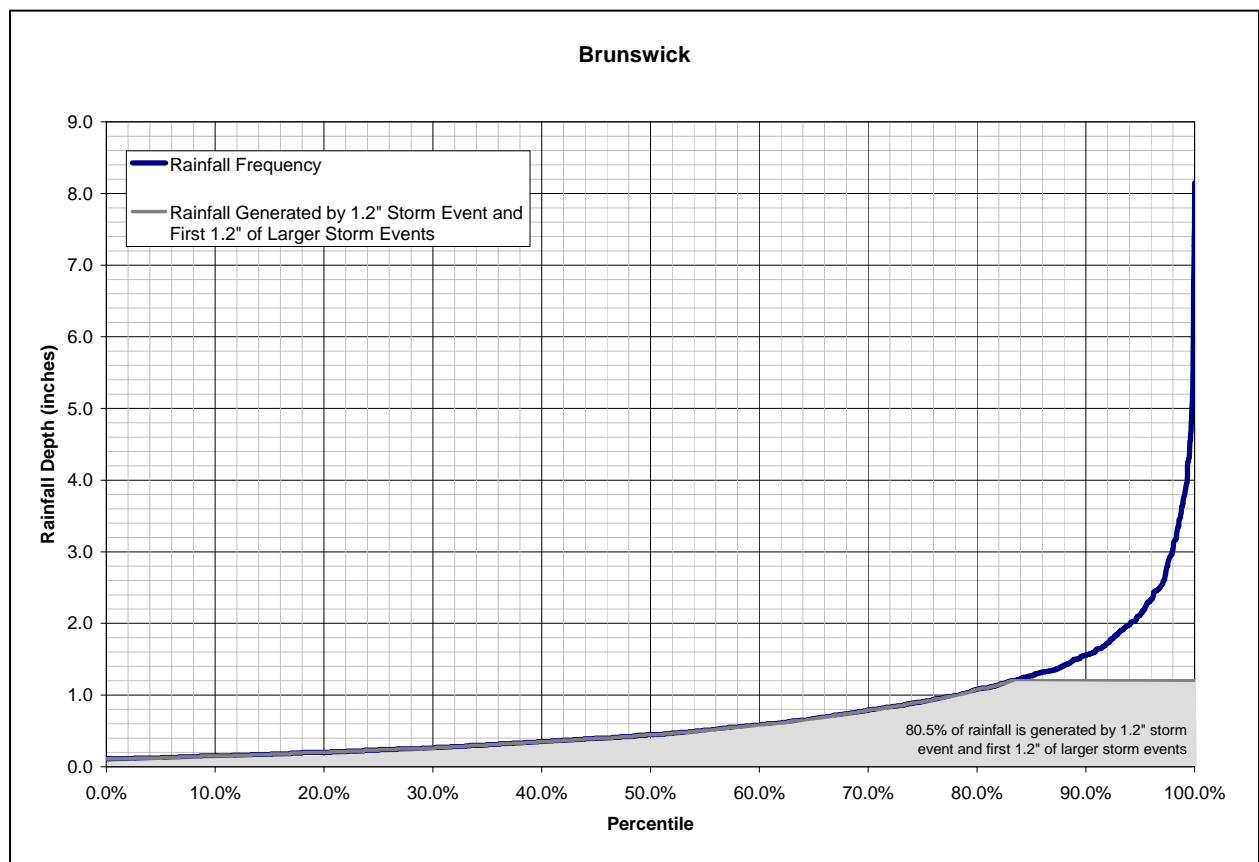
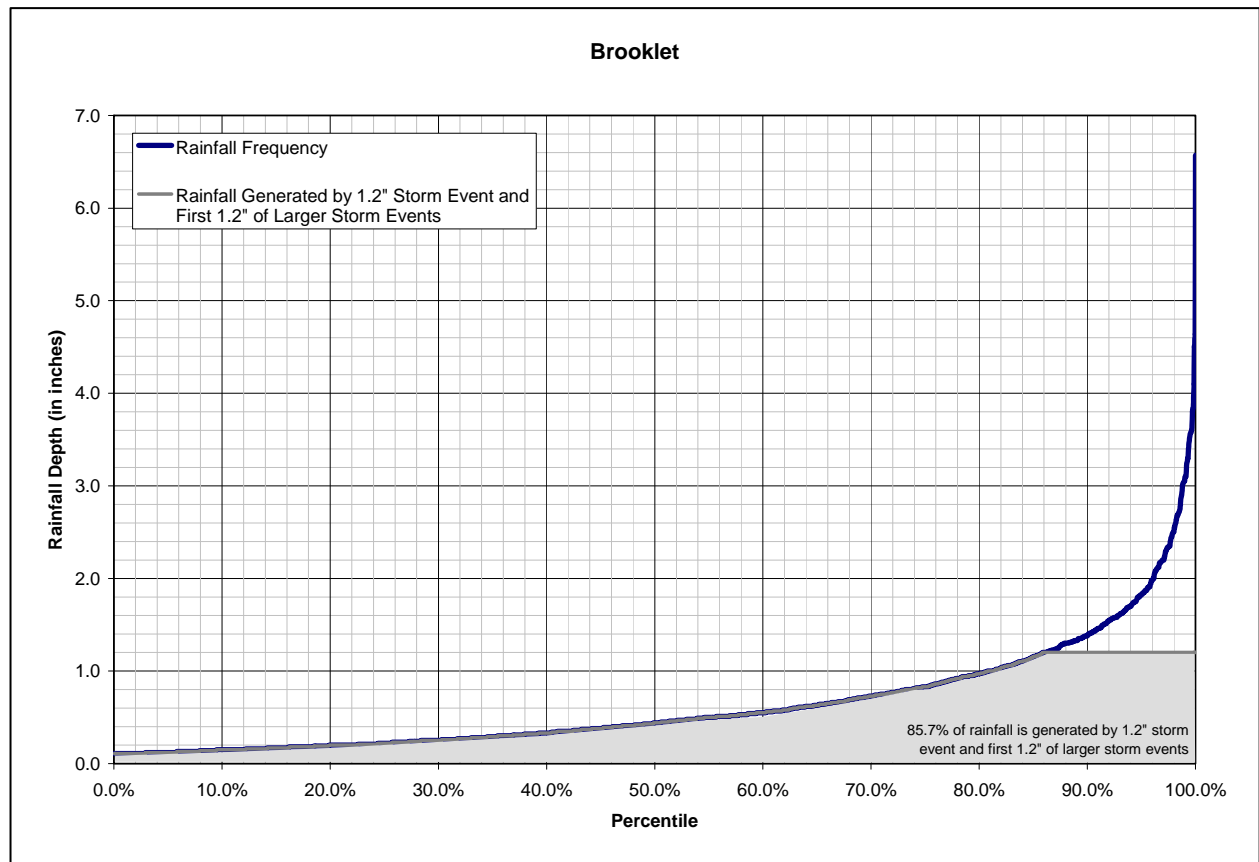

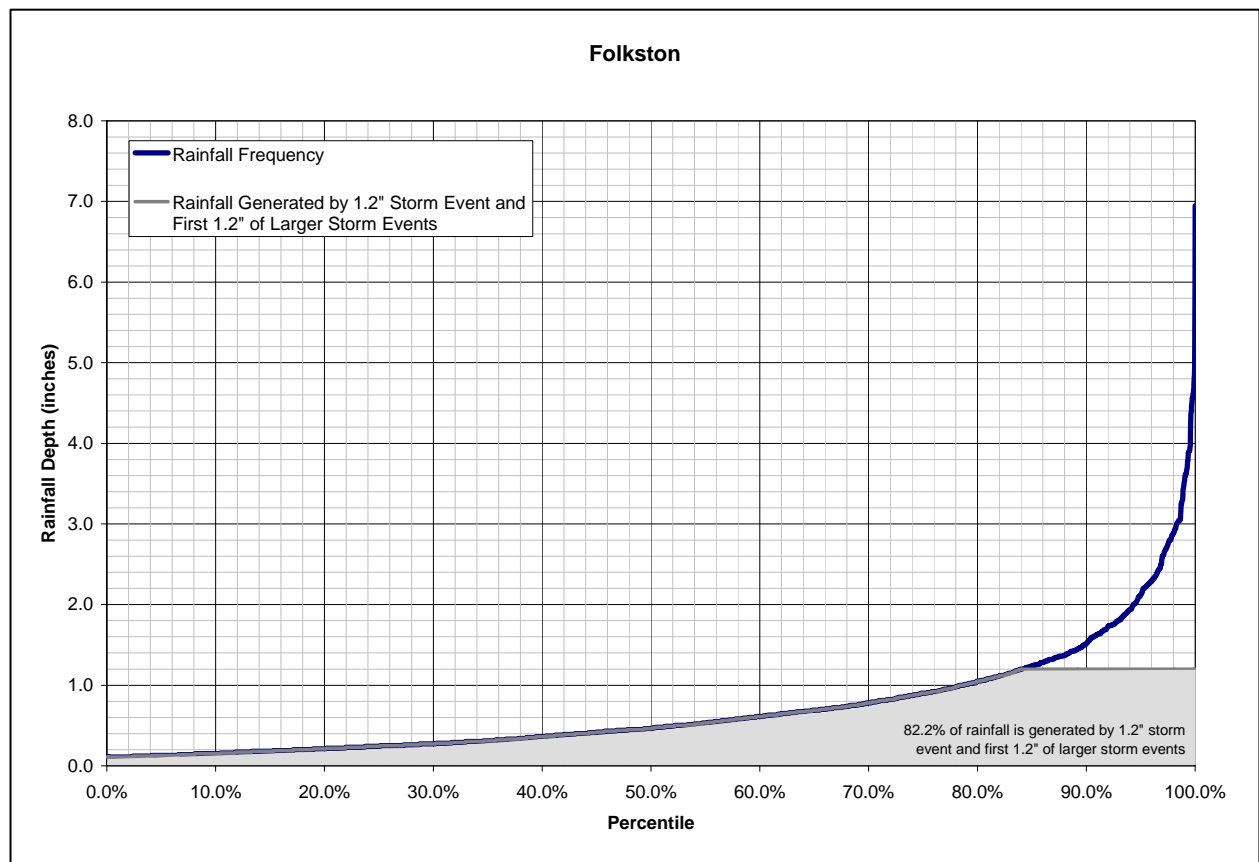
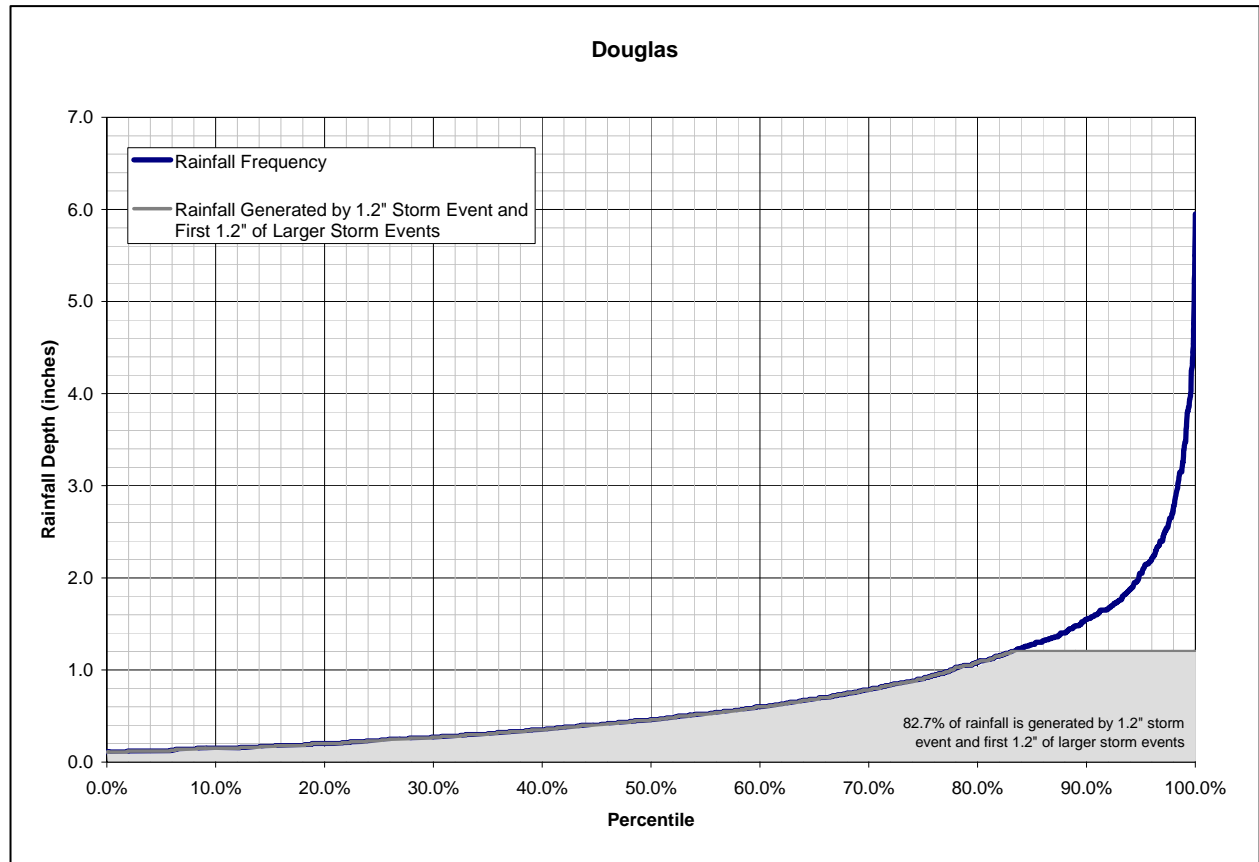

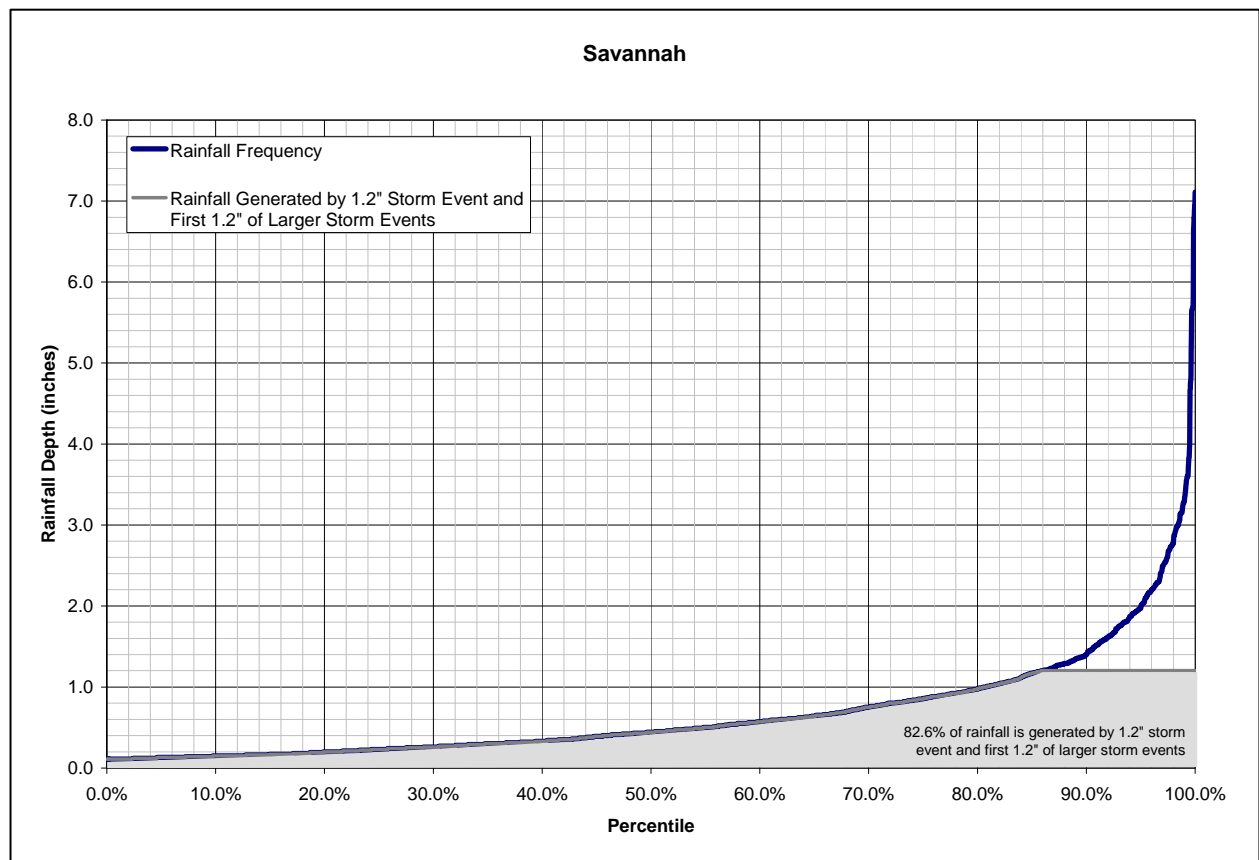
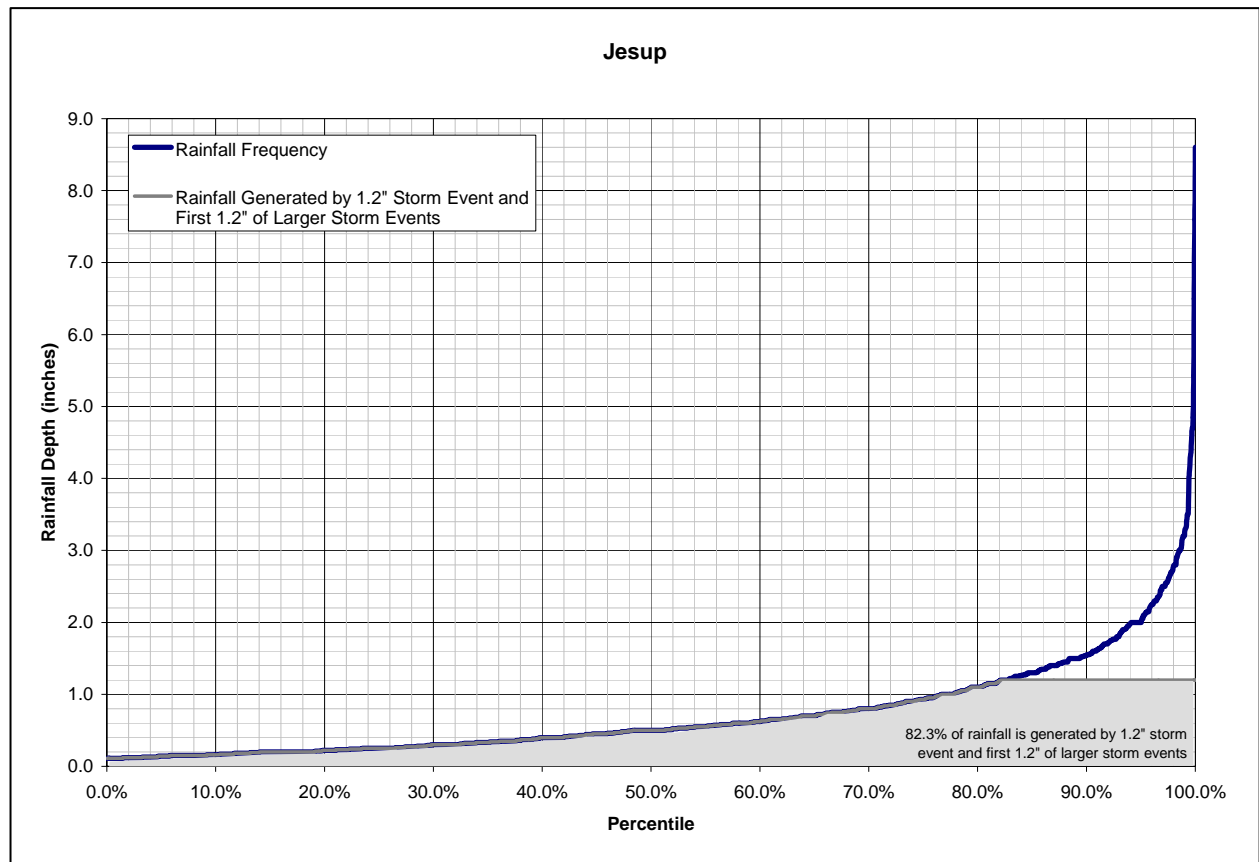

Appendix C Coastal Stormwater Management Practice Monitoring Protocol

This monitoring protocol provides information that can be used to evaluate the performance of green infrastructure and stormwater management practices in coastal Georgia. The protocol presents a simple, yet comprehensive monitoring approach that can be used to accurately evaluate the performance of a wide range of green infrastructure and stormwater management practices.

C.1 Introduction

On a national level, the need to monitor the performance of both green infrastructure and stormwater management practices is often overlooked. Given their widespread use and acceptance, the ability of green infrastructure and stormwater management practices to manage post-construction stormwater runoff rates, volumes and pollutant loads is rarely questioned. However, performance monitoring should be conducted to confirm that these practices are indeed protecting both on-site and downstream aquatic resources from the negative impacts of the land development process.

Currently, there are two primary sources of information on stormwater management practice performance. These include the *National Pollutant Removal Performance Database* (CWP, 2007), which summarizes 166 individual stormwater management practice performance studies, and the *International Stormwater Best Management Practice (BMP) Database* (WWE and Geosyntec, 2008), which contains information on the performance of over 300 individual stormwater management practices. Although these two databases contain a significant amount of data, several groups of green infrastructure and stormwater management practices are not well represented in either of them, including bioretention areas, infiltration practices and many other low impact development practices. Additionally, much of the information contained in the two databases was collected from sites located outside of the coastal plain (Novotney, 2007). Performance monitoring can be conducted in coastal Georgia to help fill both of these data gaps.

Keep in mind that no single monitoring effort can, by itself, be used to define performance of a stormwater management practice. However, it can contribute to the growing body of research on these practices, which will help define their effectiveness in protecting coastal Georgia's valuable aquatic resources from the impacts of the land development process. The results of individual monitoring efforts can also be used to improve the way that green infrastructure and stormwater management practices are designed and maintained.

C.1.1 What Stormwater Management Issues Can Monitoring Address?

Monitoring data collected from green infrastructure and stormwater management practices can be used to:

- Document the performance of commonly used practices
- Document the performance of new or innovative practices
- Document the effectiveness of these practices in removing local pollutants of concern (e.g., total suspended solids, nitrogen, bacteria) from post-construction stormwater runoff
- Evaluate whether or not certain design features (e.g., aquatic benches, vegetated forebays) improve performance
- Evaluate how local conditions (e.g., tidal influences, high groundwater) influence performance

- Determine whether or not the performance of the green infrastructure and stormwater management practices used in the coastal plain differs from the performance of practices used in other physiographic regions
- Provide a scientific basis for future modification or revision of this Coastal Stormwater Supplement (CSS)

C.2 Monitoring Program Development

Figure C.1 illustrates a process that can be used to develop a stormwater management practice monitoring program. Additional information about each step in this process is provided below.

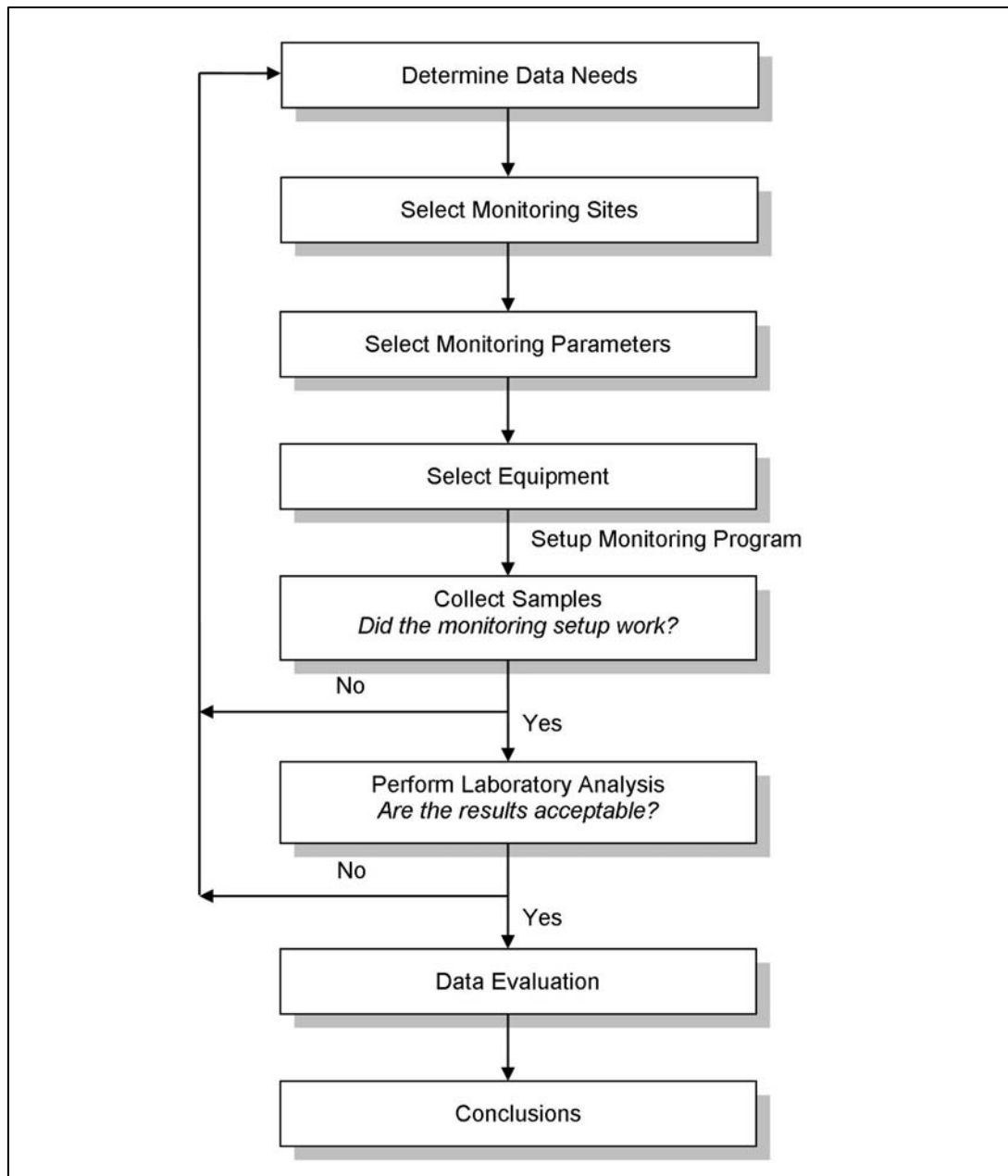

Figure C.1: Developing a Stormwater Management Practice Monitoring Program

(Source: Center for Watershed Protection)

C.2.1 Determining Data Needs

The monitoring program should be designed to collect the data necessary to produce a statistically valid measurement of performance. The amount and type of data that needs to be collected varies according to the method that will be used to evaluate the performance of the stormwater management practice. The two methods most commonly used are the mass efficiency method (also known as the *summation of loads* method) and the event mean concentration efficiency method (also known as *efficiency ratio* method). Table C.1 provides additional information about each of these methods.

Table C.1: Methods Used to Measure Stormwater Management Practice Performance		
Method	Calculation	Data Needs
Mass Efficiency	$[(SOL_{in} - SOL_{out}) \div (SOL_{in})] \times 100$	Precipitation, Inflow, Outflow, Pollutant Concentrations
Event Mean Concentration Efficiency	$[(Conc_{in} - Conc_{out}) \div (Conc_{in})] \times 100$	Precipitation, Pollutant Concentrations
Notes: SOL = sum of pollutant loads Conc = average pollutant event mean concentration		

Of the two methods, the mass efficiency method is recommended because it is generally considered to be more accurate than the event mean concentration method. The mass efficiency method also allows for a mass balance to be performed, which accounts for the stormwater runoff reduction and pollutant load removal provided by the green infrastructure or stormwater management practice.

Although the mass efficiency and event mean concentration efficiency methods are the two methods most commonly used to measure stormwater management practice performance, under certain conditions, they can result in over or underestimation of actual performance. For example, data collected from a stormwater management practice receiving inflow with a very high concentration of a given pollutant (e.g., total suspended solids) may show that the practice provides very good removal of that pollutant (on a percentage basis). However, the outflow from that same stormwater management practice may still contain an unacceptably high concentration of that particular pollutant (Strecker et al., 2004).

Conversely, data collected from a stormwater management practice that receives inflow with a very low concentration of a given pollutant (e.g., total nitrogen) may show that the practice is not performing very effectively (on a percentage basis). This is particularly true when the influent concentration of a particular pollutant approaches its irreducible concentration, which is the lowest possible concentration of a pollutant that can be observed in the field. Irreducible concentrations are dependent on the physical and chemical properties of each pollutant and often result from the pollutant production that occurs internally within a stormwater management practice (e.g., suspended solids and nutrients produced by decaying plant matter). When influent pollutant concentrations approach irreducible values, it becomes very difficult to further reduce the amount of those pollutants through stormwater treatment. In that case, it may be more useful to monitor the performance of a stormwater management practice relative to the achievable level of treatment (Schueler, 2000, ASCE and US EPA, 2002).

How Much Data Is Needed?

Measurements of stormwater management practice performance are only valid if a sufficient number of samples are collected and used in the measurement. The number of samples that

need to be collected to produce statistically valid measurements of performance can be determined based on the pollutant of interest. In general, the more that the concentration of a particular pollutant varies from sample to sample and the smaller the difference between inflow and outflow concentrations, the greater the number of samples that must be collected to produce valid measurements of performance. As more samples are collected, the uncertainty associated with each of the individual samples is reduced and more statistically valid performance measurements of performance can be produced (Burton and Pitt, 2002).

Table C.2 shows the number of samples needed to characterize the performance of a stormwater management performance, with a 95 percent confidence level, based on the difference between mean inflow and outflow concentrations, typical sample concentrations (e.g., coefficient of variation of about 1) and a power of 80 percent. As can be seen from the table, if a high level of confidence is required (a 95 percent confidence level is typically used) and the difference between the mean inflow and outflow concentrations is small, a significant sampling effort will be needed. This could require a multi-year monitoring program.

Table C.2: Number of Samples Needed to Characterize the Performance of a Stormwater Management Practice Based on the Difference in Mean Inflow and Mean Outflow Concentrations (confidence level = 95%, power = 80%, coefficient of variation = 1)

Difference in Sample Set Means	80%	60%	40%	20%
# Samples Needed	20	50	75	300

Prior to initiating a monitoring program, some criteria should be established for determining when the monitoring results will be deemed statistically significant and when additional monitoring will be required. Once the number of samples required to produce a statistically valid measurement of performance has been determined, an iterative process may be needed to re-scope the monitoring effort to remain within budget and on schedule. When scoping a monitoring effort, it is reasonable to expect to collect between 5-10 paired storm event samples per year.

What Storm Events Should Be Sampled?

Consideration should not only be given to the number of samples that are needed to produce statistically valid measurements of performance, but also to the storm events that will need to be sampled. Ideally, samples would be collected during a variety of storm events with a range of intensities and durations in order to evaluate the performance of the stormwater management practice over a wide range of conditions (ASCE and US EPA, 2002). Although small rainfall events occur frequently in coastal Georgia (Appendix B) and can be used to quickly build the data set, they should not be overemphasized in the monitoring program (Burton and Pitt, 2002). A number of paired samples should be collected during larger, less-frequent rainfall events (e.g., 1-year, 24-hour storm, 10-year, 24-hour storm) to better characterize the performance of the stormwater management practice over a wider range of storm events. Historical rainfall data should be investigated to help determine a monitoring approach that might be used to evaluate practice performance over a wide range of storm events.

C.2.2 Selecting Monitoring Sites

The selection of good monitoring sites is an important step in developing a meaningful monitoring program. Selecting good monitoring sites will help ensure that the monitoring program stays on schedule and on budget and that enough samples will be collected to produce statistically significant measurements of performance.

When selecting monitoring sites, it is important to take into account the availability of existing monitoring data and the overall objectives of the monitoring program. A preliminary list of potential monitoring sites can be generated based on these considerations. Where there is an overall lack of local monitoring data, it may be better to select monitoring sites that will allow the performance of commonly used green infrastructure and stormwater management practices to be evaluated. Where new or innovative practices are being put in the ground, it may be better to select monitoring sites that will allow the performance of these practices to be evaluated. Regardless of the type of green infrastructure or stormwater management practice that will be monitored, it is always better to select monitoring sites that have characteristics that are representative of local conditions, rather than sites that have unique or unusual characteristics. This allows the results to be applied on a larger geographical basis, rather than just on the individual monitoring site.

Once a preliminary list of potential monitoring sites has been generated, each of the sites should be assessed using a set of basic screening factors. A set of potential screening factors is provided in Table C.3.

Table C.3: Potential Monitoring Site Screening Factors

- Type of Stormwater Management Practice
- Site Characteristics
- Stormwater Management Practice Design Features
- Complexity of Monitoring Situation
- Watershed Location
- Availability of Existing Monitoring Data
- Existing water quality criteria and designated use information
- Existing 303(d) impairments
- Existing Total Maximum Daily Load (TMDLs)
- Site Accessibility
- Site Safety
- Availability of Electricity
- Space to Install Equipment
- Property Ownership

At a minimum, the site screening process should consider the availability of existing monitoring data, the types of stormwater management practices installed at each potential monitoring site, the characteristics of each potential monitoring site and whether or not the stormwater management practices installed at each potential monitoring site were designed and constructed in accordance with the information presented in this CSS or an equivalent stormwater management manual. If a stormwater management practice was not well designed, it may be better to select another monitoring site; it is simply impractical to monitor a poorly-designed stormwater management practice, as the monitoring data will not provide any insights into the performance of that particular type of practice.

Another factor that should be considered during the site screening process is the complexity of the monitoring situation at each potential monitoring site. Although a monitoring program can be designed for both simple and complex monitoring situations (Table C.4), the design of a monitoring program for a simple monitoring situation tends to be less complicated than the design of a monitoring program for a complex one. Complex monitoring situations often require special sample collection procedures and devices (Table C.5), which increases the complexity of the monitoring program.

Monitoring Situation	Description
Simple Monitoring Situation (e.g., wet pond)	<ul style="list-style-type: none"> Flow into and out of the stormwater management practice occurs at defined inlet and outlet structures and can be effectively characterized by sampling at the inlet and outlet.
Complex Monitoring Situation (e.g., bioretention areas, dry swales)	<ul style="list-style-type: none"> Flow into or out of the stormwater management practice is distributed and cannot be effectively characterized by sampling at the inlet and outlet. Flow must be redirected and concentrated at the inlet or outlet or additional sampling points must be established.

Another important factor to consider during the site screening process is the location of the potential monitoring site within the watershed. Selected monitoring sites can be spread across a large geographical area to permit comparisons from one monitoring site to the next or can be focused in a single priority area. The decision on whether to conduct a broad-based or focused monitoring program typically depends on the overall objectives of the monitoring program.

The site screening process may require both desktop and field investigations and can take some time to complete. Typically, only a small number of potential monitoring sites (e.g., 5 to 10%) will satisfy the screening criteria, so patience is certainly needed when conducting the site screening and selection process.

C.2.3 Selecting Monitoring Parameters

Typical monitoring parameters include:

- Nitrogen
- Phosphorus
- Total Suspended Solids (TSS)
- Biochemical Oxygen Demand (BOD)
- Fecal Coliform
- E. Coli
- Copper
- Lead
- Zinc
- Fats, Oils and Greases (FOG)
- Hydrocarbons

Some communities in the Coastal Nonpoint Source Management Area and Area of Special Interest may already be required to sample for one or more of these parameters. For example, due to National Pollutant Discharge Elimination System (NPDES) Stormwater Program requirements, Chatham County, which is a regulated Municipal Separate Storm Sewer System (MS4) community, is required to sample for BOD, TSS, nitrogen, phosphorus, copper, lead, zinc, FOG, fecal coliform and organic compounds. The selection of local monitoring parameters should take into account any pertinent permit requirements, existing monitoring data, existing resources, the overall objectives of the monitoring program and the local pollutants of concern. In coastal Georgia, the primary pollutants of concern are total suspended solids, nitrogen and bacteria (Novotney, 2007). If possible, these parameters should be monitored as a part of any monitoring program initiated in coastal Georgia.

C.2.4 Selecting Equipment

The equipment needed to collect samples and generate monitoring data on precipitation, inflow and outflow and pollutant concentrations (Table C.1) includes: rain gauges, flow meters, automated samplers and sample bottles. A digital camera is also recommended for photographic documentation of a monitoring site. If monitoring is to be conducted during cold weather months, snow gauges are also recommended to measure any precipitation that may occur in the form of snowfall. Rain and snow gauges should be installed as close as possible to the monitoring stations (e.g., inflow and outflow points) because precipitation can be highly variable even within a small geographic area. Manual rain gauges are also recommended to check the accuracy and consistency of different gauges installed on the monitoring site (ASCE and US EPA, 2002).

Automated samplers are recommended for sample collection. They eliminate the need for an operator to be on-site to perform sample collection and allow for the collection of flow-weighted, composite samples. Although an operator will not need to be on-site to collect samples, it is important to keep in mind that routine inspection and maintenance will need to be performed on all automated samplers to help ensure that the equipment will be functioning properly when a storm event does occur (ASCE and US EPA, 2002).

ISCO and American Sigma are two of a number of manufacturers that make automated sampling equipment that can be used to monitor the performance of stormwater management practices. These samplers are specifically designed for sampling stormwater runoff. They have flexible programming capabilities and can be programmed to begin collecting samples when a specific inflow or outflow rate is detected. These samplers can also be equipped with flow meters and rain gauges so that rainfall and flow data can be collected at the same time as water quality data. Many of the newest automated samplers can also be set up to interface with water quality monitoring probes, such as the YSI 6000, which can provide a continuous record of standard water quality parameters, such as temperature, salinity, pH and turbidity. The YSI 6000 can also be used to trigger sample collection when specific water quality conditions are detected in the inflow or outflow stream.

Although automated samplers are recommended for sample collection, it is important to note that they cannot be used to collect bacteria samples. Bacteria samples must be collected using sterile sample cells and must be preserved using ice. Manual collection of bacteria samples is required to ensure that these sample collection and holding procedures are not compromised during sample collection.

Note that even with specialized equipment, it can be difficult to collect water quality samples under complex monitoring situations. Flow into or out of these practices may occur as sheet flow, may be distributed among multiple inflow or outflow points or may occur underground (e.g., infiltration, groundwater interaction). Complex monitoring situations usually require paired site monitoring, where one monitoring site acts as a control and the other acts as a treatment. The variability in the characteristics of the two monitoring sites adds some uncertainty to the monitoring study, but paired site monitoring provides more accurate results for complex situations than a single site approach, where assumptions need to be made concerning any unmonitored and unaccounted for losses. Paired site monitoring can include one site with a stormwater management practice and one without, or it can include two sites with the same type of stormwater management practice as a way to monitor losses that may be difficult to measure or account for on a single site. Additional options for collecting samples under complex monitoring situations are presented in Table C.5.

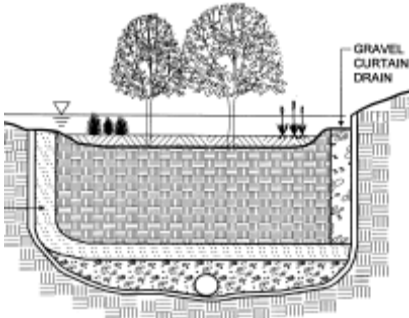
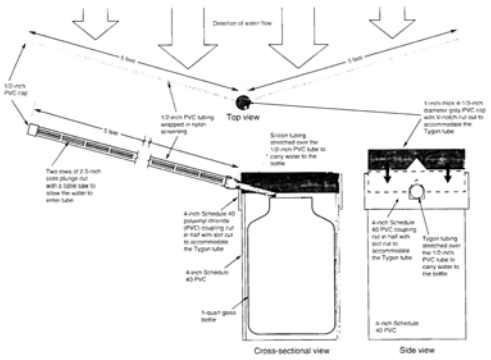

Table C.5: Options for Collecting Samples Under Complex Monitoring Situations	
Option	Description
<p style="text-align: center;">Sump and Weir</p>  <p style="text-align: center;">Source: Smith et al. (No Date)</p>	<p>Install a defined sump and weir at the inflow or outflow point to collect and measure runoff that would have otherwise entered or exited the stormwater management practice as sheet flow</p>
<p style="text-align: center;">Underdrain</p>  <p style="text-align: center;">Source: Claytor and Schueler (1996)</p>	<p>Install an underdrain to collect and measure runoff that would have otherwise exited the stormwater management practice via infiltration</p>
<p style="text-align: center;">Source Area Sampler</p> 	<p>Use source area samplers to collect and measure runoff that would have otherwise entered or exited the stormwater management practice as sheet flow</p>
<p style="text-align: center;">Lysimeter</p>  <p style="text-align: center;">Source: Soilmoisture Equipment (1999)</p>	<p>Use lysimeters or soil water sampling devices to monitor the quality of water within the soil column immediately down gradient of the storm water management practice</p>

Table C.5: Options for Collecting Samples Under Complex Monitoring Situations	
Option	Description
<p>Runoff Estimation</p> $L = [(P)(R_v) \div (12)](C)(A)(2.72)$ <p>Where: L = Pollutant load in influent (pounds) P = Rainfall depth (inches) R_v = Runoff coefficient, which expresses the fraction of rainfall that is converted into runoff C = Event mean concentration of the pollutant in urban runoff (mg/l) A = Area of the contributing drainage (acres) 12 and 2.72 are unit conversion factors</p> <p>Source: Schueler (1987)</p>	<p>Measure outflow and, using the Simple Method, information on pollutant event mean concentrations from the National Stormwater Quality Database and rainfall data, estimate the runoff and pollutant load that entered the stormwater management practice as sheet flow</p>

C.3 Monitoring Procedures

Once monitoring data needs have been determined, monitoring sites and monitoring parameters have been selected and sampling equipment has been purchased, the next step is to set up the monitoring program and begin collecting data. This part of the process is described in more detail below.

C.3.1 Characterize Site Conditions

The characteristics a particular monitoring site will likely have some influence on the performance of the stormwater management practice that is being monitored. For example, the distribution of different land cover types within a stormwater management practice's contributing drainage will influence the type and amount of pollutants that are conveyed into the practice. For this reason, it is important to accurately characterize the site conditions before monitoring begins. The following information should be collected to accurately characterize the conditions of a monitoring site:

- Size of the contributing drainage area
- A narrative description of the contributing drainage area, including information about the different land uses found within
- An estimate of the amount of impervious cover found within the contributing drainage area
- A basic characterization of the pollutants conveyed to the green infrastructure or stormwater management practice
- An narrative history of the stormwater management practice, including information about its age, maintenance history and current condition
- As-built drawings to identify the design features (e.g., forebay, aquatic benches) that were included in the stormwater management practice

C.3.2 Select Monitoring Points

Monitoring stations should be established at the points where flow enters and exits the stormwater management practice. This facilitates a comparison of the quality of the stormwater runoff that is entering and exiting the practice. This comparison can be completed using either the mass efficiency method or the event mean concentration efficiency method (Table C.1). While selecting monitoring points is fairly straightforward in simple monitoring situations, selecting monitoring points in complex monitoring situations is more difficult. Complex monitoring situations typically require a specialized monitoring setup (Table C.4).

Accurate measurement of the flow into and out of the stormwater management practice is important. Inaccurate measurement of inflow or outflow is the single largest source of error in efforts to monitor the performance of individual stormwater management practices. It is important to note that, as the complexity of the monitoring situation increases, so does the difficulty in obtaining accurate measurements of both inflow and outflow.

C.3.3 Collect Samples

Data should be collected to satisfy the needs of the selected performance measurement method (Table C.1). Automated sampling is recommended because it eliminates the need for an operator to be on-site for sample collection and allows for the collection of flow-weighted, composite samples. Samples should be collected throughout the duration of each individual storm event, rather than for specified periods at the very beginning of each event. This is due to the fact that the “first flush” effect is not always observed for all monitoring parameters (Maestre et al., 2004) and can vary depending upon site and rainfall characteristics (Strecker et al., 2005). Therefore, it is recommended that samples be collected throughout the duration of each rainfall event and composited on a flow-weighted basis prior to laboratory analysis. These composite samples provide more accurate results than composite samples collected during only the first 30 minutes or 1 hour of a storm event (Maestre et al., 2004).

After the initial sampling and laboratory analyses have been completed, preliminary data evaluation should be completed to determine if the monitoring program is working and providing the necessary data. If not, adjustments can be made to ensure that the program will provide the data necessary to produce statistically valid measurements of stormwater management practice performance.

What Special Sample Collection Procedures Should Be Observed?

Carefully planned and executed sample collection is required to achieve meaningful results. Sample collection and handling does little to alter the in-situ concentrations of many common monitoring parameters but, for others, it can cause significant changes in concentration. For this reason, sample collection and handling protocol should be followed to ensure that laboratory results are representative of the actual conditions found at the monitoring site. Additional information about proper sample collection and handling techniques is provided in *Illicit Discharge Detection and Elimination: A Guidance Manual for Program Development and Technical Assessments* (CWP and Pitt, 2004). The *Stormwater Effects Handbook: A Toolbox for Watershed Managers, Scientists and Engineers* (Burton and Pitt, 2002) is another good resource for information about proper sample collection and handling techniques.

What Sample Collection Problems Can Be Expected?

Sample collection always appears to be easier on paper than it is in real life. Odds are that a number of problems will be encountered as samples are being collected during a monitoring study. Problems commonly encountered when monitoring green infrastructure and stormwater management practices include:

- Sensitive or sticky triggers on automated sampling equipment that cause problems with sample collection
- Extreme weather events, such as extended droughts and tropical storms, that cause damage to sampling equipment and extend the required length of the monitoring study
- Limited capacity of automated sampling equipment that results in samples being collected for only part of a storm event
- Trash and debris loads that cause damage to sampling equipment
- Vandalism that causes damage to sampling equipment
- Samples that do not account for the total pollutant load contained in either the inflow or outflow, which causes problems when evaluating the sample data

Precautions, such as installing trash racks and other protective measures to prevent equipment damage, can often be taken to address many of these and other common sample collection problems.

C.3.4 Perform Laboratory Analysis

Once they are collected, samples can be analyzed for selected monitoring parameters in-house or at a contract laboratory. The decision on whether to conduct analysis in-house or at a contract laboratory depends upon a number of factors, including the availability of lab space and equipment, staff expertise, staff time, cost, safety considerations and how quickly the sampling results are needed.

C.3.5 Data Evaluation and Management

Once laboratory results are available, they can be used to evaluate the performance of the stormwater management practice using either the mass efficiency method or the event mean concentration efficiency method (Table C.1). Results should not be considered conclusive until a sufficient number of samples have been collected. After conclusive results have been obtained, they should be compared to national (e.g., CWP, 2007) or regional (e.g., data taken only from sites in coastal Georgia) performance data to obtain a sense of how the performance of the practice compares with other similar stormwater management practices.

Paired box and whisker plots of influent and effluent quality are also useful data evaluation tools. Box and whisker plots typically illustrate the median, the 25th and 75th percentiles and the upper and lower 95 percent confidence intervals (Strecker et al., 2004). Figure C.2 presents an example box and whisker plot for the concentration of copper present in the flow into and out of a bioretention area.

Stormwater management practice monitoring can generate a considerable amount of information in a variety of formats. Consequently, both hard copy and electronic information needs to be stored in a manner that will make it easy to be both retrieved and transferred. A central file can be used to house hard copy information, while a single electronic database can be used to house information collected in digital format (ASCE and US EPA, 2002).

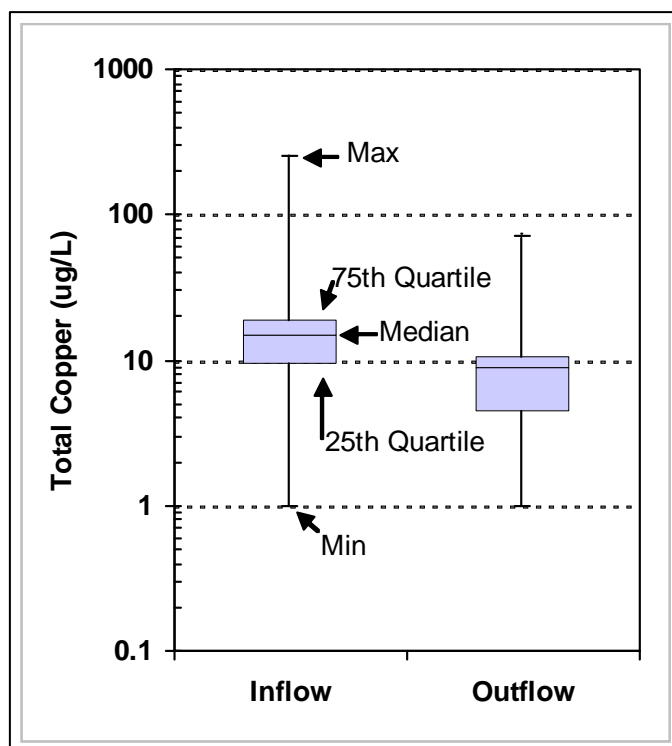

Figure C.2: Example Box and Whisker Plot for a Bioretention Area
(Source: Center for Watershed Protection)

What Data Evaluation and Management Issues Can Be Expected?

Quality control is necessary to ensure that useful and accurate data is collected throughout the duration of the monitoring program. Data should be reviewed as it becomes available to identify any results that may indicate that samples are being incorrectly collected, handled or analyzed. Any questionable results should not be used in the calculations performed to define stormwater management practice performance. Recommended quality controls include checking that the timing on all automated sampling equipment is synchronized, that runoff is entering and exiting the stormwater management practice as expected and that an equivalent number of aliquots are being collected at both the inflow and outflow points during storm events.

Particular attention should be given to “non-detected” values returned from laboratory analyses. These results can present problems during data evaluation.

The detection limit is the lowest concentration of a monitoring parameter that can be measured in the laboratory with a certain degree of confidence. If a parameter is “non-detected” in the laboratory analysis, it means that the concentration of that parameter is less than the detection limit for that parameter. If either a few or many of the observations are below the detection limit, they will not present a serious problem during data analysis. However, if between 25% and 75% of the observations are below the detection limit, statistical data analysis will be severely limited. In this case, it would be better to have the concentrations for all parameters, even if they are below a parameter’s detection limit (Burton and Pitt, 2002).

The amount of stormwater runoff reduction provided by a stormwater management practice should also be estimated when evaluating practice performance. This is perhaps the most

crucial piece of information needed in complex monitoring situations and can be used to confirm that green infrastructure practices are providing the runoff reduction that this CSS “credits” them with providing. Under complex monitoring situations, stormwater runoff volumes usually must be estimated at either the inlet or outlet because flow into or out of these practices may occur as sheet flow, may be distributed among multiple inflow or outflow points or may occur underground (e.g., infiltration, groundwater interaction) and cannot be directly measured.

C.4 Budgeting

An example budget for monitoring an individual stormwater management practice, under both simple and complex monitoring situations, is provided in Table C.6. Keep in mind that the table provides general budgeting guidance and that the total budget for a local monitoring program will vary according to a number of factors, including the length of the monitoring study, the equipment used, local site constraints and the laboratory analysis procedures used.

Table C.6: Example Budget for Monitoring an Individual Stormwater Management Practice						
	Simple Monitoring Situation			Complex Monitoring Situation		
	Staff Time	Unit Cost	Total Cost	Staff Time	Unit Cost	Total Cost
Planning	5%			6%		
Background Research ¹	40 hr	\$50/hr	\$2,000	40 hr	\$50/hr	\$2,000
Desktop Analysis ²	32 hr	\$50/hr	\$1,600	32 hr	\$50/hr	\$1,600
Field Reconnaissance and Site Selection	32 hr	\$50/hr	\$1,600	32 hr	\$50/hr	\$1,600
Site Characterization	8 hr	\$50/hr	\$400	16 hr	\$50/hr	\$800
Monitoring Plan Development	16 hr	\$50/hr	\$800	32 hr	\$50/hr	\$1,600
Subtotal			\$6,400			\$7,600
Implementation	95%			95%		
Equipment ³			\$15,000			\$17,000
Equipment Installation and Maintenance ^{4, 5}	256 hr	\$50/hr	\$12,800	512 hr	\$50/hr	\$25,600
Training	32 hr	\$50/hr	\$1,600	32 hr	\$50/hr	\$1,600
Sample Collection ⁶	512 hr	\$50/hr	\$25,600	512 hr	\$50/hr	\$25,600
Sample Storage and Transport			\$10,000			\$10,000
Laboratory Analysis ⁷		\$200/ea	\$8,800	\$200/ea		\$8,800
Data QA/QC	40 hr	\$50/hr	\$2,000	40 hr	\$50/hr	\$2,000
Data Evaluation and Management	80 hr	\$50/hr	\$4,000	80 hr	\$50/hr	\$4,000
Final Report	80 hr	\$50/hr	\$4,000	80 hr	\$50/hr	\$4,000
Subtotal			\$83,800			\$98,600
Planning and Implementation						
Total			\$90,200			\$106,200
Notes:						
1) Includes determination of data needs, selection of monitoring parameters and preliminary identification of potential monitoring sites						
2) Includes preliminary review of potential monitoring sites and generation of maps for field reconnaissance (major tasks include: preliminary site selection, preliminary site characterization, generate field maps)						

Table C.6: Example Budget for Monitoring an Individual Stormwater Management Practice

Notes:

- 3) Equipment for simple monitoring situation includes 2 automatic samplers, triggering sensors, pump, lumber, concrete, battery, waders, clipboards, fieldbooks, first aid kits; equipment for complex monitoring situation includes 2 automatic samplers, triggering sensors, pump, lumber, concrete, battery, underdrain, sump and weir at inlet, waders, clipboards, fieldbooks, first aid kits
- 4) Installation for simple monitoring situation includes 3 people for 2 days; installation for complex monitoring situation assumes 3 people for 4 days.
- 5) Assumes maintenance burden of 1 person at 2 hours per week for 2 years.
- 6) Includes 2 people for 8 hours for each storm event; assumes 30 storm events and 2 baseflow events will be sampled; out of the 30 sampled events, only 20 are expected to meet QA/QC standards.
- 7) Assumes contract laboratory analysis for nitrogen, phosphorus, total suspended solids, fecal coliform, zinc, lead and hydrocarbons; assumes one composited inflow and one composited outflow sample will be analyzed for 20 storm and 2 baseflow events.

C.5 Alternative Monitoring Methods

As Table C.6 shows, it can be expensive to accurately evaluate the performance of individual green infrastructure and stormwater management practices. Given limited resources, many communities in coastal Georgia will not be able to conduct intensive monitoring on more than a handful of green infrastructure and stormwater management practices. To overcome this constraint, and still collect valuable information about stormwater management practice performance, communities can complete less intense field surveys that evaluate physical indicators of practice performance, such as design features, sediment accumulation and vegetation health.

Although less than a dozen of this type of visual survey have been conducted around the country, they have been extremely valuable in identifying problems with existing stormwater management practice design, as well as in defining new directions for stormwater management practice installation and maintenance. These synoptic surveys are relatively low cost, but can yield important information that can be directly incorporated into local stormwater design guidance, development review procedures and day-to-day operations. Examples of these types of surveys include:

- A study conducted by the U.S. EPA on erosion and sediment control (E&SC) practices at construction sites, in a community thought to have one of the strongest E&SC programs in the nation, found that poor installation and implementation of E&SC practices was a widespread problem (Malcolm et al., 1990)
- Investigations into the pollutant dynamics and habitat quality of stormwater ponds (Campbell, 1995, Leersnyder, 1993, Dewberry and Davis, 1990, Oberts and Osgood, 1988, Bascietto and Adams, 1983).
- Assessments of the failure rate and functional life span of infiltration practices (Galli, 1993, Hilding, 1993).
- Investigations into the performance of biofilters and oil/grit separators (Reeves, 1995, Shepp, 1995).

While these surveys typically only involve visual inspections, they can be supplemented with some water quality sample collection and analysis in an effort to determine whether or not a particular stormwater management practice is working to protect local aquatic resources from the negative impacts of the land development process. Interviews with adjacent residents or property owners can also be used to supplement the results of these visual surveys.

References

- American Society of Civil Engineers (ASCE) and U.S. Environmental Protection Agency (US EPA). 2002. *Urban Stormwater BMP Performance Monitoring: A Guidance Manual for Meeting the National Stormwater BMP Database Requirements*. EPA 821-B-02-001. U.S. Environmental Protection Agency. Washington, DC.
- Bascietto, J. and L. Adams. 1983. "Frogs and Toads of Stormwater Management Basins in Columbia, MD". *Bulletin of MD Herpetological Society*. 19(2): 58-60.
- Burton, A. and R. Pitt. 2002. *Stormwater Effects Handbook: A Toolbox for Watershed Managers, Scientists and Engineers*. Lewis Publishers. New York, NY.
- Campbell, K.R. 1995. "Concentrations of Heavy Metals Associated with Urban Runoff in Fish Living in Stormwater Ponds". *Archives of Environmental Contamination and Toxicology*. 27: 352-356.
- Center for Watershed Protection (CWP). 2007. *National Pollutant Removal Performance Database*. Version 3. Center for Watershed Protection. Ellicott City, MD.
- Center for Watershed Protection (CWP) and R. Pitt. 2004. *Illicit Discharge Detection and Elimination: A Guidance Manual for Program Development and Technical Assessments*. Center for Watershed Protection. Ellicott City, MD.
- Claytor, R. A. and T.R. Schueler. 1996. *Design of Stormwater Filtering Systems*. Center for Watershed Protection. Ellicott City, MD.
- Dewberry and Davis, Inc. 1990. *Toxicity of Sediments from BMP Ponds*. Final Report. Northern Virginia Planning District Commission. Annandale, VA.
- Galli, J. 1993. *Analysis of Urban BMP Performance and Longevity in Prince George's County, Maryland*. Metropolitan Washington Council of Governments. Washington, DC.
- Hilding, K. 1993. *A Study of Infiltration Basins in the Puget Sound Region*. M.E. Thesis. University of California, Davis. Department of Biological and Agricultural Engineering. Davis, CA.
- Leersnyder, H. 1993. *The Performance of Wet Detention Basins for the Removal of Urban Stormwater Contaminants in the Auckland (NZ) Region*. M.S. Thesis. University of Auckland. Department of Environmental Science and Geography. Auckland, NZ.
- Maestre, A., R. Pitt and D. Williamson. 2004. "Nonparametric Statistical Tests Comparing First Flush and Composite Samples from the National Stormwater Quality Database". In: *Models and Applications to Urban Water Systems*. Volume 12. Ed. W. James. Guelph, ON.
- Malcolm, H.R., A.C. Beard, R.J. Burby, E.J. Kaiser, M.I. Luger and R.G. Paterson. 1990. *Evaluation of the North Carolina Erosion and Sediment Control Program*. North Carolina Department of Environmental Health and Natural Resources. Division of Land Resources. Land Quality Section. Raleigh, NC.
- Novotney, M. 2007. *Development of the Coastal Stormwater Supplement (CSS): Phase I*. Technical Memorandum. Center for Watershed Protection. Ellicott City, MD.

- Oberts, G. and R. Osgood. 1988. *Final Report on the Function of the Wetland Treatment Systems and the Impacts on Lake McCarrons*. Publication Number 590-88-095. Metropolitan Council. St. Paul, MN.
- Reeves, E. 1995. "Performance and Condition of Biofilters in the Pacific Northwest". Technical Note 30. *Watershed Protection Techniques*. 1(3): 117-119.
- Schueler, T. 2000. "Irreducible Pollutant Concentrations Discharged from Stormwater Practices". In: *The Practice of Watershed Protection*. Eds. T. Schueler and H. Holland. Center for Watershed Protection. Ellicott City, MD.
- Scheuler, T.R. 1987. *Controlling Urban Runoff: A Practical Manual for Planning and Designing Urban BMPs*. Metropolitan Washington Council of Governments. Washington, DC.
- Shepp, D. 1995. *Petroleum Hydrocarbons in Urban Runoff: A Study Overview*. Prepared for: Maryland Department of the Environment. Metropolitan Washington Council of Governments. Washington, DC.
- Smith, J., B. Hunt and K. Bass. No Date. *Stormwater Best Management Practice (BMP) Monitoring Plan for the City of Charlotte and Mecklenburg County Stormwater Services*. North Carolina State University. Department of Biological and Agricultural Engineering. Raleigh, NC.
- Soilmoisture Equipment Corporation. 1999. *Operating Instructions: 1900 Soil Water Samplers*. Soilmoisture Equipment Corporation. Santa Barbara, CA. Available Online: <http://www.soilmoisture.com/pdf/1900.pdf>.
- Strecker, E., W. Huber, J. Heaney, D. Bodine, J. Sansalone, M. Quigley, M. Leisenring, D. Pankani and A. Thayumanauan. 2005. *Critical Assessment of Stormwater Treatment and Control Selection Issues*. Water Environment Research Foundation.
- Strecker, E., M. Quigley, B. Urbonas and J. Jones. 2004. "Stormwater Management: State-of-the-Art in Comprehensive Approaches to Stormwater". In: *The Water Report: Water Rights, Water Quality and Solutions in the West*. Issue No. 6.
- Wright Water Engineers (WWE) and Geosyntec Consultants (Geosyntec). 2008. *International Stormwater BMP Database*. Available Online: <http://www.bmpdatabase.org/>.

Appendix D Model Post-Construction Stormwater Management Ordinance

This model ordinance addresses the management of post-construction stormwater runoff on development sites. It establishes a set of post-construction stormwater management and site planning and design criteria and permitting procedures and requirements that can be applied to new development and redevelopment activities occurring within the Coastal Nonpoint Source Management Area and Area of Special Interest. It also establishes guidelines for the inspection and maintenance of green infrastructure and stormwater management practices installed on development sites.

This model post-construction stormwater management ordinance is intended to complement and support the information presented in the Coastal Stormwater Supplement (CSS). Communities may adapt the model ordinance “as-is” or may review and modify it to meet more specific local natural resource protection and stormwater management goals and objectives. Additional guidance on using the model post-construction stormwater management ordinance is provided below:

- Summary boxes can be found at the very beginning of each section of the model ordinance. These summary boxes provide a descriptive overview of and additional information about the content that follows.
- Italicized language can be found throughout the model ordinance. This language may be adopted “as-is” or may be modified or removed to suit the specific needs of a community.
- The model ordinance also includes italicized language that is contained in parenthesis to indicate where a community should input more specific information. One example is (*administrator*), which, at the local level, is the person or department responsible for operating the local post-construction stormwater management program.

Table of Contents

1.0	General Provisions	D-5
1.1	Findings of Fact	D-5
1.2	Purpose and Intent	D-6
1.3	Applicability and Exemptions.....	D-7
1.4	Designation of Ordinance Administrator	D-8
1.5	Compatibility with Other Regulations.....	D-8
1.6	Severability.....	D-8
1.7	Stormwater Guidance Manual	D-8
2.0	Definitions.....	D-9
3.0	Permit Procedures and Requirements	D-15
3.1	Permit Application Requirements	D-15
3.2	Stormwater Management Concept Plan.....	D-15
3.3	Consultation Meeting.....	D-17
3.4	Stormwater Management Design Plan.....	D-17
3.5	Stormwater Management System Inspection and Maintenance Agreement and Plan.....	D-19
3.6	Permit Application Procedure.....	D-20
3.7	Application Review Fees.....	D-21
3.8	Performance Bonds.....	D-21
3.9	Compliance Through Off-Site Stormwater Management Practices	D-22
4.0	Post-Construction Stormwater Mangement and Site Planning and Design Criteria	D-23
4.1	Natural Resources Inventory.....	D-23
4.2	Use of Green Infrastructure Practices.....	D-23
4.3	Stormwater Runoff Reduction	D-24
4.4	Water Quality Protection	D-24
4.5	Aquatic Resource Protection	D-25
4.6	Overbank Flood Protection	D-25
4.7	Extreme Flood Protection.....	D-26
4.8	Redevelopment Criteria	D-26
4.9	Green Infrastruture and Stormwater Management Practices	D-27
4.10	Stormwater Conveyance Practices	D-27
5.0	Construction Inspection of Stormwater Management Systems	D-28
5.1	Notice of Construction Commencement	D-28
5.2	Inspections During Construction	D-28
5.3	Final Inspection and As Built Plans	D-29
6.0	Ongoing Inspection and Maintenance of Stormwater Management Systems	D-29
6.1	Maintenance Responsibility.....	D-29
6.2	Maintenance Inspections	D-30
6.3	Records of Maintenance Activities	D-31

6.4	Failure to Maintain.....	D-31
7.0	Violations, Enforcement and Penalties.....	D-31
7.1	Notice of Violation.....	D-31
7.2	Penalties.....	D-32

THIS PAGE INTENTIONALLY LEFT BLANK

1.0 General Provisions

1.1 Findings of Fact

It is hereby determined that:

- (1) The land development process significantly alters the hydrologic response of development sites, increasing stormwater runoff rates, volumes and pollutant loads, and increases flooding, channel erosion and pollutant transport and deposition in rivers and streams;
- (2) The land development process significantly alters the hydrologic response of development sites, increasing stormwater runoff rates, volumes and pollutant loads, and alters water levels and fluctuations and increases pollutant transport and deposition in wetlands;
- (3) The land development process significantly alters the hydrologic response of development sites, increasing stormwater runoff rates, volumes and pollutant loads, and alters salinity concentrations and fluctuations and increases primary productivity and pollutant transport and deposition in estuaries;
- (4) The land development process significantly alters the hydrologic response of development sites, increasing stormwater runoff rates, volumes and pollutant loads, and increases bacteria transport and deposition in near coastal waters, which leads to beach contamination and poses a serious threat to human health;
- (5) The land development process significantly alters the hydrologic response of development sites, increasing stormwater runoff rates and volumes, and decreases the amount of rainfall that is available to recharge shallow groundwater aquifers;
- (6) The negative impacts of the land development process on local aquatic resources can adversely affect the health, safety and general welfare of the general public;
- (7) The negative impacts of the land development process can be controlled and minimized through the management of stormwater runoff rates, volumes and pollutant loads;
- (8) Communities located within Georgia's Coastal Nonpoint Source Management Area and Area of Special Interest are required to comply with a number of state and federal regulations that require the adverse impacts of the land development process to be controlled and minimized;
- (9) Therefore, the (*local jurisdiction*) has determined that it is in the public interest to control and minimize the adverse impacts of the land development process and has established this set of local stormwater management regulations to control post-construction stormwater runoff rates, volumes and pollutant loads on development and redevelopment sites.

1.2 Purpose and Intent

Purpose and Intent

- Most post-construction stormwater management ordinances have a Purpose and Intent section that establishes the reasons that the local jurisdiction is regulating stormwater runoff.
- This section is usually tied to the protection of public health and safety and may also refer to state and/or federal regulatory requirements (e.g., NPDES MS4 permit requirements).

The purpose of this ordinance is to protect and maintain the integrity of local aquatic resources and, consequently, the health, safety and welfare of the general public, by establishing local stormwater management regulations that control and minimize the adverse impacts of the land development process. The ordinance seeks to achieve these goals by:

- (1) Establishing decision-making processes that can be applied during the site planning and design process to help protect the integrity of local aquatic resources;
- (2) Establishing post-construction stormwater management and site planning and design criteria to help protect natural resources from the direct impacts of the land development process and preserve existing hydrologic conditions on development sites;
- (3) Establishing post-construction stormwater management and site planning and design criteria to help reduce flooding, channel erosion and pollutant transport and deposition in local aquatic resources;
- (4) Establishing design guidelines for green infrastructure and stormwater management practices that can be used to meet the post-construction stormwater management and site planning and design criteria;
- (5) Encouraging that green infrastructure practices, which include better site planning techniques, better site design techniques and low impact development practices, be used to the maximum extent practical on development sites;
- (6) Establishing provisions for the long-term inspection and maintenance of green infrastructure and stormwater management practices to ensure that they continue to function as designed and pose no threat to public safety; and,
- (7) Establishing administrative procedures for the submittal, review, approval and disapproval of stormwater management plans and for the inspection of approved development projects.

1.3 Applicability and Exemptions

Applicability and Exemptions

- The Applicability and Exemptions section establishes the “mesh size” for the ordinance; that is, the site size or site characteristics that trigger application of the ordinance and its provisions.
- Applicability can be based on site impervious cover, a land disturbance threshold, overall site size, number of lots and/or the type of development (e.g., stormwater hotspots).
- The most common threshold is one acre of land disturbance. The advantage of this threshold is that it is consistent with the NPDES threshold for construction sites. However, impervious cover is often a more precise trigger for the regulations contained in a post-construction stormwater management ordinance.
- Some local post-construction stormwater management ordinances will have a variable trigger for new development and redevelopment activities, especially if redevelopment is a critical component of an overall land use policy that encourages infill and redevelopment projects.
- The most important consideration regarding exemptions is to identify only those development projects that should not be regulated. Since exemptions categorically exclude activities from the provisions of the ordinance, ordinance language must be clearly written to avoid having well-intentioned exemptions turn into loopholes.

- (1) This ordinance shall be applied to all land disturbing activities, unless exempt pursuant to Section 1.3.2 below. The stormwater management regulations presented within shall be applied to any new development or redevelopment activity that meets one or more of the following criteria:
 - (a) New development that involves the creation of *(5,000 square feet or more)* of impervious cover or that involves other land disturbing activities of *(one acre or more)*;
 - (b) Redevelopment that involves the creation, addition or replacement of *(5,000 square feet or more)* of impervious cover or that involves other land disturbing activities of *(one acre or more)*.
 - (c) New development or redevelopment, regardless of size, that is part of a larger common plan of development, even though multiple, separate and distinct land disturbing activities may take place at different times and on different schedules.
 - (d) New development or redevelopment, regardless of size, that involves the creation or modification of a stormwater hotspot, as defined by the *(administrator)*.
- (2) The following activities are exempt from this ordinance:
 - (a) New development or redevelopment that involves the creation, addition or replacement of *(less than 5,000 square feet)* of impervious cover and that involves *(less than one acre)* of other land disturbing activities.
 - (b) New development or redevelopment activities on individual residential lots that are not part of a larger common plan of development and do not meet any of the applicability criteria listed above.

- (c) Additions or modifications to existing single-family homes and duplex residential units that do not meet any of the applicability criteria listed above.
- (d) Development projects that are undertaken exclusively for agricultural or silvicultural purposes within areas zoned for agricultural or silvicultural land use;
- (e) Maintenance and repairs of any green infrastructure or stormwater management practices deemed necessary by the (*administrator*);
- (f) Any part of a land development project that was approved by the (*administrator*) prior to the adoption of this ordinance; and,
- (g) Redevelopment activities that involve the replacement of impervious cover when the original impervious cover was wholly or partially lost due to natural disaster or other acts of God occurring after (*date of adoption*).

1.4 Designation of Ordinance Administrator

Designation of Ordinance Administrator, Compatibility with Other Regulations, Severability, Stormwater Guidance Manual

- These sections appear in some, but not all, post-construction stormwater management ordinances for various legal reasons.
- Consult with legal staff to determine the applicability of these sections within your local jurisdiction.

The (*administrator*) is hereby appointed to administer and implement the provisions of this ordinance.

1.5 Compatibility with Other Regulations

This ordinance is not intended to interfere with, modify or repeal any other ordinance, rule, regulation or other provision of law. The requirements of this ordinance should be considered minimum requirements, and where any provision of this ordinance imposes restrictions different from those imposed by any other ordinance, rule, regulation or other provision of law, whichever provision is more restrictive or imposes higher protective standards for human health or the environment shall control.

1.6 Severability

If the provisions of any section, subsection, paragraph, subdivision or clause of this ordinance shall be judged invalid by a court of competent jurisdiction, such judgment shall not affect or invalidate the remainder of any section, subsection, paragraph, subdivision or clause of this ordinance.

1.7 Stormwater Guidance Manual

The (*local jurisdiction*) will utilize the information presented in the latest edition of the *Coastal Stormwater Supplement to the Georgia Stormwater Management Manual*, and any relevant local addenda, to assist in the proper implementation of this ordinance. These references may be updated and expanded periodically, based on additional information obtained through scientific research, performance monitoring and local experience.

2.0 Definitions

Definitions

- The Definitions section ensures that terms are defined consistently across other related guidance and regulatory documents.

“Applicant” means a property owner or agent of a property owner who has submitted an application for a post-construction stormwater management permit.

“Aquatic Buffer” means an area of land located around or near a stream, wetland, or waterbody that has intrinsic value due to the ecological services it provides, including pollutant removal, erosion control and conveyance and temporary storage of flood flows.

“Aquatic Resource Protection” means measures taken to protect aquatic resources from several negative impacts of the land development process, including complete loss or destruction, stream channel enlargement and increased salinity fluctuations.

“Better Site Design Techniques” means site design techniques that can be used during the site planning and design process to minimize land disturbance and the creation of new impervious and disturbed pervious cover. Better site design techniques include reducing clearing and grading limits, reducing roadway lengths and widths and reducing parking lot and building footprints.

“Better Site Planning Techniques” means site planning techniques that can be used during the site planning and design process to protect valuable aquatic and terrestrial resources from the direct impacts of the land development process. Better site planning techniques include protecting primary and secondary conservation areas.

“Building” means any structure, either temporary or permanent, having walls and a roof, designed for the shelter of any person, animal or property and occupying more than 100 square feet of area.

“Channel” means a natural or artificial watercourse with a definite bed and banks that conducts continuously or periodically flowing water.

“Conservation Areas” means permanently protected areas of a site that are preserved, in perpetuity, in an undisturbed, natural state.

“Conservation Easement” means a legal agreement between a land owner and a local, state or federal government agency or land trust that permanently protects conservation areas on the owner’s land by limiting the amount and type of development that can take place within them but continues to leave the conservation areas in private ownership.

“Dedication” means the deliberate appropriation of property by its owner for general public use.

“Detention” means the temporary storage of stormwater runoff in a stormwater management practice for the purpose of controlling the peak discharge rates and providing gravitational settling of pollutants.

“Developer” means a person who undertakes a land development project.

“Development Project” means a new development or redevelopment project.

“Development Site” means a parcel of land where land disturbing activities have been or will be initiated to complete a land development project.

“Drainage Easement” means a legal right granted by a land owner to a grantee allowing the grantee to convey, treat or manage stormwater runoff on the private land subject to the drainage easement.

“Easement” means a legal right granted by a land owner to a grantee allowing the use of private land for conveyance, treatment and management of stormwater runoff and access to green infrastructure and stormwater practices.

“Erosion and Sediment Control Plan” means a plan that is designed to minimize and control the accelerated erosion and increased sediment loads that occur at a site during land disturbing activities.

“Evapotranspiration” means the loss of water to the atmosphere through both evaporation and transpiration, which is the evaporation of water from the aerial parts of plants.

“Extended Detention” means the temporary storage of stormwater runoff in a stormwater management practice for an extended period of time, typically 24 hours or greater.

“Extreme Flood Protection” means measures taken to protect downstream properties from dangerous extreme flooding events and help maintain the boundaries of the existing 100-year floodplain.

“Fee in Lieu Contribution” means a payment of money in place of meeting all or part of the stormwater management criteria required by a post-construction stormwater management ordinance.

“Flooding” means a volume of stormwater runoff that is too great to be confined within the banks of a stream, river or other aquatic resource or walls of a stormwater conveyance feature and that overflows onto adjacent lands.

“Green Infrastructure Practices” means the combination of three complementary, but distinct, groups of natural resource protection and stormwater management practices and techniques, including better site planning and design techniques and low impact development practices, that are used to protect valuable terrestrial and aquatic resources from the direct impacts of the land development process, maintain pre-development site hydrology and reduce post-construction stormwater runoff rates, volumes and pollutant loads.

“Hydrologic Soil Group (HSG)” means a Natural Resource Conservation Service classification system in which soils are categorized into four runoff potential groups. The groups range from group A soils, with high permeability and little runoff produced, to group D soils, which have low permeability rates and produce much more runoff.

“Impaired Waters” means those streams, rivers, lakes, estuaries and other water bodies that currently do not meet their designated use classification and associated water quality standards under the Clean Water Act.

“Impervious Cover” means a surface composed of any material that greatly impedes or prevents the natural infiltration of water into the underlying native soils. Impervious surfaces include, but are not limited to, rooftops, buildings, sidewalks, driveways, streets and roads.

“Industrial Stormwater Permit” means a National Pollutant Discharge Elimination System (NPDES) permit issued to an industry or group of industries that regulates the pollutant levels associated with industrial stormwater discharges or specifies on-site pollution control strategies.

“Infill Development” means land development that occurs within designated areas based on local land use, watershed and/or utility plans where the surrounding area is generally developed, and where the site or area is either vacant or has previously been used for another purpose.

“Infiltration” means the process of allowing stormwater runoff to percolate into the underlying native soils.

“Infiltration Practice” means a green infrastructure or stormwater management practice designed to provide infiltration of stormwater runoff into the underlying native soils. These stormwater management practices may be above or below grade.

“Inspection and Maintenance Agreement and Plan” means a written agreement and plan providing for the long-term inspection and maintenance of all green infrastructure practices, stormwater management practices, stormwater conveyance features and stormwater drain infrastructure on a development site.

“Jurisdictional Wetland” means an area that is inundated or saturated by surface water or groundwater at a frequency and duration sufficient to support a prevalence of vegetation typically adapted for life in saturated soil conditions, commonly known as hydrophytic vegetation.

“Land Development” means any project undertaken to change or improve a site that involves one or more land disturbing activities.

“Land Disturbing Activity” means any activity that changes stormwater runoff rates, volumes and pollutant loads on a site. These activities include, but are not limited to, the grading, digging, cutting, scraping, or excavating of soil, the placement of fill materials, paving, construction, substantial removal of vegetation and any activity that bares soil or rock or involves the diversion or piping of any natural or man-made watercourse.

“Land Owner” means the legal or beneficial owner of land, including those holding the right to purchase or lease the land, or any other person holding proprietary rights in the land.

“Low Impact Development Practice” means small-scale stormwater management practices that are used to disconnect impervious and disturbed pervious surfaces from the storm drain system and reduce post-construction stormwater runoff rates, volumes and pollutant loads. Low impact development practices include soil restoration, site reforestation/revegetation, green roofs, vegetated filter strips and rain gardens.

“National Pollutant Discharge Elimination System (NPDES) Stormwater Discharge Permit” means a permit issued by the EPA, or by a State under authority delegated pursuant to 33 USC § 1342(b), that authorizes the discharge of pollutants to waters of the State, whether the permit is applicable on an individual, group, or general area-wide basis.

“New Development” means a land development project undertaken on a previously undeveloped or unimproved site.

“Nonpoint Source Pollution” means pollution from any source other than from a discernible, confined and discrete conveyance, such as a wastewater treatment plant or industrial discharge. Sources of nonpoint source pollution include, but are not limited to, agricultural, silvicultural, mining and construction activities, subsurface disposal and urban stormwater runoff.

“Nonstructural Stormwater Management Practice” means any natural resource protection or stormwater management practice or technique that uses natural processes and natural systems to intercept, convey, treat and/or manage stormwater runoff. Nonstructural stormwater management practices include, but are not limited to, protecting primary and secondary conservation areas, reducing clearing and grading limits, reducing roadway lengths and widths, reducing parking lot and building footprints, soil restoration, site reforestation/revegetation, green roofs, vegetated filter strips and rain gardens.

“Off-Site Stormwater Management Practice” means a green infrastructure or stormwater management practice located outside the boundaries of a development site.

“On-Site Stormwater Management Practice” means a green infrastructure or stormwater management practice located within the boundaries of a development site.

“Overbank Flood Protection” means measures taken to protect downstream properties from damaging overbank flooding events.

“Owner” means the legal or beneficial owner of a piece of land, including, but not limited to, a mortgagee or vendee in possession, receiver, executor, trustee, lessee or other person, firm, or corporation in control of the site.

“Permanent Stormwater Management Practice” means a green infrastructure or stormwater management practice that will be operational after the land disturbing activities are complete and that is designed to become a permanent part of the site for the purposes of managing post-construction stormwater runoff.

“Permit” means the permit issued by a local development review authority to an applicant, which is required for undertaking any land development project or land disturbing activities.

“Person” means any individual, partnership, firm, association, joint venture, public or private corporation, trust, estate, commission, board, public or private institution, utility, cooperative, city, county or other political subdivision, any interstate body, or any other legal entity.

“Post-Development Hydrology” refers to the set of hydrologic conditions that may reasonably be expected to exist on a development site, after the completion of all land disturbing and construction activities.

“Pre-Development Hydrology” refers to the set of hydrologic conditions that exist on a development site prior to the commencement of any land disturbing activities and at the time that plans for the land development project are approved by the local development review authority.

“Receiving Stream” or **“Receiving Aquatic Resource”** means the body of water or conveyance into which stormwater runoff is discharged.

“Recharge” means the replenishment of groundwater aquifers.

“Redevelopment” means a change to previously existing, improved property, including but not limited to the demolition or building of structures, filling, grading, paving, or excavating, but excluding ordinary maintenance activities, remodeling of buildings on the existing footprint, resurfacing of paved areas and exterior changes or improvements that do not materially increase or concentrate stormwater runoff or cause additional nonpoint source pollution.

“Regional Stormwater Management Practice” means a stormwater management practice designed to control stormwater runoff from multiple properties, where the owners or developers of the individual properties may participate in providing land, financing, design services, construction services and/or maintenance services for the practice.

“Responsible Party” means any individual, partnership, co-partnership, firm, company, corporation, association, joint stock company, trust, estate, governmental entity, or any other legal entity; or their legal representatives, agents, or assigns that is named on a stormwater inspection and maintenance agreement and plan as responsible for the long-term operation and maintenance of one or more green infrastructure or stormwater management practices.

“Site” means development site.

“Stop Work Order” means an order issued that requires that all land disturbing activity on a site be stopped.

“Stormwater Hotspot” means an area where land use or pollution generating activities have the potential to generate highly contaminated runoff, with concentrations of pollutants in excess of those typically found in stormwater runoff. Stormwater hotspots include, but are not limited to, fueling stations (including temporary fueling stations during construction), golf courses, public works yards and marinas.

“Stormwater Management” means the interception, conveyance, treatment and management of stormwater runoff in a manner that is intended to prevent increased flood damage, channel erosion, habitat degradation and water quality degradation and to enhance and promote the public health, safety and general welfare.

“Stormwater Management Plan” means a written document that details how stormwater runoff will be managed on a development site and that shows how the stormwater management criteria that apply to the development project have been met.

“Stormwater Management Practice” means a practice or technique, either structural or nonstructural, that is used to intercept stormwater runoff and change the characteristics of that runoff. Stormwater management practices are used to control post-construction stormwater runoff rates, volumes and pollutant loads to prevent increased flood damage, channel erosion, habitat degradation and water quality degradation.

“Stormwater Management System” means the entire suite of green infrastructure and stormwater management practices and stormwater conveyance features that are used to intercept, convey, treat and manage stormwater runoff on a development site.

“Stormwater Retrofit” means a green infrastructure or stormwater management practice designed for an existing development site that previously had no green infrastructure or

stormwater management practice in place or had a practice that was not meeting local stormwater management criteria.

“Stormwater Runoff” means surface water resulting from precipitation.

“Stormwater Runoff Reduction” means providing for the interception, evapotranspiration, infiltration, or capture and reuse of stormwater runoff to help maintain pre-development site hydrology and help protect aquatic resources from several indirect impacts of the land development process, including decreased groundwater recharge, decreased baseflow and degraded water quality.

“Subdivision” means the division of a parcel of land to create one or more new lots or development sites for the purpose, whether immediately or in the future, of sale, transfer of ownership, or land development, and includes divisions of land resulting from or made in connection with the layout or construction of a new street or roadway or a change in the layout of an existing street or roadway.

“Watercourse” means a permanent or intermittent stream or other body of water, either natural or man-made, which gathers or carries surface water.

“Watershed Management Plan” or **“Subwatershed Management Plan”** means a document, usually developed cooperatively by government agencies and other stakeholders, to protect, restore and/or otherwise manage the water resources found within a particular watershed or subwatershed. Watershed or subwatershed management plans commonly identify threats, sources of impairment, institutional issues and technical and programmatic solutions or projects to protect and/or restore water resources.

“Water Quality Protection” means adequately treating stormwater runoff before it is discharged from a development site to help protect downstream aquatic resources from water quality degradation.

“Wetland Hydroperiod” means the pattern of fluctuating water levels within a wetland caused by the complex interaction of surface water, groundwater, topography, soils and geology within a wetland.

3.0 Permit Procedures and Requirements

Permit Procedures and Requirements

- The Permit Procedures and Requirements section outlines the requirements for development plan submittal and the general conditions for plan approval.
- Plan approval can be a local jurisdiction's last chance to influence several important issues, such as ensuring long-term access to green infrastructure and stormwater management practices and assigning ongoing maintenance responsibility.
- The ordinance should establish the plan review and approval process as a mechanism to secure an inspection and maintenance agreement and plan that will ensure the long-term viability of green infrastructure and stormwater management practices.

3.1 Permit Application Requirements

No owner or developer shall undertake any development activity without first meeting the requirements of this ordinance and receiving a permit for the proposed development activity from the (*local jurisdiction*). Unless specifically exempted by this ordinance, any owner or developer proposing a development project shall submit to the (*local jurisdiction*) a permit application on a form provided by the (*local jurisdiction*). Unless otherwise exempted by this ordinance, the following items shall accompany a permit application:

- (1) Stormwater management concept plan prepared in accordance with Section 3.2;
- (2) Record of a consultation meeting held in accordance with Section 3.3;
- (3) Stormwater management design plan prepared in accordance with Section 3.4;
- (4) Stormwater management system inspection and maintenance agreement and plan prepared in accordance with Section 3.5;
- (5) Permit application and plan review fees prepared in accordance with Sections 3.6 and 3.7; and,
- (6) *Performance bond prepared in accordance with Section 3.8.*

3.2 Stormwater Management Concept Plan

Prior to the preparation and submittal of a stormwater management design plan and permit application, the owner or developer shall submit to the (*local jurisdiction*) for review and approval, a stormwater management concept plan illustrating the layout of the proposed development project and showing, in general, how post-construction stormwater runoff will be managed on the development site.

The stormwater management concept plan shall include the following information:

- (1) Project Narrative: The project narrative shall include a vicinity map, the common address of the development site and a legal description of the development site.
- (2) Site Fingerprint: The site fingerprint shall illustrate the results of the natural resources inventory (Section 4.1), which is used to identify and map the natural resources found on the development site, as they exist prior to the start of any land disturbing activities.

-
- (3) Existing Conditions Map: The existing conditions map shall include all of the information shown on the site fingerprint and shall illustrate:
- (a) Existing roads, buildings, parking areas and other impervious surfaces;
 - (b) Existing utilities (e.g., water, sewer, gas, electric) and utility easements;
 - (c) Existing primary and secondary conservation areas;
 - (d) Existing low impact development and stormwater management practices;
 - (e) Existing storm drain infrastructure (e.g., inlets, manholes, storm drains); and,
 - (f) Existing channel modifications (e.g., bridge or culvert installations).
- (4) Proposed Conditions Map: The proposed conditions map shall illustrate:
- (a) Proposed topography (minimum two-foot contours recommended);
 - (b) Proposed drainage divides and patterns;
 - (c) Proposed roads, buildings, parking areas and other impervious surfaces;
 - (d) Proposed utilities (e.g., water, sewer, gas, electric) and utility easements;
 - (e) Proposed limits of clearing and grading;
 - (f) Proposed primary and secondary conservation areas;
 - (g) Proposed low impact development and stormwater management practices;
 - (h) Proposed storm drain infrastructure (e.g., inlets, manholes, storm drains); and,
 - (i) Proposed channel modifications (e.g., bridge or culvert installations).
- (5) Post-Construction Stormwater Management System Narrative: The post-construction stormwater management system narrative shall include information about how post-construction stormwater runoff will be managed on the development site, including a list of the low impact development and stormwater management practices that will be used. It shall also include calculations showing how initial estimates of the post-construction stormwater management criteria that apply to the development project were obtained, including information about the existing and proposed conditions of each of the drainage areas found on the development site (e.g., size, soil types, land cover characteristics).

In accordance with Section 4.2, green infrastructure practices (i.e., better site planning techniques, better site design techniques, low impact development practices) shall be used to the maximum extent practical during the creation of a stormwater management concept plan. Green infrastructure practices include, but are not limited to, protecting primary and secondary conservation areas, reducing clearing and grading limits, reducing roadway lengths and widths, reducing parking lot and building footprints, soil restoration, site reforestation/revegetation, green roofs, vegetated filter strips and rain gardens.

3.3 Consultation Meeting

All applicants are encouraged to hold a consultation meeting with the (*local jurisdiction*) to discuss the proposed development project, the stormwater management concept plan and the approach that was used to satisfy the post-construction stormwater management and site planning and design criteria that apply to the development site. This consultation meeting shall take place *on-site* after submittal, but prior to approval, of the stormwater management concept plan, for the purposes of verifying site conditions and the feasibility of the stormwater management concept plan.

3.4 Stormwater Management Design Plan

Subsequent to approval of the stormwater management concept plan, the owner or developer shall submit to the (*local jurisdiction*) for review and approval, a stormwater management design plan that details how post-development stormwater runoff will be controlled or managed on the development site. The stormwater management design plan shall detail how the proposed development project will meet the post-construction stormwater management and site planning and design criteria that apply to the development site.

The stormwater management design plan shall include all of the information contained in the stormwater management concept plan, plus:

- (1) Existing Conditions Hydrologic Analysis: The existing conditions hydrologic analysis shall include:
 - (a) Existing conditions map (Section 3.2.3);
 - (b) Information about the existing conditions of each of the drainage areas found on the development site (e.g., size, soil types, land cover characteristics);
 - (c) Information about the existing conditions of any off-site drainage areas that contribute stormwater runoff to the development site (e.g., size, soil types, land cover characteristics);
 - (d) Information about the stormwater runoff rates and volumes generated, under existing conditions, in each of the drainage areas found on the development site;
 - (e) Information about the stormwater runoff rates and volumes generated, under existing conditions, in each of the off-site drainage areas that contribute stormwater runoff to the development site; and
 - (f) Documentation (e.g., model diagram) and calculations showing how the existing conditions hydrologic analysis was completed.
- (2) Proposed Conditions Hydrologic Analysis: The proposed conditions hydrologic analysis shall include:
 - (a) Proposed conditions map (Section 3.2.4);
 - (b) Information about the proposed conditions of each of the drainage areas found on the development site (e.g., size, soil types, land cover characteristics);

- (c) Information about the proposed conditions of any off-site drainage areas that contribute stormwater runoff to the development site (e.g., size, soil types, land cover characteristics);
 - (d) Information about the stormwater runoff rates and volumes generated, under proposed conditions, in each of the drainage areas found on the development site;
 - (e) Information about the stormwater runoff rates and volumes generated, under proposed conditions, in each of the off-site drainage areas that contribute stormwater runoff to the development site; and
 - (f) Documentation (e.g., model diagram) and calculations showing how the proposed conditions hydrologic analysis was completed.
- (3) Post-Construction Stormwater Management System Plan: The post-construction stormwater management system plan shall illustrate:
- (a) Proposed topography;
 - (b) Proposed drainage divides and patterns;
 - (c) Existing and proposed roads, buildings, parking areas and other impervious surfaces;
 - (d) Existing and proposed primary and secondary conservation areas;
 - (e) Plan view of existing and proposed low impact development and stormwater management practices;
 - (f) Cross-section and profile views of existing and proposed low impact development and stormwater management practices, including information about water surface elevations, storage volumes and inlet and outlet structures (e.g., orifice sizes);
 - (g) Plan view of existing and proposed storm drain infrastructure (e.g., inlets, manholes, storm drains);
 - (h) Cross-section and profile views of existing and proposed storm drain infrastructure (e.g., inlets, manholes, storm drains), including information about invert and water surface elevations; and
 - (i) Existing and proposed channel modifications (e.g., bridge or culvert installations).
- (4) Post-Construction Stormwater Management System Narrative: The post-construction stormwater management system narrative shall include information about how post-construction stormwater runoff will be managed on the development site, including a list of the low impact development and stormwater management practices that will be used. It shall also include documentation and calculations that demonstrate how the selected low impact development and stormwater management practices satisfy the post-construction stormwater management criteria that apply to the development site, including information about the existing and proposed conditions of each of the

drainage areas found on the development site (e.g., size, soil types, land cover characteristics).

- (5) Certification by Plan Preparer: The stormwater management design plan shall be prepared by a certified design professional, such as a landscape architect, professional surveyor or professional engineer, who must certify that the design of the stormwater management system meets the requirements of this ordinance and the latest edition of the *Coastal Stormwater Supplement to the Georgia Stormwater Management Manual*, and any relevant local addenda.
- (6) Certification by Owner: The owner shall certify that all land disturbing and development activities will be completed in accordance with the approved stormwater management design plan.

A copy of the stormwater management concept plan (Section 3.2) shall be included with the submittal of the stormwater management design plan. The stormwater management design plan should be consistent with the stormwater management concept plan. If any significant changes were made to the plan of development, the (*administrator*) may ask for a written statement providing rationale for any of the changes that were made.

3.5 Stormwater Management System Inspection and Maintenance Agreement and Plan

Stormwater Management System Inspection and Maintenance Agreement and Plan

- The Stormwater Management System Inspection and Maintenance Agreement and Plan section is intended to ensure the long-term maintenance of green infrastructure and stormwater management practices installed on a development site. This section should be used to:
 - Ensure that maintenance agreements are recorded.
 - Ensure that easements for maintenance and access are platted.
 - Establish maintenance inspection and reporting requirements.

- (1) Prior to the issuance of a permit for any new development or redevelopment activity that requires one, the applicant or owner of the development site, if different, must execute an inspection and maintenance agreement and plan that shall be binding on all subsequent owners of the site, unless the stormwater management system is dedicated to and accepted by the (*local jurisdiction*).
- (2) The inspection and maintenance agreement and plan shall include the following information:
 - (a) Identification by name or official title the person(s) responsible for carrying out the inspection and maintenance;
 - (b) A statement confirming that responsibility for the operation and maintenance of the stormwater management system, unless assumed by the (*local jurisdiction*), shall remain with the property owner and shall pass to any successive owner;
 - (c) A provision stating that, if portions of the development site are sold or otherwise transferred, legally binding arrangements shall be made to pass responsibility for the operation and maintenance of the stormwater management system to the appropriate successors in title; these arrangements shall designate, for each

- portion of the stormwater management system, the person(s) to be permanently responsible for its inspection and maintenance;
- (d) A maintenance schedule stating when and how often routine inspection and maintenance will occur to ensure proper function of the stormwater management system; and,
 - (e) Plans for annual inspections to ensure proper performance of the stormwater management system between scheduled maintenance activities.
- (3) The inspection and maintenance agreement and plan shall be approved by the *(local jurisdiction)* prior to approval of the stormwater management design plan and recorded with the deed upon approval of the stormwater management design plan.
 - (4) In addition to enforcing the terms of the inspection and maintenance agreement and plan, the *(local jurisdiction)* may also enforce all of the provisions for ongoing inspection and maintenance contained in Section 6.0 of this ordinance.
 - (5) The terms of the stormwater management system inspection and maintenance agreement and plan shall provide for the *(local jurisdiction)* to enter the property at reasonable times and in a reasonable manner for the purpose of inspection. These terms include the right to enter a property when the *(local jurisdiction)* has a reason to believe that a violation of an approved stormwater management system inspection and maintenance agreement and plan has occurred and when necessary for abatement of a public nuisance or correction of a violation of this ordinance or an approved stormwater management system inspection and maintenance agreement and plan.

3.6 Permit Application Procedure

- (1) Applications for permits shall be filed with the *(local jurisdiction)* on a permit application on a form provided by the *(local jurisdiction)*.
- (2) Permit applications shall include the items set forth in Section 3.1. *Two copies of the stormwater management design plan and stormwater management system inspection and maintenance agreement and plan shall be included with the permit application.*
- (3) The *(local jurisdiction)* shall inform the applicant whether the application, stormwater management design plan and inspection and maintenance agreement and plan are approved or disapproved.
- (4) If the permit application, stormwater management design plan or inspection and maintenance agreement and plan are disapproved, the *(local jurisdiction)* shall notify the applicant of that fact in writing. The applicant may then revise any item not meeting the requirements of this ordinance and resubmit the application, in which event Section 3.5.3 shall apply to such re-submittal.
- (5) Upon a finding by the *(local jurisdiction)* that the permit application, stormwater management design plan and inspection and maintenance agreement and plan, if applicable, meet the requirements of this ordinance, the *(local jurisdiction)* may issue a permit for the development project, provided that all other legal requirements for the issuance of such permit have been met.

- (6) Notwithstanding the issuance of the permit, in undertaking the new development or redevelopment activity, the applicant or other responsible person shall be subject to the following requirements:
- (a) The applicant shall comply with all applicable requirements of the approved stormwater management design plan and the provisions of this ordinance and shall certify that all land disturbing and development activities will be completed in accordance with the approved stormwater management design plan;
 - (b) The development project shall be conducted only within the area specified in the approved stormwater management design plan;
 - (c) The *(local jurisdiction)* shall be allowed to conduct periodic inspections of the development project in accordance with Sections 5.0 and 6.0;
 - (d) No changes may be made to an approved stormwater management design plan without review and written approval by the *(local jurisdiction)*; and,
 - (e) Upon completion of the development project, the applicant or other responsible person shall submit a statement certifying that the project has been completed in accordance with the approved stormwater management design plan. The applicant or other responsible person shall also submit as built plans for the stormwater management system, as required under Section 5.3.

3.7 Application Review Fees

Application Review Fees

- The local jurisdiction should insert an appropriate fee schedule into this section of the post-construction stormwater management ordinance.
- If a local jurisdiction does not currently charge fees for plan review, waivers and inspections, then it should consider fees as a possible revenue source for its post-construction stormwater management program.

A non-refundable permit fee *(shall/may)* be collected at the time the permit application is submitted to the *(local jurisdiction)*. Any permit fees that are collected shall be used to support the administration and management of the plan review and approval process and the inspection of all development projects subject to the requirements of this ordinance. The *(local jurisdiction)* *(shall/may)* develop a fee schedule based on the area of land disturbed by the project and may amend the fee schedule from time to time.

3.8 Performance Bonds

The (local jurisdiction) shall require, from the applicant, a surety or cash bond, irrevocable letter of credit or other means of security acceptable to the (local jurisdiction) prior to the issuance of a permit for any new development or redevelopment activity. The amount of the security shall not be less than the total estimated construction cost of the post-construction stormwater management system to be installed on the development site. The bond shall include provisions relative to forfeiture for failure to complete the work specified in the approved stormwater management design plan, compliance with the provisions of this ordinance, other applicable laws and regulations and any time limitations. The bond shall not be fully released without a final inspection of the completed work by the (local jurisdiction), submittal of as built plans, a

recorded inspection and maintenance agreement and plan and certification by the applicant that the stormwater management system complies with the approved stormwater management design plan and the requirements of this ordinance. A procedure may be used to release parts of the bond held by the (local jurisdiction) after various stages of construction have been completed and accepted by the (local jurisdiction). The procedures used for partially releasing performance bonds must be specified by the (local jurisdiction) in writing prior to the approval of a stormwater management design plan.

3.9 Compliance Through Off-Site Stormwater Management Practices

All stormwater management design plans shall include on-site green infrastructure and stormwater management practices, unless arrangements are made with the *(local jurisdiction)* to manage post-construction stormwater runoff in an off-site or regional stormwater management practice. The off-site or regional stormwater management practice must be located on property legally dedicated to that purpose, be designed and sized to meet the post-construction stormwater management criteria presented in Section 4.0 of this ordinance, provide a level of stormwater quality and quantity control that is equal to or greater than that which would be provided by on-site green infrastructure and stormwater management practices and have an associated inspection and maintenance agreement and plan (Section 3.5). In addition, appropriate stormwater management practices shall be installed, where necessary, to protect properties and drainage channels that are located between the development site and the location of the off-site or regional stormwater management practice.

To be eligible for compliance through the use of off-site stormwater management practices, the applicant must submit a stormwater management design plan to the *(local jurisdiction)* that shows the adequacy of the off-site or regional stormwater management practice and demonstrates, to the satisfaction of the *(local jurisdiction)*, that the off-site or regional stormwater management practice will not result in the following impacts:

- (1) Increased threat of flood damage or endangerment to public health or safety;
- (2) Deterioration of existing culverts, bridges, dams and other structures;
- (3) Accelerated streambank or streambed erosion or siltation;
- (4) Degradation of in-stream biological functions or habitat; or,
- (5) Water quality impairment in violation of state water quality standards and/or violation of any other state or federal regulations.

4.0 Post-Construction Stormwater Management and Site Planning and Design Criteria

Post-Construction Stormwater Management and Site Planning and Design Criteria

- Criteria are the core of a post-construction stormwater management ordinance. They establish the design objectives for green infrastructure and stormwater management practices, and will influence the types of practices that are used on a development site.
- Criteria in the ordinance should remain fairly simple, with technical detail relegated to the stormwater guidance manual, which, in this case, is the *Coastal Stormwater Supplement to the Georgia Stormwater Management Manual*.

The following post-construction stormwater management and site planning and design criteria shall be applied to all new development and redevelopment activities that are subject to the provisions of this ordinance. The criteria have been designed to protect valuable local natural resources from the negative impacts of the land development process.

If local natural resource protection and stormwater management goals and objectives warrant greater protection than that provided by the post-construction stormwater management and site planning and design criteria outlined below, the (*local jurisdiction*) may impose additional requirements on new development and redevelopment activities that it has determined are necessary to protect local aquatic and terrestrial resources from the negative impacts of the land development process.

4.1 Natural Resources Inventory

Prior to the start of any land disturbing activities, including any clearing and grading activities, acceptable site reconnaissance and surveying techniques should be used to complete a thorough assessment of the natural resources, both terrestrial and aquatic, found on a development site. The natural resources inventory shall be completed in accordance with the information presented within the latest edition of the *Coastal Stormwater Supplement to the Georgia Stormwater Management Manual*.

The preservation and/or restoration of the natural resources found on a development site, through the use of green infrastructure practices, may, at the discretion of the (*local jurisdiction*), be assigned quantifiable stormwater management "credits" that can be used when calculating the stormwater runoff volumes associated with the post-construction stormwater management criteria outlined in Sections 4.3 through 4.7 of this ordinance. The green infrastructure practices that qualify for these "credits," and information about how they can be used to help satisfy the post-construction stormwater management criteria outlined in Sections 4.3 through 4.7 of this ordinance, is provided in the latest edition of the *Coastal Stormwater Supplement to the Georgia Stormwater Management Manual*.

4.2 Use of Green Infrastructure Practices

Green infrastructure practices shall be used to the maximum extent practical during the creation of a stormwater management concept plan (Section 3.2) for a proposed development project. Green infrastructure practices can be used to not only help protect local terrestrial and aquatic resources from the direct impacts of the land development process, but also to help maintain pre-development site hydrology and reduce post-construction stormwater runoff rates, volumes and pollutant loads.

4.3 Stormwater Runoff Reduction

The stormwater runoff volume generated by the runoff reduction storm event, as defined in the latest edition of the *Coastal Stormwater Supplement to the Georgia Stormwater Management Manual*, shall be reduced on-site in order to help maintain pre-development site hydrology and help protect local aquatic resources from several indirect impacts of the land development process, including decreased groundwater recharge, decreased baseflow and degraded water quality. A stormwater management system is presumed to comply with this criteria if:

- (1) It includes green infrastructure practices that provide for the interception, evapotranspiration, infiltration or capture and reuse of stormwater runoff, that have been selected, designed, constructed and maintained in accordance with the information presented in the latest edition of the *Coastal Stormwater Supplement to the Georgia Stormwater Management Manual* and any relevant local addenda; and,
- (2) It is designed to provide the amount of stormwater runoff reduction specified in the latest edition of the *Coastal Stormwater Supplement to the Georgia Stormwater Management Manual*.

The (*administrator*) may reduce the amount of stormwater runoff reduction needed to satisfy this criteria on development sites that are considered to be stormwater hotspots or that have site characteristics or constraints, such as high groundwater, impermeable soils, contaminated soils or confined groundwater aquifer recharge areas, that prevent the use of green infrastructure practices that provide for the interception, evapotranspiration, infiltration or capture and reuse of stormwater runoff. When seeking a reduction in the amount of stormwater runoff reduction that needs to be provided in order to satisfy this criteria, applicants shall:

- (1) Use green infrastructure practices that provide for the interception, evapotranspiration, infiltration or capture and reuse of stormwater runoff, to provide the minimum amount of stormwater runoff reduction specified in the latest edition of the *Coastal Stormwater Supplement to the Georgia Stormwater Management Manual* and any relevant local addenda; and,
- (2) Provide adequate documentation to the (*local jurisdiction*) to show that no additional runoff reducing green infrastructure practices can be used on the development site.

In accordance with Section 4.4 of this ordinance, any of the stormwater runoff volume generated by the runoff reduction storm event that is not reduced on the development site shall be intercepted and treated in one or more stormwater management practices that provide at least an 80 percent reduction in total suspended solids loads and that reduce nitrogen and bacteria loads to the maximum extent practical.

4.4 Water Quality Protection

In order to protect local aquatic resources from water quality degradation, post-construction stormwater runoff shall be adequately treated before it is discharged from a development site. Applicants can satisfy this criteria by satisfying the stormwater runoff reduction criteria (Section 4.3). However, if any of the stormwater runoff volume generated by the runoff reduction storm event, as defined in the latest edition of the *Coastal Stormwater Supplement to the Georgia Stormwater Management Manual*, cannot be reduced on the development site, due to site characteristics or constraints, it shall be intercepted and treated in one or more stormwater management practices that provide at least an 80 percent reduction in total suspended solids

loads and that reduce nitrogen and bacteria loads to the maximum extent practical. When seeking to satisfy this criteria through the use of one or more stormwater management practices, applicants shall:

- (1) Intercept and treat stormwater runoff in stormwater management practices that have been selected, designed, constructed and maintained in accordance with the information presented in the latest edition of the *Coastal Stormwater Supplement to the Georgia Stormwater Management Manual* and any relevant local addenda; and,
- (2) Provide adequate documentation to the *(local jurisdiction)* to show that total suspended solids, nitrogen and bacteria removal were considered during the selection of the stormwater management practices that will be used to intercept and treat stormwater runoff on the development site.

4.5 Aquatic Resource Protection

In order to protect local aquatic resources from several other negative impacts of the land development process, including complete loss or destruction, stream channel enlargement and increased salinity fluctuations, applicants shall provide aquatic resource protection in accordance with the with the information provided in the latest edition of the *Coastal Stormwater Supplement to the Georgia Stormwater Management Manual*.

4.6 Overbank Flood Protection

Overbank Flood Protection

- Most local jurisdictions establish an overbank flood protection criteria that is matched with the design storm used to design open channels, culverts, bridges and storm drain systems. Consequently, many local jurisdictions require that the peak discharge generated by the 10-year and/or 25-year, 24-hour storm event under post-development conditions be controlled in a manner that ensures that it does not exceed the peak discharge generated by the same storm event(s) under pre-development conditions.

All stormwater management systems shall be designed to control the peak discharge generated by the overbank flood protection storm event, as defined in the latest edition of the *Coastal Stormwater Supplement to the Georgia Stormwater Management Manual*, to prevent an increase in the duration, frequency and magnitude of downstream overbank flooding. A stormwater management system is presumed to comply with this criteria if it is designed to provide overbank flood protection in accordance with the information provided in the latest edition of the *Coastal Stormwater Supplement to the Georgia Stormwater Management Manual*.

The *(administrator)* may modify or waive this criteria on development sites where both the on-site and downstream stormwater conveyance systems are designed to safely convey the peak discharge generated by the overbank flood protection storm event to a receiving stream, tidal creek or other aquatic resource without causing additional downstream flooding or other environmental impacts, such as stream channel enlargement or degradation of habitat.

4.7. Extreme Flood Protection

Extreme Flood Protection

- Some local jurisdictions establish an extreme flood protection criteria to maintain the boundaries of existing floodplains, reduce the threat of flooding and protect public health and safety. Even if an extreme flood protection criteria is not established, local jurisdictions should require that all green infrastructure and stormwater management practices that impound stormwater runoff can safely pass the 100-year storm without overtopping or creating damaging or dangerous downstream conditions.

All stormwater management systems shall be designed to control the peak discharge generated by the extreme flood protection storm event, as defined in the latest edition of the *Coastal Stormwater Supplement to the Georgia Stormwater Management Manual*, to prevent an increase in the duration, frequency and magnitude of downstream extreme flooding and protect public health and safety. A stormwater management system is presumed to comply with this criteria if it is designed to provide extreme flood protection in accordance with the information provided in the latest edition of the *Coastal Stormwater Supplement to the Georgia Stormwater Management Manual*.

The (*administrator*) may modify or waive this criteria on development sites where both the on-site and downstream stormwater conveyance systems are designed to safely convey the peak discharge generated by the extreme flood protection storm event to a receiving stream, tidal creek or other aquatic resource without causing additional downstream flooding or other environmental impacts, such as stream channel enlargement or degradation of habitat.

4.8 Redevelopment Criteria

Redevelopment Criteria

- Include a separate Redevelopment Criteria section when the local jurisdiction wants to encourage redevelopment as part of a greater land use planning or Smart Growth strategy.
- With these criteria, post-construction stormwater management requirements are tailored to the unique conditions of redevelopment projects. These criteria may include less rigorous post-construction stormwater management requirements or provisions for off-site mitigation in lieu of full on-site compliance.
- In some local jurisdictions, redevelopment projects may be required to meet more rigorous stormwater management criteria if downstream flooding and/or water quality are important local issues.

Development activities that are considered to be redevelopment activities shall meet at least one of the following criteria:

- (1) **Reduce Impervious Cover:** Reduce existing site impervious cover by at least 20%.
- (2) **Provide Stormwater Management:** Manage the stormwater runoff from at least 20% of the site's existing impervious cover and any new impervious cover in accordance with the post-construction stormwater management criteria outlined in Sections 4.3 through 4.7 of this ordinance. The green infrastructure and stormwater management practices used to comply with these criteria shall be selected, designed, constructed and maintained in accordance with the information presented in the latest edition of the

Coastal Stormwater Supplement to the Georgia Stormwater Management Manual and any relevant local addenda.

- (3) **Provide Off-Site Stormwater Management:** *Provide, through the use of off-site stormwater management practices, a level of stormwater quality and quantity control that is equal to or greater than that which would be provided by satisfying the post-construction stormwater management criteria outlined in Sections 4.3 through 4.7 of this ordinance on the development site.*
- (4) **Combination of Measures:** *Any combination of (1) through (3) above that is acceptable to the (local jurisdiction).*

4.9 Green Infrastructure and Stormwater Management Practices

All green infrastructure and stormwater management practices shall be selected, designed, constructed and maintained in accordance with the information presented in the latest edition of the *Coastal Stormwater Supplement to the Georgia Stormwater Management Manual* and any relevant local addenda. Applicants are referred to the latest edition of the *Coastal Stormwater Supplement to the Georgia Stormwater Management Manual*, and any relevant local addenda, for guidance on selecting green infrastructure and stormwater management practices that can be used to satisfy the post-construction stormwater management criteria outlined in Sections 4.3 through 4.7 of this ordinance.

For green infrastructure or stormwater management practices that are not included in the *Coastal Stormwater Supplement to the Georgia Stormwater Management Manual*, or for which pollutant removal and runoff reduction rates have not been provided, the effectiveness of the green infrastructure or stormwater management practice must be documented through prior studies, literature reviews or other means, and receive approval from the *(local jurisdiction)* before being included in a stormwater management system.

4.10 Stormwater Conveyance Practices

Stormwater conveyance practices, which may include, but are not limited to, storm drain pipes, culverts, catch basins, drop inlets, junction boxes, headwalls, gutters, ditches, open channels, swales and energy dissipaters, shall be provided when necessary to convey post-construction stormwater runoff and protect private properties adjoining development sites and/or public rights-of-way. Stormwater conveyance practices that are used to convey post-construction stormwater runoff on development sites shall meet the following requirements:

- (1) Methods used to calculate stormwater runoff rates and volumes shall be in accordance with the information presented in the latest edition of the *Georgia Stormwater Management Manual* and any relevant local addenda;
- (2) All culverts, pipe systems and open channel flow systems shall be sized in accordance with the information presented in the latest edition of the *Georgia Stormwater Management Manual* and any relevant local addenda; and,
- (3) Planning and design of stormwater conveyance practices shall be completed in accordance with the information presented in the latest edition of the *Georgia Stormwater Management Manual* and any relevant local addenda.

5.0 Construction Inspection of Stormwater Management Systems

Construction Inspection of Stormwater Management Systems

- The Construction Inspection section of a post-construction stormwater management ordinance outlines the regulatory requirements for inspecting and reporting on permanent green infrastructure and stormwater management practices during construction.
- The ordinance should be clear about who is responsible for conducting inspections (the responsible party, a local government department, or some combination of the two), and the type and frequency of reporting that must be submitted.

5.1 Notice of Construction Commencement

The applicant must notify the (*local jurisdiction*) prior to the commencement of construction on a development site. In addition, the applicant must notify the (*local jurisdiction*) in advance of the installation of critical components of the stormwater management system shown on the approved stormwater management design plan. The (*local jurisdiction*) may, at its discretion, issue verbal or written authorization to proceed with the installation of critical components of the stormwater management system, such as permanent green infrastructure and stormwater management practices, based on the stabilization of contributing drainage areas and other factors.

5.2 Inspections During Construction

Periodic inspections of the green infrastructure and stormwater management practices shown on the approved stormwater management design plan shall be conducted by staff or representatives of the (*local jurisdiction*) during construction. Construction inspections shall utilize the approved stormwater management design plan for establishing compliance with the provisions of this ordinance. All inspections shall be documented in written reports that contain the following information:

- (1) The date and location of the inspection;
- (2) The name of the inspector;
- (3) Whether construction is in compliance with the approved stormwater management design plan;
- (4) Violations of the approved stormwater management design plan; and,
- (5) Any other variations from the approved stormwater management plan.

If any violations are found, the applicant shall be notified in writing about the nature of the violation and the remedial measures that are required to bring the action or inaction into compliance with the approved stormwater management design plan, as described in Section 7.1 of this ordinance. In the event that the remedial measures described in such notice have not been completed by the date set forth in the notice, any one or more of the enforcement actions outlined in Section 7.2 of this ordinance may be taken against the applicant.

5.3 Final Inspection and As Built Plans

Subsequent to the final installation and stabilization of all green infrastructure and stormwater management practices shown on the approved stormwater management design plan, and before the issuance of a certificate of occupancy, the applicant is responsible for certifying that the project has been completed in accordance with the approved stormwater management design plan and submitting as built plans for all green infrastructure and stormwater management practices shown on the approved stormwater management design plan. The as built plans must show the final design specifications for all green infrastructure and stormwater management practices and must be certified by a licensed design professional such as a landscape architect, professional surveyor or professional engineer. A final inspection shall be conducted by the staff or representatives of the (local jurisdiction) to confirm the accuracy of the as built plans. A final inspection is required before any performance bond or other guarantee can be released.

6.0 Ongoing Inspection and Maintenance of Stormwater Management Systems

6.1 Maintenance Responsibility

The responsible party named in the recorded stormwater management system inspection and maintenance agreement and plan (Section 3.4), shall maintain in good condition and promptly repair and restore all green infrastructure and stormwater management practices, maintenance access routes and appurtenances, including, but not limited to surfaces, walls, drains, dams, structures, vegetation, erosion and sediment control practices and other protective devices. Such repairs and restoration and maintenance activities shall be performed in accordance with an approved inspection and maintenance agreement and plan.

If the responsible party named in the recorded inspection and maintenance agreement and plan is a homeowner's association or other owner's association, such as a unit owner's association, the responsible party shall submit to the (*local jurisdiction*) a copy of a recorded declaration that provides:

- (1) That green infrastructure and stormwater management practices are part of the common elements of the development site and shall be subject to the requirements of the stormwater management system inspection and maintenance agreement and plan;
- (2) That membership in the association shall be mandatory and automatic for all homeowners or unit owners of the development site and their successors;
- (3) That the association shall have lien authority to ensure the collection of dues from all members;
- (4) That the requirements of the inspection and maintenance agreement and plan shall receive the highest priority for expenditures by the association except for any other expenditures that are required by law to have a higher priority;
- (5) That a separate fund shall be maintained by the association for the routine maintenance, reconstruction and repair of the green infrastructure and stormwater management practices, and kept in an account insured by the Federal Deposit Insurance Corporation (FDIC) or by another entity acceptable to the (*local jurisdiction*);

- (6) That the routine maintenance, reconstruction and repair fund shall contain at all times the dollar amount reasonably determined from time to time by the *(local jurisdiction)* to be adequate to pay for the probable reconstruction and repair cost (but not routine maintenance cost) of the stormwater management system for a three-year period; and,
- (7) That, to the extent permitted by law, the association shall not enter into voluntary dissolution unless responsibility for the green infrastructure and stormwater management practices is transferred to an appropriate successor.

The *(local jurisdiction)*, in lieu of an inspection and maintenance agreement and plan, may accept the dedication of any existing or future green infrastructure or stormwater management practice for maintenance, provided that such practice meets all of the requirements of this ordinance, is in proper working order at the time of dedication and includes adequate and perpetual access and sufficient area for inspection and regular maintenance. Such adequate and perpetual access shall be accomplished by granting of an easement to the *(local jurisdiction)* or through a fee simple dedication to the *(local jurisdiction)*.

6.2 Maintenance Inspections

Periodic inspections of the green infrastructure and stormwater management practices shown on an approved stormwater management design plan, and subject to the terms and conditions of an approved inspection and maintenance agreement and plan, shall be conducted by staff or representatives of the *(local jurisdiction)* to document repair and maintenance needs and ensure compliance with the requirements of the approved inspection and maintenance agreement and plan and provisions of this ordinance. All inspections should be documented in written reports that contain the following information:

- (1) The date and location of the inspection;
- (2) The name of the inspector;
- (3) The condition of:
 - (a) Vegetation and filter media;
 - (b) Fences and other safety devices;
 - (c) Spillways, valves and other hydraulic control structures;
 - (d) Embankments, slopes and safety benches;
 - (e) Reservoirs and permanent pools;
 - (f) Inlet and outlet channels and structures;
 - (g) Underground drainage structures;
 - (h) Sediment and debris accumulation in storage and forebay areas;
 - (i) Any other item that could affect the proper function of the stormwater management system; and,

- (4) A description of repair, restoration and maintenance needs.

If any repair, restoration or maintenance needs are found, the responsible party named in the recorded stormwater management system inspection and maintenance agreement and plan shall be notified in writing about the repair, restoration or maintenance needs and the remedial measures that are required to bring the stormwater management system into compliance with the approved stormwater management system inspection and maintenance agreement and plan, as described in Section 7.1 of this ordinance. In the event that the remedial measures described in such notice have not been completed by the date set forth in the notice, any one or more of the enforcement actions outlined in Section 7.2 of this ordinance may be taken against the responsible party named in the approved stormwater management system inspection and maintenance agreement and plan.

6.3 Records of Maintenance Activities

The responsible party shall make and maintain records of all inspections, maintenance and repairs, and shall retain the records for a minimum of five years. These records shall be made available to the (*local jurisdiction*) during inspections and at other reasonable times upon request of the (*local jurisdiction*).

6.4 Failure to Maintain

If the responsible party fails or refuses to meet the terms and conditions of an approved stormwater management system inspection and maintenance agreement and plan and/or the requirements of this ordinance, the (*local jurisdiction*), after thirty (30) days written notice (except, that in the event the violation constitutes an immediate danger to public health or safety, 24 hours notice shall be sufficient), may correct a violation by performing the work necessary to place the green infrastructure or stormwater management practice in proper working condition. The (*local jurisdiction*) may assess the responsible party for the cost of the repair work, which shall be a lien on the property, and may be placed on the ad valorem tax bill for such property and collected in the ordinary manner for such taxes by the (*local jurisdiction*).

7.0 Violations, Enforcement and Penalties

Any action or inaction that violates the provisions of this ordinance or the requirements of an approved stormwater management design plan, permit or inspection and maintenance agreement and plan, may be subject to the enforcement actions outlined in this section. Any such action or inaction that is continuous with respect to time may be deemed to be a public nuisance and may be abated by injunctive or other equitable relief. The imposition of any of the penalties described below shall not prevent such equitable relief.

7.1 Notice of Violation

If the (*local jurisdiction*) determines that an owner, applicant or other responsible person has failed to comply with the provisions of this ordinance, or the terms and conditions of an approved stormwater management design plan, permit or inspection and maintenance agreement and plan, it shall issue a written notice of violation to said owner, applicant or other responsible person. Where a person is engaged in a new development or redevelopment activity covered by this ordinance without having first secured a stormwater management permit, the notice of violation shall be served on the owner or the person in charge of the new development or redevelopment activity being conducted on the development site.

The notice of violation shall contain the following information:

- (1) The name and address of the owner, applicant or other responsible person;
- (2) The address or other description of the site upon which the violation is occurring;
- (3) A statement specifying the nature of the violation;
- (4) A description of the remedial measures necessary to bring the action or inaction into compliance with the provisions of this ordinance, or the terms and conditions of the approved stormwater management design plan, permit or inspection and maintenance agreement and plan, and the date for the completion of such remedial measures;
- (5) A statement of the penalty or penalties that may be assessed against the person to whom the notice of violation is issued; and,
- (6) A statement that the determination of violation may be appealed to the (*local jurisdiction*) by filing a written notice of appeal within thirty (30) days after the notice of violation (except, that in the event the violation constitutes an immediate danger to public health or safety, a written notice of appeal must be filed within 24 hours after the notice of violation).

7.2 Penalties

Penalties

- Many local post-construction stormwater management ordinances do not have a schedule of civil penalties as laid out below. The advantage of having such a schedule is that it makes the civil penalties easier for the local jurisdiction to apply and administer. The violations that are tied to each penalty and the penalty amounts themselves can be modified.
- It is important to check with legal staff before including a schedule of civil penalties within a local post-construction stormwater management ordinance. Other state or local codes may specify how civil penalties can be applied.

In the event that the remedial measures described in the notice of violation have not been completed by the date set forth for completion in the notice of violation, any one or more of the following actions or penalties may be taken or assessed against the person to whom the notice of violation was issued.

Before taking any of the following actions or imposing any of the following penalties, the (*local jurisdiction*) shall first notify the owner, applicant or other responsible person in writing of its intended action and shall provide a reasonable opportunity of not less than ten days (except, that in the event the violation constitutes an immediate danger to public health or safety, 24 hours notice shall be sufficient) to correct the violation. In the event the owner, applicant or other responsible person fails to correct the violation by the date set forth in said notice, the (*local jurisdiction*) may take any one or more of the following actions or impose any one or more of the following penalties.

- (1) **Stop Work Order:** The (*local jurisdiction*) may issue a stop work order that shall be served on the owner, applicant or other responsible person. The stop work order shall remain in effect until the owner, applicant or other responsible person has taken the remedial

- measures set forth in the notice of violation or has otherwise corrected the violation or violations described therein. The stop work order may temporarily be withdrawn or modified by the *(local jurisdiction)* to enable the applicant or other responsible person to take the remedial measures necessary to correct such violation or violations.
- (2) **Withhold Certificate of Occupancy:** The *(local jurisdiction)* may refuse to issue a certificate of occupancy for the building or other structure constructed or being constructed on the development site until the owner, applicant or other responsible person has taken the remedial measures set forth in the notice of violation or has otherwise corrected the violation or violations described therein.
 - (3) **Suspension, Revocation, or Modification of Permit:** The *(local jurisdiction)* may suspend, revoke or modify the permit authorizing the development project. A suspended, revoked or modified permit may be reinstated after the owner, applicant or other responsible person has taken the remedial measures set forth in the notice of violation or has otherwise corrected the violation or violations described therein. The permit may be modified by the *(local jurisdiction)* to enable the owner, applicant or other responsible person to take the remedial measures necessary to correct such violation or violations.
 - (4) **Civil Penalties:** In the event the owner, applicant or other responsible person fails to take the remedial measures set forth in the notice of violation or otherwise fails to correct the violation or violations described therein, by the date set forth in the notice of violation, the *(local jurisdiction)* may impose a penalty not to exceed \$1,000 (depending on the severity of the violation) for each day the violation remains unremedied after the date set forth in the notice of violation.
 - (5) **Criminal Penalties:** For intentional and flagrant violations of this ordinance, the *(local jurisdiction)* may issue a citation to the owner, applicant or other responsible person, requiring said person to appear in *(appropriate municipal court)* court to answer to criminal charges for such violation. Upon conviction, such person shall be punished by a fine not to exceed \$1,000, imprisonment for up to 60 days or both. Each act of violation and each day upon which any violation shall occur shall constitute a separate offense.

THIS PAGE INTENTIONALLY LEFT BLANK