

FIELD MANUAL FOR EROSION & SEDIMENT CONTROL IN GEORGIA

*Vegetative & Structural BMPs for
Land-Disturbing Activities*



2016 Edition

FIELD MANUAL FOR EROSION & SEDIMENT CONTROL IN GEORGIA

2016 Edition



Georgia Soil & Water Conservation Commission
4310 Lexington Road
P.O. Box 8024
Athens, GA 30603
706-552-4470
www.gaswcc.org

Technical Editors: Brady Hart, Benton Ruzowicz, Susan Castle, & Guerry Thomas

All programs and services of the federal, state, and local agencies listed above are available on a nondiscriminatory basis without regard to race, color, national origin, religion, sex, age, marital status, handicap or disability. If you need this document in an alternative format, please call (706) 552-4470.

TABLE OF CONTENTS

| | PAGE |
|--------------|------|
| INTRODUCTION | 6 |

VEGETATIVE BEST MANAGEMENT PRACTICES

| | | |
|--------------|---|----|
| Bf | Buffer Zone | 10 |
| Cs | Coastal Dune Stabilization | 14 |
| Ds1 | Disturbed Area Stabilization (With Mulching Only) | 18 |
| Ds2 | Disturbed Area Stabilization (With Temporary Seeding) | 20 |
| Ds3 | Disturbed Area Stabilization (With Permanent Vegetation) | 26 |
| Ds4 | Disturbed Area Stabilization (With Sodding) | 38 |
| Du | Dust Control on Disturbed Area | 42 |
| FI-Co | Flocculants and Coagulants | 46 |
| Sb | Streambank Stabilization (With Permanent Vegetation) | 48 |
| Ss | Slope Stabilization | 56 |
| Tac | Tackifiers | 59 |

STRUCTURAL BEST MANAGEMENT PRACTICES

| | | |
|-----------|---------------------------------|----|
| Cd | Check Dam | 65 |
| Ch | Channel Stabilization | 69 |
| Co | Construction Exit | 73 |
| Cr | Construction Road Stabilization | 75 |
| Dc | Stream Diversion Channel | 77 |
| Di | Diversion | 81 |

| | | |
|------------|--|-----|
| Dn1 | Temporary Downdrain Structure | 83 |
| Dn2 | Permanent Downdrain Structure | 87 |
| Fr | Filter Ring | 89 |
| Ga | Gabion | 91 |
| Gr | Grade Stabilization Structure | 93 |
| Lv | Level Spreader | 95 |
| Rd | Rock Filter Dam | 97 |
| Re | Retaining Wall | 99 |
| Rt | Retrofit | 101 |
| Sd1 | Sediment Barrier | 105 |
| Sd2 | Inlet Sediment Trap | 111 |
| Sd3 | Temporary Sediment Basin | 119 |
| Sd4 | Temporary Sediment Trap | 125 |
| Sk | Floating Surface Skimmer | 129 |
| SpB | Seep Berm | 131 |
| Sr | Temporary Stream Crossing | 135 |
| St | Storm Drain Outlet Protection | 139 |
| Su | Surface Roughening | 143 |
| Tc | Turbidity Curtain | 147 |
| Tp | Topsoiling | 151 |
| Tr | Tree Protection | 153 |
| Wt | Vegetated Waterway or Stormwater Conveyance Channel | 155 |

| | |
|--|-----|
| THE EROSION & SEDIMENT CONTROL ACT OF 1975, AS AMENDED | 159 |
| THE NATIONAL POLLUTION DISCHARGE ELIMINATION SYSTEM (NPDES) PERMIT | 166 |
| APPENDIX A-2: JOINING THE EQUIVALENT BMP LIST | 167 |
| CONSTRUCTION CHECKLIST | 169 |
| GLOSSARY | 187 |
| POINTS OF CONTACT | 198 |
| COMMONLY USED ACRONYMS | 207 |

INTRODUCTION

The First Edition of this Field Manual was printed in 1979 and revised in 1988, 1997, 2002, and 2016. Georgia's Erosion and Sedimentation Law has been amended several times since 1975 with major changes throughout the years. The emphasis shifted from water quality to meeting "minimum requirements." This means that Best Management Practices (BMPs) must be properly designed, installed, and maintained in accordance with sound conservation and engineering principals.

This Field Manual has been prepared primarily to assist field personnel involved in on-site land-disturbing activities. It should be helpful as a quick reference in the actual installation and maintenance of BMPs. The inclusion of detailed design information has purposely been kept to a minimum. For more detailed information, please consult the [Manual for Erosion & Sediment Control in Georgia](#).

BMPs are vegetative measures and structural practices that control the erosion of soil and the resulting sedimentation. The law mandates that all BMPs stand up to a 25-year rainfall event or the land disturber is subject to severe civil penalties.

The key to well-planned land-disturbing activities is well-informed persons in the field; the individual for whom this Field Manual is written. Common sense and a working knowledge of the tools that nature has provided will lead to good site development.

The Georgia Law is called the “Erosion and Sedimentation Act” (O.C.G.A. 12-7-1). Erosion and sedimentation are 2 separate processes. If erosion is controlled, sediment is not detached and transported. Therefore, to have good erosion and sediment control, emphasis has to be placed on controlling erosion at the source. Sediment control should be considered the last line of defense. Allowing any erosion to occur is the first step toward non-compliance.

Complete erosion control does not usually involve engineered structures, just sensible planning and the immediate application of ground covers that includes mulch and vegetation. Nature has provided us with an abundance of trees, shrubs, and grasses, all of which are effective erosion control tools if used in a timely manner.

If your ES&PC plan does not show a vegetative buffer around a site but there is an area on the perimeter that does not require cleaning, then save the existing vegetation. A good vegetative buffer 25-35 ft wide can trap 85-95% of the sediment in runoff water.

If a site is properly engineered, cut and fill slopes can be mulched or vegetated daily. Mulch does not require water, fertilizer, or lime. A good application of mulch can reduce soil loss by up to 98%.

Use conventional planting methods, when feasible. Sodding may initially be more expensive...but how much more? If a site has to be planted several times, then it may be cheaper to sod rather than seed bare slopes. Even if the sod does die, most sodded areas will protect bare areas from erosion during the duration of the land-disturbing activity.

To summarize, save as much existing vegetation as possible and mulch/vegetate as early and frequently as possible.

The BMPs listed in this manual are intended to provide minimum control for erosion and sedimentation problems as required by State Law. However, other measures and innovative practices that are at least as effective as the listed practices are encouraged. While the emphasis is on meeting the requirements of the State Law, land disturbers must also comply with all other local, state, and federal laws including the Section 404 Permit issued by the Army Corps of Engineers (USACE) and the NPDES Permits administered by the Georgia Environmental Protection Division (GA EPD). Local Issuing Authorities (LIA) must ensure compliance on these regulations before issuing a land disturbing activity permit (LDA).

The Commission is grateful to the staff who assisted in the preparation of this publication. We welcome any notice of error or omissions we may correct in our next publication.

Throughout the Manual, many provisions of the E&S Act and subsequent rules and regulations have been paraphrased or shortened for convenience. Any interpretations or opinions expressed in this shortened format are those of the Commission and are provided for quick reference only. In matters of litigation, the Law and Courts have the final decision.

VEGETATIVE BEST MANAGEMENT PRACTICES

- Bf** Buffer Zone
- Cs** Coastal Dune Stabilization
- Ds1** Disturbed Area Stabilization
(With Mulching Only)
- Ds2** Disturbed Area Stabilization
(With Temporary Seeding)
- Ds3** Disturbed Area Stabilization
(With Permanent Vegetation)
- Ds4** Disturbed Area Stabilization
(With Sodding)
- Du** Dust Control on Disturbed Area
- Fl-Co** Flocculants and Coagulants
- Sb** Streambank Stabilization
(With Permanent Vegetation)
- Ss** Slope Stabilization
- Tac** Tackifiers

The products and practices presented in this Field Manual show the standard installation methods for each conventional BMP. New products and practices may not necessarily meet the requirements for each conventional BMP. Please see the Equivalent Best Management Practice List for specific manufacturer guidelines and specifications.

DEFINITION

A strip of undisturbed, original vegetation, enhanced or restored existing vegetation or the re-establishment of vegetation surrounding an area of disturbance or bordering streams, ponds, wetlands, lakes, and coastal waters

**PURPOSE**

- Reduce storm runoff velocities
- Act as screen for “visual pollution”
- Reduce construction noise
- Improve aesthetics
- Filtering and infiltrating runoff
- Cooling rivers and streams by creating shade
- Provide food and cover for wildlife and aquatic organisms
- Flood protection
- Protect channel banks from erosion

INSTALLATION

- Important factors, such as slope, hydrology, width, and structure shall be considered.
- The GA EPD enforces a 25 ft minimum undisturbed stream buffer requirement for warm water fisheries and a 50 ft minimum undisturbed stream buffer requirement for cold water fisheries.

- If any land-disturbing activity, exempt or non-exempt, occurs within a mandated stream buffer, all cut and fills shall be stabilized with appropriate slope stabilization.

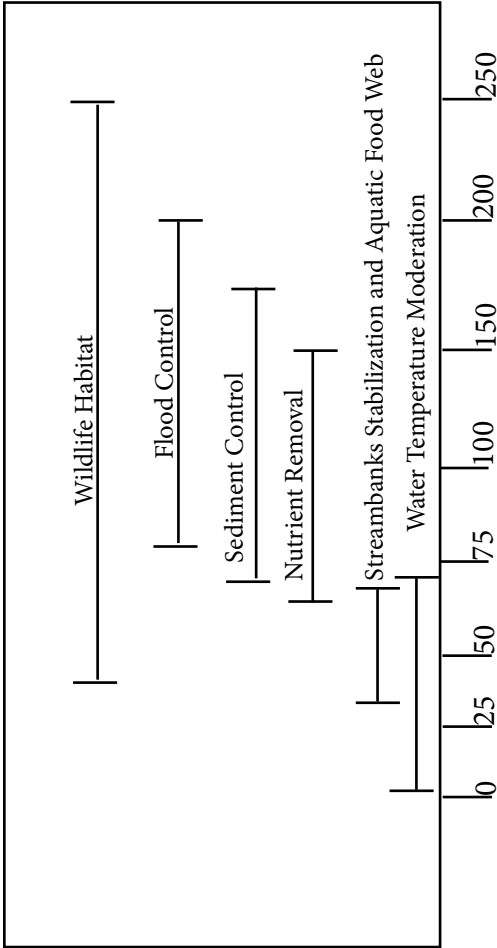

Types of Buffers

Figure 1. Range of Minimum Width (ft.) for Meeting Specific Buffer Objectives (Palone & Todd, draft)

General Buffer

- A strip of undisturbed, original land surrounding the disturbed site.
- A width should be selected to permit the zone to serve the purpose(s) listed above.

Vegetated Stream Buffer

- A vegetated stream buffer of 50 ft or greater can protect waters from excess sedimentation.

Bf

- The size of the stream and topography of the area must be considered to determine the appropriate width.
- The buffer should be increased 2 ft in width for every 1% slope.

Planting Techniques

- Plantings for buffer re-establishment and enhancement can consist of bare root seedlings, container-grown seedlings, container-grown plants, and balled and burlapped plants.
- Standard erosion control grasses and legumes may be used in denuded areas for quick stabilization.
- Refer to Tables 6-1.1 & 6-1.2 in the Manual for Erosion & Sediment Control in Georgia for complete listing of all Native Plants & Unrooted Hardwood Cuttings.
- Streambank stabilization techniques may be required if steep slopes and hydrologic patterns deem it necessary.
- Soil preparation and maintenance are essential for the establishment of planted vegetation.

Table 1. Effectiveness of Vegetative Buffer Strips

| Purpose | Grass | Shrub | Tree |
|------------------------|--------------|--------------|-------------|
| Filter Sediment | High | Low | Low |
| Filter Chemicals | Medium | Low | Low |
| Stabilize Stream Banks | Low | High | High |
| Improve Aesthetics | Low | Medium | High |
| Improve Habitat | Low | Medium | High |
| Reduce Noise | Low | Medium | High |

MAINTENANCE

- Areas closest to the stream should be maintained with minimal impact.
- During periods of drought, water as necessary in all buffer areas planted for enhancement.
- Remove weeds by hand or with careful spraying.
- Monitor to determine if plant material needs to be replaced.
- Fertilizer is unnecessary if the appropriate vegetation is chosen.

REFERENCES

- | | |
|------------|---|
| Ds1 | Disturbed Area Stabilization (With Mulching Only) |
| Ds2 | Disturbed Area Stabilization (With Temporary Seeding) |
| Ds3 | Disturbed Area Stabilization (With Permanent Vegetation) |
| Sb | Streambank Stabilization (With Permanent Vegetation) |

COASTAL DUNE STABILIZATION (WITH VEGETATION)

DEFINITION

Planting vegetation on dunes that are denuded, artificially constructed, or renourished.



PURPOSE

- Stabilize soil on dunes allowing them to become more resistant to wind and waves.
- Allow development of dunes in areas where they have been damaged or destroyed.

INSTALLATION

- Install in accordance with the approved plan.
- Install in accordance with all Federal, State and local regulations.
- Protect dunes from vehicular and human traffic.
- Provide crosswalks or crossover structures to allow for beach access.
- Irrigate during the first growing season in order to obtain good survival.
- Native plants commercially available that may be planted are included in Table 1.

Table 1. Planting Requirements for Native Plants

| Species | Stock | Date | Depth |
|--|--------------------|--------|-------|
| Marshay Cordgrass (<i>Spartina patens</i>) | Plants | Spring | 4"-5" |
| Bitter Panicum (<i>Panicum amarum</i>) | Rhizomes | Spring | ~4" |
| Coastal Panigrass (<i>Panicum amarum</i> v. <i>amaralum</i>) | Seeds or Plants | Spring | 1"-3" |



Figure 1. Sand Fence and Native Plants

Sand Fence

- Install according to approved plan.
- Use posts made of Black Locust, Red or White Cedar, or similarly durable wood.
- Use posts with minimum length of 7 ft and minimum diameter of 3".
- Space posts at a maximum of 10 ft.
- Entrench posts a minimum of 3 ft.
- Fasten fence to posts with four 12-gauge galvanized wires.
- Vegetation must be established immediately following development of the dunes.
- Use standard commercial 4-ft high snow fence that consists of wooden slats wired together with 1-1/4" spaces between the slats (See Figure 2)

Barrier Dune Construction

- Install sand fence a minimum of 100 ft from the mean high tide line.
- Space 2 or more parallel fences 30-40 ft apart.
- Locate fences as close to perpendicular with the prevailing winds, but as near parallel to the water line as possible
- When the winds are generally parallel to the water line, construct a single line of fence at least 140 ft from the mean high tide line with a shorter 30 ft section perpendicular to the original fence.
- Place these fences opposite the water side and space these fences about 40 ft apart.

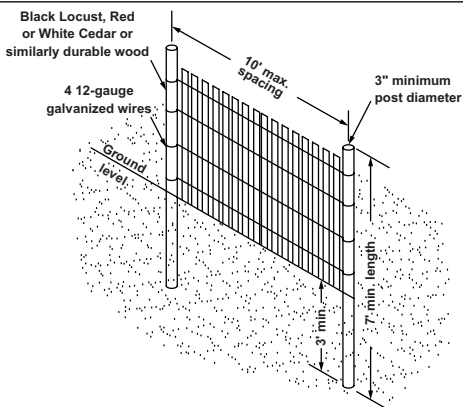
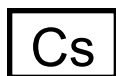

Figure 2. Sand Fence Installation Requirements

MAINTENANCE

- Repair any blowouts, wash pits, or other natural or man-made damage quickly.
- Maintain fences and erect additional fences if needed until the eroding area is replenished.
- Replant lost or destroyed vegetation.
- Apply 50 lbs of nitrogen/acre/year.
- Protect dunes from traffic by using elevated walks, semi-permanent paved paths, and portable roll-up walkways .



(This page left blank intentionally.)

Ds1

DISTURBED AREA STABILIZATION (WITH MULCHING ONLY)

DEFINITION

A temporary cover of plant residues or other suitable materials, produced on site if possible, applied to the soil surface.



PURPOSE

- Reduce runoff and erosion
- Modify soil temperature
- Conserve moisture
- Prevent surface compaction and crusting
- Control undesirable vegetation
- Increase biological activity in the soil

INSTALLATION

- Apply mulch or temporary grassing to all exposed areas within 14 days of disturbance.
- Applicable to graded or cleared areas where seedings may not have a suitable growing season to produce an erosion retardant cover.
- Mulch can be used as a singular erosion control device for up to 6 months.
- Apply at the appropriate depth. Refer to Table 1 for specific materials.

Site Preparation

- Grade to permit the use of equipment for applying and anchoring mulch

- Install needed erosion control measures such as dikes, berms, and sediment barriers.
- Loosen compacted soil to a minimum depth of 3”.

Applying Mulch

- Apply dry straw or hay and wood chips uniformly by hand or by mechanical equipment.
- Apply 20-30 lbs of nitrogen/acre if the area will eventually be covered with perennial vegetation.
- Apply polyethylene film on exposed areas.

Anchoring Mulch

- Press straw or hay into the soil with a disk harrow immediately after application. Tackifiers may be used when spreading mulch with blower-type equipment.
- Anchor wood waste using the appropriate size netting
- Trench polyethylene at the top as well as incrementally as necessary.

Table 1. Mulching Application Requirements

| Material | Rate | Depth |
|--|------------------------------------|--------------|
| Straw or hay | - | 2” to 4” |
| Wood waste, chips, sawdust, bark | - | 2” to 3” |
| Polyethylene film | Secure with soil, anchors, weights | - |
| Geotextiles, jute matting, netting, etc. | See manufacturer’s recommendations | - |

MAINTENANCE

- The appropriate depth and 90% cover shall be maintained at all times.

REFERENCES

Tac Tackifiers

DISTURBED AREA STABILIZATION

(WITH TEMPORARY SEEDING)

DEFINITION

The establishment of temporary vegetative cover with fast growing seedings for seasonal protection on disturbed or denuded areas.



PURPOSE

- Reduce runoff and sediment damage of downstream resources
- Protect the soil surface from erosion
- Improve wildlife habitat
- Improve aesthetics
- Improve tilth, infiltration, and aeration as well as organic matter for permanent plantings

INSTALLATION

- Apply mulch or temporary grassing to all exposed areas within 14 days of disturbance.
- Applicable to rough graded areas that will be exposed for less than 6 months.
- Coordinate with permanent measures to ensure economical and effective stabilization.
- Take note of which species are not appropriate for companion crop plantings.
- When the soil has been sealed by rainfall or consists of smooth cut slopes, scarify the soil in order to provide a place for the seed to lodge and germinate.

- Apply agricultural lime at the rate determined by soil test pH.
- Apply lime before land preparation and incorporate with a disk, ripper, or chisel.
- On steep slopes, apply fertilizer hydraulically.
- Select grass or grass-legume mixtures based on the area and season of the year.
- Apply seed uniformly by hand, cyclone seeder, drill, culti-packer-seeder, or hydraulic seeder.
- The appropriate depth of planting is 10x the seed diameter.
- Apply irrigation at a rate that will not cause runoff and erosion. Thoroughly wet the soil to insure germination of the seed.

MAINTENANCE

- Re-seed areas where an adequate stand of temporary vegetation fails to emerge.
- If optimum conditions for temporary vegetation is lacking, mulch can be used a singular erosion control device.

REFERENCES

Ds1Disturbed Area Stabilization
(With Mulching Only)**Tac**

Tackifiers



Figure 2. Browntop Millet



Figure 3. Ryegrass

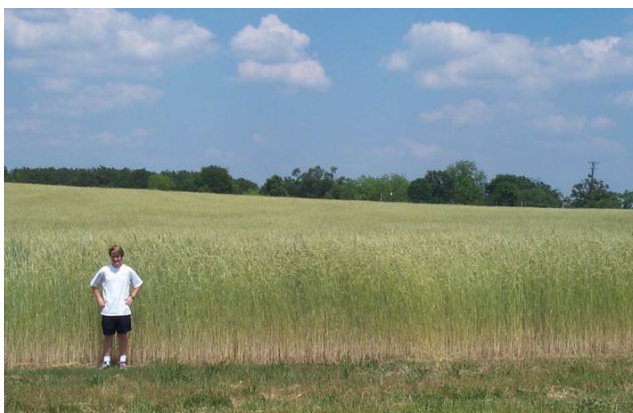

Figure 3. Rye

Table 1. Some Temporary Plant Species, Seeding Rates and Planting Dates

| Species | Rates Per 1,000 sq. ft. | Rates per Acre | Planting Dates by Region | | |
|---|----------------------------|--------------------|--------------------------|------------|------------|
| | | | M-L | P | C |
| Barley Alone Barley in Mixtures | 3.3 lbs. .6 lbs. | 3 bu. .5 bu. | 9/1-10/31 | 9/15-11/15 | 10/1-12/31 |
| Lespedeza, Annual Lespedeza in Mixtures | 0.9 lbs. 0.2 lbs. | 40 lbs. 10 lbs. | 3/1-3/31 | 3/1-3/31 | 2/1-2/28 |
| Lovegrass, Weeping Lovegrass in Mixtures | 0.1 lbs. .05 lbs. | 4lbs. 2 lbs. | 4/1-5/31 | 4/1-5/31 | 3/1-5/31 |
| Millet, Browntop Millet in Mixtures | .9 lbs. .2 lbs. | 40 lbs. 10 lbs. | 4/15-6/15 | 4/15-6/30 | 4/15- 6/30 |
| Millet, Pearl | 1.1 lbs. | 50 lbs. | 5/15-7/15 | 5/1-7/31 | 4/15-8/15 |
| Oats Alone Oats in Mixtures | 2.99 lbs. .7 lbs. | 4 bu. 1 bu. | 9/15 -11/15 | 9/15-11/15 | 9/15-11/15 |

23

DS2

Table 1. Some Temporary Plant Species, Seeding Rates and Planting Dates (continued)

| Species | Rates Per 1,000 sq. ft. | Rates per Acre | Planting Dates by Region | | |
|--|----------------------------|-------------------|--------------------------|-------------|-------------|
| | | | M-L | P | C |
| Rye (Grain) Alone Rye in Mixtures | 3.9 lbs. .6 lbs. | 3 bu. .5 bu. | 8/15-10/31 | 9/15/-11/30 | 10/1-12/31 |
| Ryegrass | 0.9 lbs. | 40 lbs. | 8/15-11/15 | 9/1-12/15 | 9/15-12/31 |
| Sudangrass | 1.4 lbs. | 60 lbs. | 5/1-7/31 | 5/1-7/31 | 4/1-7/31 |
| Triticale Alone Triticale in Mixtures | 3.3 lbs. .6 lbs | 3 bu. .5 bu. | NA | NA | 10/15-11/30 |
| Wheat Alone Wheat in Mixtures | 4.1 lbs. .7 lbs. | 3 bu. .5 bu. | 9/15 -11/30 | 10/1-12/15 | 10/15-12/31 |

1. Unusual site conditions may require heavier seeding rates.
2. Seeding dates may need to be altered to fit temperature variations and local conditions.
3. For Major Land Resource Areas (MLRAs), see page 60.
4. Seeding rates are based on pure live seed (PLS).

Table 2. Fertilizer Requirements for Temporary Vegetation

| Types of Species | Planting Year | Fertilizer (N-P-K) | Rate (lbs./acre) | N Top Dressing Rate (lbs./acre) |
|------------------------------------|---------------|--------------------|------------------|---------------------------------|
| Cool season grasses | First | 6-12-12 | 1500 | 50-100 |
| | Second | 6-12-12 | 1000 | --- |
| | Maintenance | 10-10-10 | 400 | 30 |
| Cool season grasses & legumes | First | 6-12-12 | 1500 | 0-50 |
| | Second | 0-10-10 | 1000 | --- |
| | Maintenance | 0-10-10 | 400 | --- |
| Temporary cover crops seeded alone | First | 10-10-10 | 500 | 30 |
| Warm season grasses | First | 6-12-12 | 1500 | 50-100 |
| | Second | 6-12-12 | 800 | 50-100 |
| | Maintenance | 10-10-10 | 400 | 30 |

Ds3

DISTURBED AREA STABILIZATION

(WITH PERMANENT SEEDING)

DEFINITION

The planting of perennial vegetation such as trees, shrubs, vines, grasses, or legumes on exposed areas for final permanent stabilization.



PURPOSE

- Protect the soil surface from erosion
- Reduce damage from sediment and runoff to down-stream areas
- Improve wildlife habitat and visual resources
- Improve aesthetics

INSTALLATION

- Use conventional planting methods where possible.
- Final Stabilization means that 100% of the soil surface is uniformly covered in permanent vegetation with a density of 70% or greater, or landscaped according to the plan (uniformly covered landscaping materials in planned landscaped areas), or equivalent permanent stabilization measures.
- Select plants species based on site and soil conditions, planned use and maintenance of the area, time of year, method of planting, and the needs of the land user. (Refer to Table 1)

- Apply agricultural lime at a rate of 1-2 tons/acre unless soil tests indicate otherwise. Please refer to Table 2 for initial fertilization, nitrogen, topdressing, and maintenance fertilizer requirements for each species.
- Apply seed hydraulically. If using conventional methods, use a culti-packer seeder, drill, rotary seeder, or by hand.
- Cover the seed lightly with 1/8"-1/4" of soil for small seed and 1/2"-1" of soil for large seed when using a cultipacker.
- Check seed tags for % germination & % purity in order to calculate Pure Live Seed (PLS), which is the percentage of the seeds that are pure and will germinate.
- Mulch is required for all permanent vegetation applications. Please refer to **Ds1** for application rates and anchoring methods for different materials.
- Irrigate when the soil is dry and at a rate that will not cause runoff.

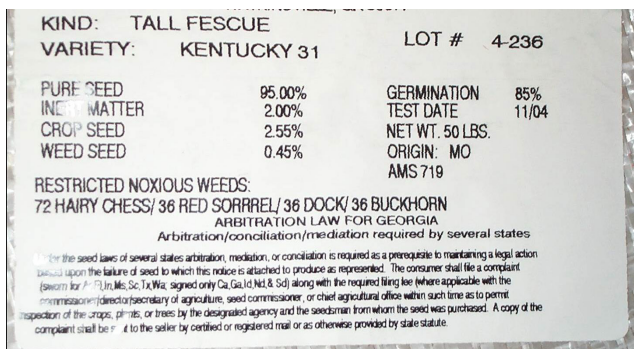

Figure 1. Typical Tag on a Bag of Seed

PLS Example

Tall Fescue

85% germination & 95% purity

PLS = 0.85 germination x 0.95 purity

PLS = 80.75%

Seeding rate = 50 lbs. PLS/acre = 61.92 lbs/acre

PLS 80.75% PLS

Table 1. Some Permanent Plant Species, Seeding Rates, and Planting Dates

| Species | Rates per Acre | Rates per 1,000 sq. ft | Planting Dates by Region | | | Remarks |
|---|--------------------|------------------------|--------------------------|-----------|-----------|---|
| | | | M- L | P | C | |
| Bahia, Pensacola Alone or with temporary cover With other perennials | 60 lbs. 30 lbs. | 1.4 lbs. 0.7 lb. | --- | 4/1 -5/31 | 3/1-5/31 | Low growing; sod producing; will spread into Bermuda lawns. |
| Bahia, Wilmington Alone or with temporary cover With other perennials | 60 lbs. 30 lbs. | 1.4 lbs. 0.7 lb. | 3/15-5/31 | 3/1-5/31 | — | Same as above |
| Bermuda, Common (Hulled seed) Alone With other perennials | 10 lbs. 6 lbs. | 0.2 lb. 0.1 lb. | --- | 4/1-5/31 | 3/15-5/31 | Quick cover; low growing; sod forming; needs full sun. |
| Bermuda, Common (Unhulled seed) With temporary cover With other perennials | 10 lbs. 6 lbs. | 0.2 lb. 0.1 lb | --- | 10/1-2/28 | 11/1-1/31 | Plant with Winter annuals. Plant with Tall Fescue |

Table 1. Some Permanent Plant Species, Seeding Rates, and Planting Dates (continued)

| Species | Rates per Acre | Rates per 1,000 sq. ft | Planting Dates by Region | | | Remarks |
|--|--------------------|------------------------|------------------------------|-----------|-----------|--|
| | | | M- L | P | C | |
| Bermuda Springs Common lawn and forage hybrids | 40 cu. ft. | 0.9 cu.ft. | 4/15-6/15 | 4/1-6/15 | 4/1-5/31 | 1 cu. ft. = 650 sprigs 1 bu. = 1.25 cu. ft. or 800 sprigs |
| | Sod plugs 3' x3' | | | | | |
| Centipede | Block Sod Only | Block Sod Only | --- | 11/1-5/31 | 11/1-5/31 | Drought tolerant. Full sun or partial shade. |
| Crown Vetch With winter annuals or cool season grasses | 15 lbs. | 0.3 lb. | 9/1-10/15 | 9/1-10/15 | -- | Mix with 30 lbs. Tall Fescue or 15 lbs. Rye; inoculate seed; plant only North of Atlanta. |
| Fescue, Tall Alone With other perennials | 50 lbs. 30 lbs. | 1.1 lbs. 0.7 lb. | 3/1-4/15 or 8/15-10/15 | 9/1-10/15 | --- | Can be mixed with perennial Lespedezas or Crown Vetch; not for droughty soils or heavy use areas |

29

DS3

Table 1. Some Permanent Plant Species, Seeding Rates, and Planting Dates (continued)

| Species | Rates per Acre | Rates per 1,000 sq. ft | Planting Dates by Region | | | Remarks |
|--------------------|----------------|------------------------|--------------------------|-----------|------------|---|
| | | | M- L | P | C | |
| Lespedeza, Sericea | | | | | | |
| Scarified | 60 lbs. | 1.4 lbs. | 4/1-5/31 | 3/15-5/31 | 3/1-5/15 | Widely adapted and low maintenance; takes 2-3 years to establish; inoculate seed with EL inoculant; mix with Weeping lovegrass, Common Bermuda, Bahia or Tall Fescue. |
| Unscarified | 75 lbs. | 1.7 lbs. | 9/1-2/28 | 9/1-2/28 | 9/1-2/28 | Mix with Tall Fescue or winter annuals. |
| Seed-bearing hay | 3 tons | 138 lbs. | 10/1-2/28 | 10/1-1/31 | 10/15-1/15 | Cut when seed is mature but before it shatters. Add Tall Fescue or winter annuals. |

Table 1. Some Permanent Plant Species, Seeding Rates, and Planting Dates (continued)

| Species | Rates per Acre | Rates per 1,000 sq. ft | Planting Dates by Region | | | Remarks |
|---|-----------------|------------------------|--------------------------|-----------|------------|--|
| | | | M- L | P | C | |
| Lespedeza Ambro Virgata or Appalow | | | | | | Spreading growth with height of 18"-24"; good in urban areas; slow to develop good stands; mix with Weeping Lovegrass, Common Bermuda, Bahia Tall Fescue or winter annuals; do not mix with Sericea Lespedeza; inoculate seed with EL inoculant. |
| Scarified | 60 lbs. | 1.4 lbs. | 4/1-5/31 | 3/15-5/31 | 3/1-5/15 | |
| Unscarified | 75 lbs. | 1.7 lbs. | 9/1-2/28 | 9/1-2/28 | 9/1-2/28 | |
| Lespedeza, Shrub (Lespedeza Bicolor or Lespedeza Thumbergii) Plants | 3' x 3' spacing | | 10/1-3/31 | 11/1-3/15 | 11/15-2/28 | Plant in small clumps for wildlife food and cover. |

31

DS3

Table 1. Some Permanent Plant Species, Seeding Rates, and Planting Dates (continued)

| Species | Rates per Acre | Rates per 1,000 sq. ft | Planting Dates by Region | | | Remarks |
|--|--------------------|------------------------|--------------------------|-----------|----------|---|
| | | | M- L | P | C | |
| Lovegrass, weeping Alone With other perennials | 4 lbs. 2 lbs. | 0.1 lb. 0.05 lb. | 4/1-5/31 | 3/15-5/31 | 3/1-5/31 | Quick cover; drought tolerant; grows well with Sericea Lespedeza on road-banks and other steep slopes; short lived. |
| Maidencane sprigs | 2' x 3' spacing | | 2/1-3/31 | 2/1-3/31 | 2/1-3/31 | For very wet sites such as river banks and shorelines. Dig sprigs locally. |
| Panicgrass, Atlantic Coastal | 20 lbs. | 0.5 lb. | --- | 3/1-4/30 | 3/1-4/30 | Grows well on coastal sand dunes; mix with Sericea Lespedeza but not on sand dune. |
| Red Canary Grass With other perennials | 50 lbs. 30 lbs. | 1.1 lbs. 0.7 lb. | 8/15-10/15 | 9/1-10/15 | — | Grows similar to Tall Fescue; for wet sites |

32

DS3

Table 1. Some Permanent Plant Species, Seeding Rates, and Planting Dates (continued)

| Species | Rates per Acre | Rates per 1,000 sq. ft | Planting Dates by Region | | | Remarks |
|------------------------------|----------------|------------------------|--------------------------|-----------|----------|---|
| | | | M- L | P | C | |
| Sunflower, Aztec Maximillian | 10 lbs. | 0.2 lb. | 4/15-5/31 | 4/15-5/31 | 4/1-5/31 | Mix with Weeping Lovegrass or other low growing grasses or legumes. |

1. Rates are for broadcasted seed. If a seed drill is used, reduce the rates by one-half.
2. PLS is an abbreviation for Pure Live Seed. Refer to Glossary for an explanation of this term.
3. The resource areas are defined in the Glossary. See page 60 for Resource Area.
4. Seeding rates are based on pure live seeds (PLS).

Table 2. Fertilizer Requirements for Permanent Vegetation

| Types of Species | Planting Year | Fertilizer (N-P-K) | Rate (lbs./ acre) | N Top Dressing Rate (lbs./acre) |
|---------------------------------|---------------|--------------------|-------------------|---------------------------------|
| Cool season grasses | First | 6-12-12 | 1500 | 50-100 |
| | Second | 6-12-12 | 1000 | --- |
| | Maintenance | 10-10-10 | 400 | 30 |
| Cool grasses and legumes | First | 6-12-12 | 1500 | 0-50 |
| | Second | 0-10-10 | 1000 | --- |
| | Maintenance | 0-10-10 | 400 | --- |
| Warm season grasses | First | 6-12-12 | 1500 | 50-100 |
| | Second | 6-12-12 | 800 | 50-100 |
| | Maintenance | 10-10-10 | 400 | 30 |
| Warm season grasses and legumes | First | 6-12-12 | 1500 | 50 |
| | Second | 0-10-10 | 1000 | --- |
| | Maintenance | 0-10-10 | 400 | --- |

(This page left blank intentionally.)



Figure 2. Weeping Lovegrass



Figure 3. Sericea Lespedeza



Figure 4. Common Bermuda

MAINTENANCE

- Re-seed areas where an adequate stand of vegetation fails to emerge or where a poor stand exists.
- Maintain at least 6" of top growth under any use and management.
- Exclude traffic until the plants are well established.
- Please refer to Table 2 for second year and maintenance fertilizer rates.
- Apply one ton of agricultural lime every 4-6 years or as indicated by soil tests.
- Mow Bermudagrass, Bahiagrass, and Tall Fescue as desired.
- Mow Sericea Lespedeza only after frost to ensure that the seeds are mature.

REFERENCES

- Ds1** Disturbed Area Stabilization
(With Mulching Only)
- Ds2** Disturbed Area Stabilization
(With Temporary Seeding)
- Ss** Slope Stabilization

Ds4

DISTURBED AREA STABILIZATION (WITH SODDING)

DEFINITION

A permanent vegetative cover using sods on highly erodible or critically eroded lands.



PURPOSE

- Establish immediate ground cover
- Reduce runoff and erosion
- Improve aesthetics and land value
- Reduce dust and sediments
- Stabilize waterways and critical areas
- Filter sediments, nutrients and bugs
- Reduce downstream complaints
- Reduce likelihood of legal action
- Reduce likelihood of work stoppage due to legal action
- Increase “good neighbor” benefits

INSTALLATION

- Bring soil surface to final grade. Clear surface of trash, woody debris, stones and clods larger than 1”. Apply sod to soil surfaces only and not frozen surfaces, or gravel type soils.

- Topsoil properly applied will help guarantee a stand. Don't use topsoil recently treated with herbicides or soil sterilants.
- Mix fertilizer into soil surface. Fertilize based on soil tests or Table 1. For fall planting of warm season species, half the fertilizer should be applied at planting and the other half in the spring.
- Agricultural lime should be applied based on soil tests or at a rate of 1-2 tons/acre.
- Lay sod with tight joints and in straight lines. Don't overlap joints. Stagger joints and do not stretch sod.

| Fertilizer Type (lbs./acre) | Fertilizer Rate (lbs./sq.ft.) | Fertilizer Rate | Season |
|-----------------------------|-------------------------------|-----------------|--------|
| 10-10-10 | 1000 | .025 | Fall |

- On slopes steeper than 3:1, sod should be anchored with pins or other approved methods.
- Installed sod should be rolled or tamped to provide good contact between sod and soil.
- Irrigate sod and soil to a depth of 4" immediately after installation.
- Sod should not be cut or spread in extremely wet or dry weather.
- Irrigation should be used to supplement rainfall for a minimum of 2-3 weeks.

MATERIALS

- Sod selected should be certified. Sod grown in the general area of the project is desirable.
- Sod should be machine cut and contain 3/4" (+ or - 1/4") of soil, not including shoots or thatch.

Ds4

- Sod should be cut to the desired size within $\pm 5\%$. Torn or uneven pads should be rejected.
- Sod should be cut and installed within 36 hours of digging.
- Avoid planting when subject to frost heave or hot weather, if irrigation is not available.
- The sod type should be shown on the plans or installed according to Table 2. See page 60 for your Resource Area.

| Grass | Varieties | Resource Area | Growing Season |
|---------------|---|-------------------------------|----------------|
| Bermudagrass | Common Tifway Tifgreen Tiflawn | M-L, P,C P,C P,C P,C | Warm weather |
| Bahiagrass | Pensacola | P,C | Warm weather |
| Centipede | — | P,C | Warm weather |
| St. Augustine | Common Bitterblue Raleigh | C | Warm weather |
| Zoysia | Emerald Myer | P,C | Warm weather |
| Tall Fescue | Kentucky 31 | M-L, P | Cool weather |

MAINTENANCE

- Re-sod areas where an adequate stand of sod is not obtained.
- New sod should be mowed sparingly. Grass height should not be cut less than 2"-3" or as specified.
- Apply one ton of agricultural lime as indicated by soil test or every 4-6 years.

- Fertilize grasses in accordance with soil tests or Table 3.

| Table 3. Fertilizer Requirements for Sod | | | | |
|--|---------------|--------------------|------------------|--|
| Types of Species | Planting Year | Fertilizer (N-P-K) | Rate (lbs./acre) | Nitrogen Top Dressing Rate (lbs./acre) |
| Cool season grasses | First | 6-12-12 | 1500 | 50-100 |
| | Second | 6-12-12 | 1000 | --- |
| | Maintenance | 10-10-10 | 400 | 30 |
| Warm season grassed | First | 6-12-12 | 1500 | 50-100 |
| | Second | 6-12-12 | 800 | 50-100 |
| | Maintenance | 10-10-10 | 400 | 30 |

REFERENCES

- Ds1** Disturbed Area Stabilization (With Mulching Only)
- Ds2** Disturbed Area Stabilization (With Temporary Seeding)
- Ds3** Disturbed Area Stabilization (With Permanent Vegetation)
- Ss** Slope Stabilization

DUST CONTROL ON DISTURBED AREAS

DEFINITION

Controlling surface and air movement of dust on construction sites, roads, and demolition sites.



PURPOSE

- Prevent surface and air movement of dust from exposed soil surfaces.
- Reduce the presence of airborne substances that may be harmful or injurious to human health, welfare, or safety, or to animals or plant life.

MATERIALS

Temporary Methods

- Mulches - See **Ds1 - Disturbed Area Stabilization** (with Mulching only). Refer to specification **Tac - Tackifiers** for the use of synthetic resin to bind mulch material.
- Vegetative Cover - See **Ds2 - Disturbed Area Stabilization** (with Temporary Seeding).
- Spray-on Adhesives - For use on mineral soils, not muck soils. Refer to specification **Tac - Tackifiers**.

- Tillage - Designed to roughen and bring clods to the soil surface. Begin plowing on windward side of site. Use chisel-type plows, spring-toothed harrows, or similar plows to achieve desired effect. This is an emergency measure to be used before wind erosion starts.
- Irrigation - Sprinkle the site with water until the surface is wet. Repeat as needed.
- Barriers - Use solid board fence, snow fence, burlap fence, crate walls, bales of hay, or similar material to control air currents and soil blowing. Place barriers at right angles at intervals of 15x their height to control wind erosion.
- Calcium Chloride - Apply at a rate to keep the surface moist.

Permanent Methods

- Permanent Vegetation - See **Ds3 - Disturbed Area Stabilization** (with Permanent seeding). Existing trees and large shrubs may afford valuable protection if left in place.
- Topsoiling - See specification **Tp - Topsoiling**.
- Stone - Cover surface with crushed stone or coarse gravel. See specification **Cr - Construction Road Stabilization**.

MAINTENANCE

- Prohibit traffic on surface after spraying.
- Supplement surface covering as needed.

REFERENCES

- Ds1** Disturbed Area Stabilization
(With Mulching Only)
- Ds2** Disturbed Area Stabilization
(With Temporary Seeding)
- Ds3** Disturbed Area Stabilization
(With Permanent Vegetation)
- Ds4** Disturbed Area Stabilization
(With Sodding)
- Tac** Tackifiers
- Cr** Construction Road Stabilization
- Tp** Topsoiling

(This page left blank intentionally.)

DEFINITION

Formulated to assist in the solids/liquid separation of suspended particles in solution.

Coagulant - Required to help give body to the water. A coagulant neutralizes the repulsive electrical charges surrounding particles allowing them to “stick together” creating clumps or flocs that form a small to mid-size particle.

Flocculent - Facilitate the agglomeration or aggregation of the coagulated particles to form larger floccules and act as a net where it gathers up the smaller coagulated particles making a larger particle. This larger particle will slowly drop out of suspension.

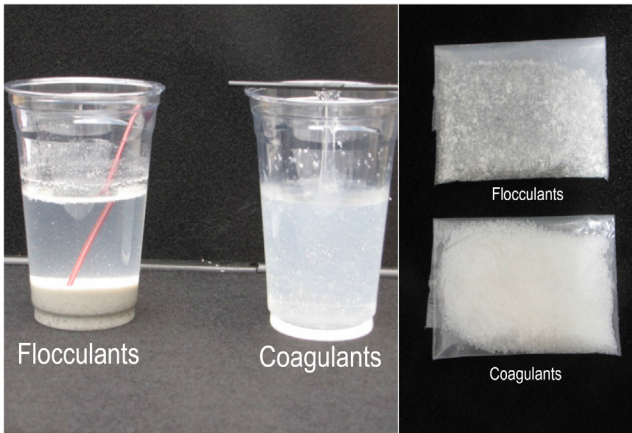

PURPOSE

- Settle suspended sediment, heavy metals and hydrocarbons (TSS) in runoff water from construction sites for water clarification.

INSTALLATION

- Application shall conform to manufacturer’s instructions and guidelines. FI-Co applications shall comply with all federal and local laws.
- Only anionic forms of FI-Co shall be used.

- This practice is not intended for application to surface waters of the state. It is intended for application within construction storm water ditches and storm drainage systems that feed into pre-constructed ponds or basins.

MAINTENANCE

- Maintenance shall consist of reapplying FI-Co via the measures above when turbidity levels are no longer met or the FI-Co is used up. Bricks, blocks, socks, logs and bags shall be maintained when sediment accumulates on the products.

Sb

STREAMBANK STABILIZATION

(USING PERMANENT VEGETATION)

DEFINITION

The use of readily available native plant materials to maintain and enhance streambanks, or to prevent, or restore and repair small streambank erosion problems.



PURPOSE

- Lessen the impact of rain directly on the soil.
- Trap sediment from adjacent land.
- Form a root mat to stabilize and reinforce the soil on the streambank.
- Provide wildlife habitat.
- Enhance the appearance of the stream.
- Lower summertime water temperatures for a healthy aquatic population.

NOTE: Careful thought, planning and execution is required to assure that the streambank stabilization project is done efficiently and correctly. Please refer to GSWCC's [Guidelines for Streambank Restoration](#) for more detailed information.

SELECTED PRACTICES

- Revegetation includes seeding and sodding of grasses, seeding in combination with erosion control fabrics, and the planting of woody vegetation (shrubs and trees).
- Use jute mesh and other geotextiles to aid in soil stabilization and revegetation.

Live Stake

- Fresh, alive woody plant cuttings tamped into the ground as stakes, intended to root and grow into mature shrubs that will stabilize soils and restore the riparian zone habitats.
- Willow species work best.
- Provides no immediate streambank stabilization.

LIVE STAKING CROSS-SECTION

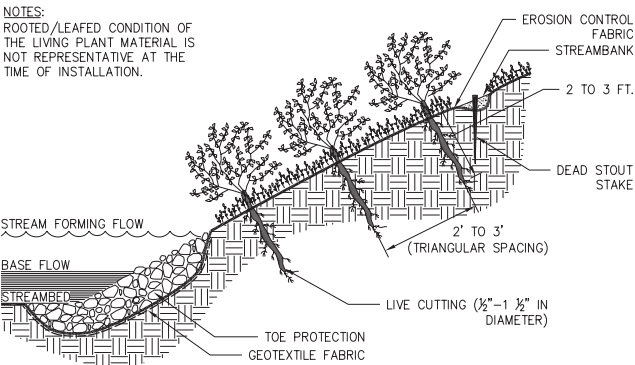

Figure 1. Illustration of a Live Stake

Joint Planting

- Installation of live willow stakes between rock previously placed along the streambank.
- Rock needs to be loosely dumped or hand placed and no thicker than 2 ft.
- Enables a bank previously installed with conventional rip-rap to become naturalized.

NOTES:

ROOTED/LEAFED CONDITION OF THE LIVING PLANT MATERIAL IS NOT REPRESENTATIVE AT THE TIME OF INSTALLATION.

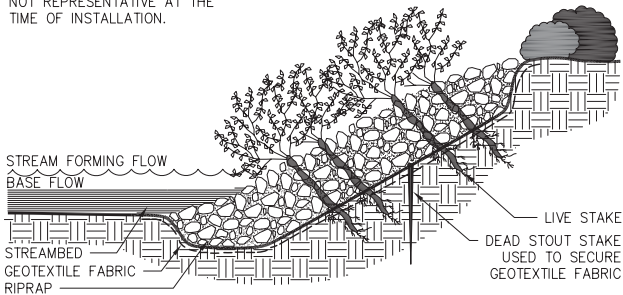

Figure 2. Illustration of Joint Planting

Live Fascine

- Sausage-like bundles of live cut branches placed into trenches along the streambank.
- Willow species work best.
- Provides immediate protection from erosion when properly used and installed.
- Creates very little site disturbance as compared to other systems.
- Works especially well when combined with surface covers such as jute mesh or coir fabrics.

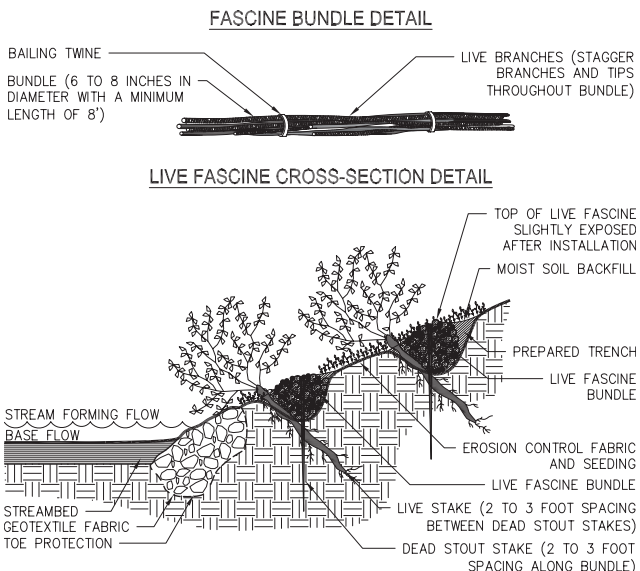

Figure 3. Illustration of a Live Fascine

Brushmattress

- Combination of living units that form an immediate protective surface cover over the streambank.
- Living units used include live stakes, live fascines, and a mattress branch cover (long, flexible branches placed against the bank surface).
- Requires a great deal of live material.
- Complicated and expensive to evaluate, design, and install.
- Captures sediment during flood conditions.
- Produces habitat rapidly, and quickly develops a healthy riparian zone.

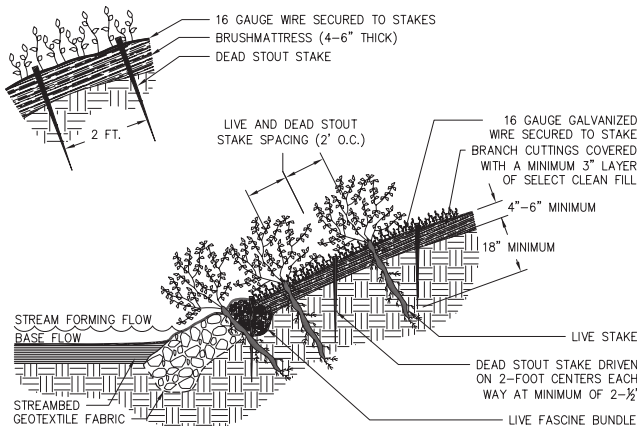

Figure 4. Illustration of a Brushmattress

Live Cribwall

- A rectangular framework of logs or timbers, rock, and woody cuttings.
- Requires a great deal of assessment and understanding of stream behavior.
- Can be complicated and expensive if a supply of wood and some volunteer help is not available.
- Develops a natural streambank or upland slope appearance after it has begun to grow.

- Provides excellent habitat for a variety of fish, birds, and animals.
- Very useful where space is limited on small, narrow stream corridors.

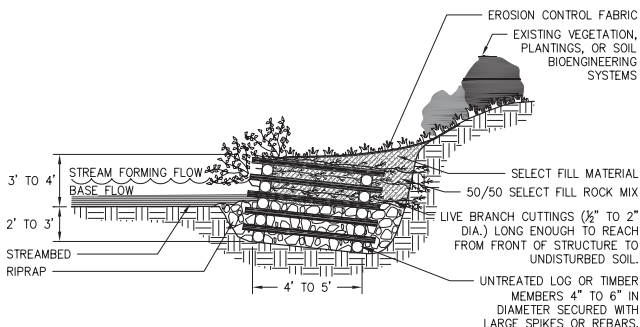

Figure 5. Illustration of a Live Cribwall

Branchpacking

- Process of alternating layers of live branches and soil, incorporated into a hole, gully, or slumped-out area in a slope or streambank.
- Moderate to complex level of difficulty for construction.
- Produces an immediate filter barrier, reducing scouring conditions, repairing gully erosion, and providing habitat cover and bank reinforcement.

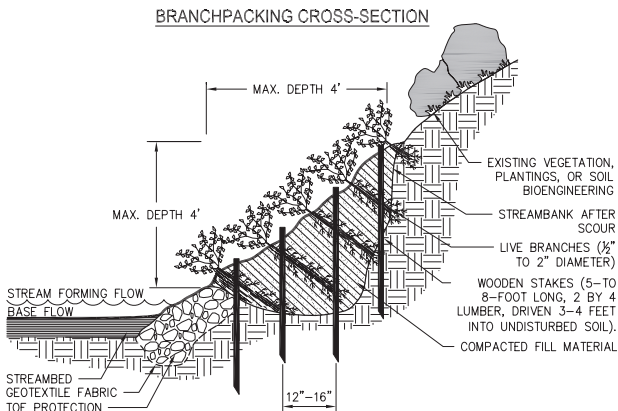

Figure 6. Illustration of Branchpacking

- One of the most effective and inexpensive methods for repairing holes in earthen embankments along small stream sites.

| Table 1. Streambank Erosion Protection Measures Relative Costs Complexity | | |
|---|------------------|---------------------|
| Measure | Relative Cost | Relative Complexity |
| Live stake | Low | Simple |
| Joint planting | Low* | Simple* |
| Live fascine | Moderate | Moderate |
| Brushmattress | Moderate | Moderate to Complex |
| Live cribwall | High | Complex |
| Branchpacking | Moderate | Moderate to Complex |
| Conventional vegetation | Low to Moderate | Simple to Moderate |
| Conventional bank armoring (riprap) | Moderate to High | Moderate to Complex |

*Assumes rock is in place

MAINTENANCE

- Check banks after every high-water event, fixing gaps in the vegetative cover at once with structural materials or new plants, and mulching if necessary.
- Fresh cuttings from other plants may be used for repairs.
- When fertilizer is applied on the surface, it is best to apply about one-half at planting, one-fourth when new growth is about 2" tall, and one-fourth about six weeks later.

REFERENCES

- Ds1** Disturbed Area Stabilization
(With Mulching Only)
- Ds2** Disturbed Area Stabilization
(With Temporary Seeding)
- Ds3** Disturbed Area Stabilization
(With Permanent Vegetation)
- Ds4** Disturbed Area Stabilization
(With Sodding)
- Ss** Slope Stabilization

Guidelines for Streambank Restoration,
Georgia Soil and Water Conservation
Commission

Sb

(This page left blank intentionally.)

SLOPE STABILIZATION

DEFINITION

A protective covering used to prevent erosion and establish temporary or permanent vegetation on steep slopes, shore lines, or channels.

Rolled Erosion Control Products (RECP)

- A natural fiber blanket with single or double photodegradable or biodegradable nets.

Hydraulic Erosion Control Products (HECP)

- HECP shall utilize straw, cotton, wood or other natural based fibers held together by a soil binding agent which works to stabilize soil particles. Paper mulch should not be used for erosion control.



PURPOSE

- Provide a cover layer that stabilizes the soil and acts as a rain drop impact dissipater while providing a microclimate which protects young vegetation and promotes its establishment.

INSTALLATION

- Installation and stapling of RECPs and application rates for the HECPs shall conform to manufacturer's guidelines for application.
- Hydraulic erosion control products shall be prepackaged from the manufacturer. Field mixing of performance enhancing additives will not be allowed. Fibrous components should be all natural or biodegradable.



Figure 1. Hydroseeding on disturbed areas

MAINTENANCE

- Inspect all erosion control blankets and matting periodically after installation. Inspect immediately after rainstorms to check for erosion and undermining.
- Repair all dislocations and failures immediately.
- Re-install all materials after washouts or breakage occurs. Repair damage to the slope or ditch first.
- Monitor all areas until they are permanently stabilized.



Figure 2. Installation of Jute Matting

BLANKET AND MATTING CROSS-SECTIONS

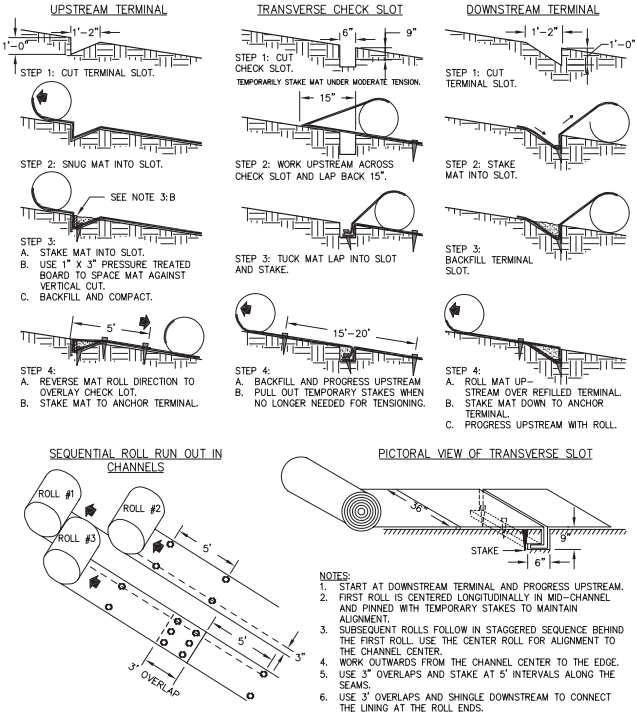

Figure 2. Typical Installation Guidelines for RECP

DEFINITION

A substance used as tie-down for soil, compost, seed, straw, hay or mulch. They hydrate in water and readily blend with other slurry materials to form a homogenous slurry.

**PURPOSE**

The purpose of tackifiers are to reduce soil erosion from wind and water on construction sites. It also increases the performance of the mulching material, so that it can:

- Increase infiltration.
- Increase soil fertility
- Control undesirable vegetation.
- Reduce runoff stormwater turbidity and loss of topsoil.
- Modify soil temperature.
- Increase soil cohesion and stabilization.
- Enhance seed germination

CONDITIONS

This practice is intended for direct soil surface application to sites where the timely establishment of vegetation may not be feasible or where vegetative cover is absent or inadequate.

CRITERIA

- All organic mulching materials shall be anchored by tackifiers/binders or matting/netting. Tackifiers and binders are used to anchor wood cellulose, wood pulp fiber, and other mulch materials applied with hydroseeding equipment.
- Only anionic forms of PAM shall be used. Not harmful to plants, animals, and aquatic life.
- Application rates shall conform to manufacturer's guidelines for application.
- Shall not reduce infiltration rates.
- All organic tackifiers must be derived from natural plant sources.
- Contain no growth or germination inhibiting materials.
- Synthetic fibers shall be of nylon or polyester blends.
- There are 5 types of tackifiers:
 - **Tac-1** Synthetic Polymers
 - **Tac-2** Organic Polymers
 - **Tac-3** Synthetic/Organic Blends
 - **Tac-4** Organic Polymers w/ Synthetic Fibers
 - **Tac-5** Synthetic/Organic Blends w/ Synthetic Fibers

GEORGIA

Major Land Resource Areas

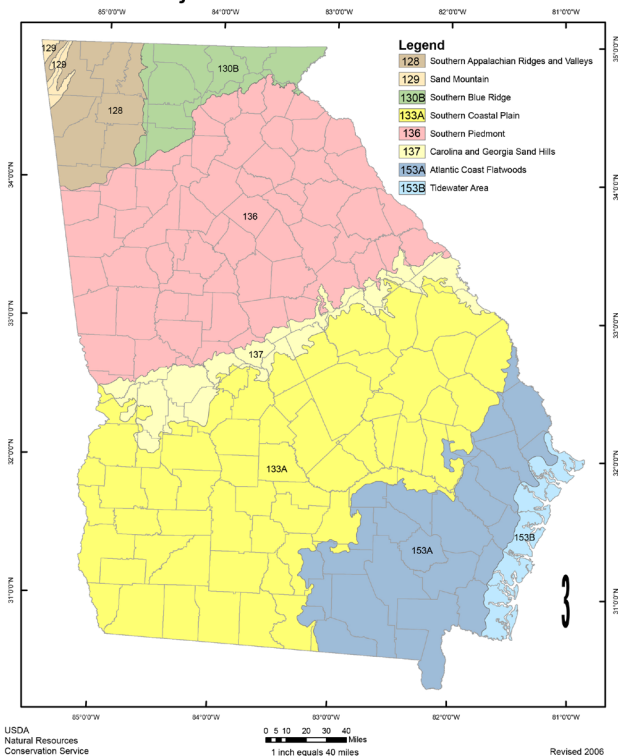

(This page left blank intentionally.)

STRUCTURAL BEST MANAGEMENT PRACTICES

- Cd** Check Dam
- Ch** Channel Stabilization
- Co** Construction Exit
- Cr** Construction Road Stabilization
- Dc** Stream Diversion Channel
- Di** Diversion
- Dn1** Temporary Downdrain Structure
- Dn2** Permanent Downdrain Structure
- Fr** Filter Ring
- Ga** Gabion
- Gr** Grade Stabilization Structure
- Lv** Level Spreader
- Rd** Rock Filter Dam
- Re** Retaining Wall
- Rt** Retrofit
- Sd1** Sediment Barrier
- Sd2** Inlet Sediment Trap
- Sd3** Temporary Sediment Basin
- Sd4** Temporary Sediment Trap
- Sk** Floating Surface Skimmer
- SpB** Seep Berm
- Sr** Temporary Stream Crossing

- St** Storm Drain Outlet Protection
- Su** Surface Roughening
- Tc** Turbidity Curtain
- Tp** Topsoiling
- Tr** Tree Protection
- Wt** Vegetated Waterway or Stormwater Conveyance Channel

The products and practices presented in this Field Manual show the standard installation methods for each conventional BMP. New products and practices may not necessarily meet the requirements for each conventional BMP. Please see the Equivalent Best Management Practice List for specific manufacturer guidelines and specifications.

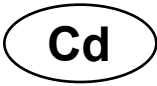

CHECK DAM

DEFINITION

A small temporary barrier constructed across a swale, drainage ditch, or area of concentrated flow.



PURPOSE

- Reduce velocity.
- Filter sediment.
- Stabilize grade.

INSTALLATION

- Install according to the approved plan.
- Place in small, open channels, not in live streams.
- Construct center at least 9" lower than outer edges.
- Extend across entire width of ditch or swale.
- Make side slopes 2:1 or flatter.
- Toe of the upstream dam should be at the same elevation as the top of the downstream dam.
- Seed and mulch area beneath the dam after its removal.
- Check dams may be used in conjunction with other BMPs for any flows exceeding 2.0 cfs.

Stone Check Dams**Cd-S**

- Drainage area not to exceed 2 acres.
- Constructed of graded size 2"-10" stone.
- The center of the check dam should be at least 9" lower than the outer edges.
- The dam height should be a maximum of 2 ft from the center to the rim edge.
- Place a suitable geotextile between the graded stone and the soil base and abutments.

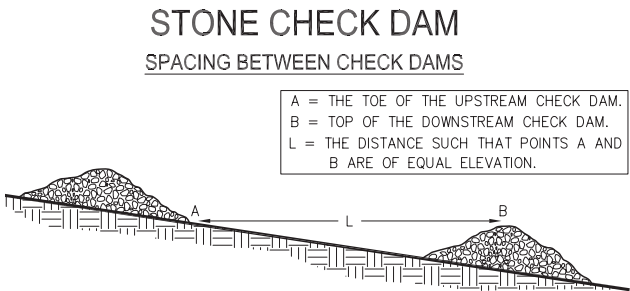
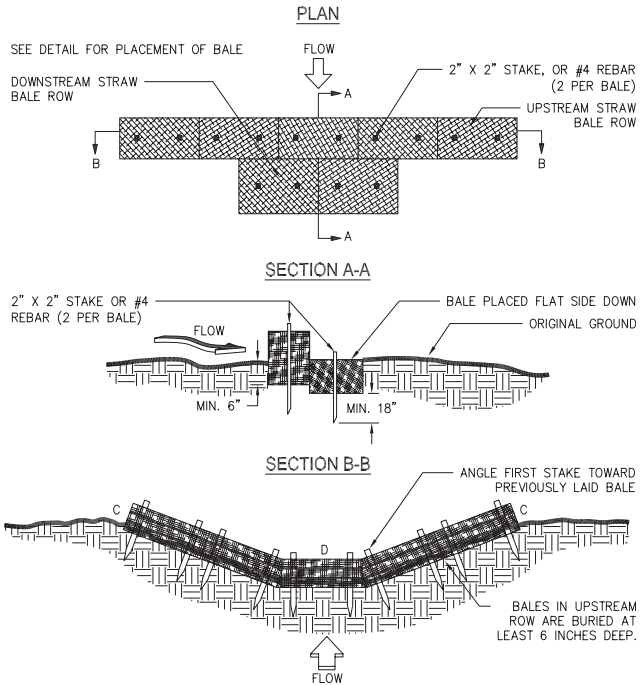

Figure 1. Stone Check Dam Spacing Requirements

Straw Bale Check Dams**Cd-Hb**

- Drainage area not to exceed 1 acre.
- Bales should be bound with wire or nylon string.
- Bales should be placed in rows with bale ends tightly abutting the adjacent bales.
- A trench shall be dug across the channel deep enough that the wide side of the 2nd bale is level with the ground.
- Drive the standard 2x2 stakes or #4 rebar through the bales into the ground 18"-24" for anchorage. The first stake in each bale should be driven toward a previously laid bale in order to force bales together.

Cd



NOTES:

1. BALES SHOULD BE BOUND WITH WIRE OR NYLON STRING AND SHOULD BE PLACED IN ROWS WITH BALE ENDS TIGHTLY ABUTTING THE ADJACENT BALES.
2. REMOVE #4 REBAR AFTER STRAW BALES ARE NO LONGER IN PLACE.
3. POINT C OF SECTION B-B SHOULD ALWAYS BE HIGHER THAN POINT D.

Figure 1. Straw Bale Check Dam Installation Requirements

Compost Filter Sock

Cd-Fs

- Drainage area not to exceed 1 acre.
- Place one stake in the filter sock at the center of the ditch/ channel.
- Place stakes at the bed/bank junction and at the end of the device not spaced more than 2 ft apart.
- Compost filter sock to be at least 18" in diameter
- Minimum staking depth is 18".
- Can be seeded at the time of installation.

COMPOST SOCKS FOR CHECK DAMS

TYPICAL PLAN

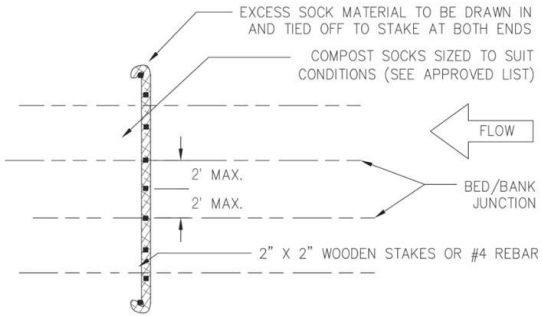

Figure 1. Compost Filter Sock Installation Requirements

MAINTENANCE

- Periodically inspect and maintain all structures.
- Remove sediment when it reaches a depth of one-half the original dam height.
- May remain in place permanently.

REFERENCES

- Ds1** Disturbed Area Stabilization (With Mulching Only)
- Ds2** Disturbed Area Stabilization (With Temporary Seeding)
- Ds3** Disturbed Area Stabilization (With Permanent Vegetation)
- Ds4** Disturbed Area Stabilization (With Sodding)

DEFINITION

Improving, constructing, or stabilizing an open channel or waterway.

**PURPOSE**

- Prevent erosion and sediment deposition.
- Provide adequate capacity for flood water, drainage, or other water management practices.

INSTALLATION

- Install according to the approved plan.
- Drainage area not to exceed one square mile.
- This applies only to channels conveying intermittent flow, not to channels conveying a continuous, live stream.

Category 1 (≤ 5 ft/sec) Ch-1**Vegetative Lining**

- Temporary erosion control blankets or sod shall be used to aid in the establishment of the vegetated lining.
- Hydraulic Erosion Control Products are not intended to be applied in channels, swales, or other areas where concentrated flows are anticipated.

Category 2 (≥ 5 ft/sec to < 10 ft/sec)

Turf Reinforcement Matting (TRM)

- Permanent geosynthetic erosion control matting that is used in channels to stabilize the soil while permanent vegetation is rooting.

Rock Riprap Lining

- Slopes should be 1.5:1 or less.
- Place a filter blanket, at least 6 inches thick, of sand, gravel, and/or geotextile material between the riprap and the base material.

Category 3 (≥ 10 ft/sec)

Concrete Lining

- A separation geotextile should be placed under concrete linings to prevent undermining.
- Provide adequate outlet protection for discharge point.

Grade Stabilization Structure

- Constructed of concrete, rock, masonry, steel, aluminum or treated wood.
- Provide adequate outlet for discharge.
- Do not compromise the environmental integrity of the area.
- Vegetate all disturbed areas immediately.



Figure 1. Concrete Lining

Ch

MAINTENANCE

- Periodically inspect and maintain all structures.

REFERENCES

- Gr** Grade Stabilization Structure
- St** Storm Drain Outlet Protection
- Ds1** Disturbed Area Stabilization
(With Mulching Only)
- Ds2** Disturbed Area Stabilization
(With Temporary Seeding)
- Ds3** Disturbed Area Stabilization
(With Permanent Vegetation)
- Ds4** Disturbed Area Stabilization
(With Sodding)

Ch

(This page left blank intentionally.)

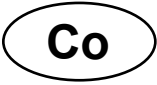

CONSTRUCTION EXIT

DEFINITION

A stone-stabilized pad located at any point where traffic will be leaving a construction site to a public right-of-way, street, alley, sidewalk, or parking area.



PURPOSE

- Reduce or eliminate the transport of mud from the construction area onto public right-of-ways.

INSTALLATION

- Install according to the approved plan.
- Use 1.5"-3.5" stone.
- Minimum pad thickness of 6".
- Minimum pad width of 20 ft.
- Minimum pad length of 50 ft.
- When the construction is less than 50 ft from the paved access, the length shall be from the edge of the existing pavement to the permitted building being constructed.
- When washing is required, conduct on an area stabilized with crushed stone and route runoff to an approved sediment trap or sediment basin.
- Place the geotextile liner the full length and width of the entrance.

CRUSHED STONE CONSTRUCTION EXIT

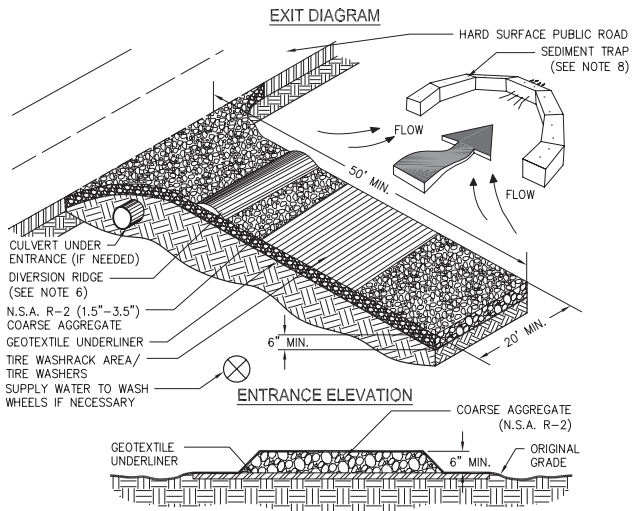

Figure 1. Crushed Stone Construction Exit Installation Requirements



Figure 2. Geotextile Underliner

MAINTENANCE

- Periodically dress with 1.5"-3.5" stone.
- Maintain in a condition that will prevent tracking or flow of mud onto public rights-of way.
- Immediately remove mud and debris tracked or spilled onto roadways.

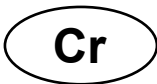

CONSTRUCTION ROAD STABILIZATION

DEFINITION

A travel way constructed as part of a construction plan including access roads, subdivision roads, parking areas, and other on-site vehicle transportation routes.



PURPOSE

- Provide a fixed route of travel for construction traffic.
- Reduce erosion and subsequent regrading of permanent roadbeds between time of initial grading and final stabilization.

INSTALLATION

- Install according to the approved plan.
- Temporary roads shall follow the contours of the natural terrain to minimize disturbance of drainage patterns.
- If a temporary road must cross a stream, the crossing must be designed, installed and maintained according to specification **Sr - Temporary Stream Crossing**.
- Grades for temporary roads should not exceed 10% except for short lengths but maximum grades of 20% or more may be used for special uses.

- Temporary roadbeds shall be at least 14 ft wide for one-way traffic, 20 ft wide for two-way traffic. The width for two-way traffic shall be increased approximately 4 ft for trailer traffic.
- Provide a minimum shoulder width of 2 ft on each side.
- All cut and fills shall be 2:1 or flatter. Side slopes shall be no steeper than 3:1 if mowing
- Drainage channels shall be designed to be on stable grades or protected with structures or linings for stability.
- Apply geotextile to the roadbed for additional stability according to the design manual specifications.
- Apply a 6" layer of coarse aggregate immediately after grading. For "heavy-duty" traffic situations, place stone at a depth of 8"-10".
- Stabilize all roadside ditches, cuts, fills, and other disturbed areas adjacent to parking areas and roads with appropriate temporary or permanent vegetation

MAINTENANCE

- Periodically top dress roads and parking areas with gravel to maintain the gravel depth at 6".
- Check vegetated areas periodically to ensure a good stand of vegetation is maintained.
- Remove any silt or other debris causing clogging of roadside.

REFERENCES

Ds2Disturbed Area Stabilization
(With Temporary Seeding)**Ds3**Disturbed Area Stabilization
(With Permanent Vegetation)**Sr**

Temporary Stream Crossing



STREAM DIVERSION CHANNEL

DEFINITION

A temporary channel constructed to convey flow around a construction site while a permanent structure is being constructed in the stream channel.



PURPOSE

- Protect the streambed from erosion and allow work “in the dry”.

INSTALLATION

- Install according to the approved plan.
- Drainage area shall not exceed one square mile (640 acres).
- The bottom width of the stream diversion shall be a minimum of six feet or equal to the bottom width of the existing streambed, whichever is greater.
- Side slopes of the stream diversion channel shall be no steeper than 2:1.
- Depth and grade of the channel shall be sufficient to ensure continuous flow of water in the diversion.
- The channel shall be lined to prevent erosion of the channel and sedimentation in the stream.
- The lining is selected based upon the expected velocity of bankfull flow. Please refer to Table 1.

| Table 1. Stream Diversion Channel Linings | | |
|---|-------------|---------------------------|
| Lining Materials | Symbol | Acceptable Velocity Range |
| Geotextile, polyethylene film, or sod | Dc-A | 0-2.5 fps |
| Geotextile alone | Dc-B | 2.5-9.0 fps |
| Class I RipRap & Geotextile | Dc-C | 9.0-13.0 fps |

STREAM DIVERSION CHANNEL

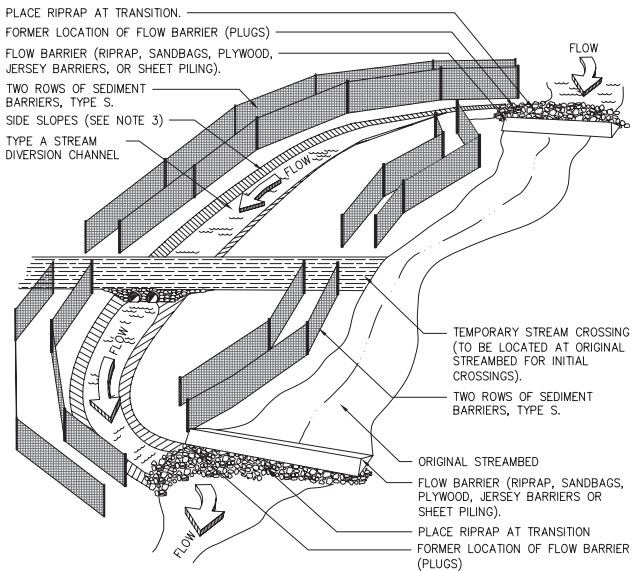

**Figure 1. Stream Diversion Channel
(Perspective View)**

Dc

- The channel shall be excavated, constructing plugs at both ends.
- Sediment barriers or berms shall be placed along the sides of the channel to prevent unfiltered runoff from entering the stream.
- The channel surface shall be smooth (to prevent tearing of the liner) and lined with the material specified in the plans.
- The plugs are removed when the liner installation is complete, removing the downstream plug first.
- As soon as construction in the streambed is complete, the diversion shall be replugged and backfilled.
- Upon removal of the lining, the stream shall immediately be restored and properly stabilized.
- A Stream Buffer Variance from the GA EPD may be required and all other appropriate agencies, including the U.S. Army Corps of Engineers, must be contacted to ensure compliance with other laws.

MAINTENANCE

- Inspect the stream diversion channel at the end of each day to make sure that the construction materials are positioned securely.
- Ensure that the work area stays dry and that no construction materials float downstream.
- All repairs shall be made immediately.

REFERENCES

Ss

Slope Stabilization

Dc

(This page left blank intentionally.)

DEFINITION

A ridge of compacted soil, constructed above, across, or below a slope.

**PURPOSE**

- Reduce slope lengths.
- Intercept and divert storm runoff to a stable outlet at a non-erosive velocity.

INSTALLATION

- Install according to the approved plan.
- Remove trees, brush, stumps and other objectionable material.
- Compact all fills.
- Channel cross-section should be trapezoidal or parabolic in shape.
- Side slopes should be 2:1 or flatter.
- Excavate narrow, deep channels on steep slopes and broad, shallow channels on gentle slopes.
- Adequate outlet must be present.
- Stabilize channel and outlet with vegetation (mulch required for all seeded or sprigged channels), riprap, or concrete.
- Dispose of and/or stabilize unneeded excavated material.

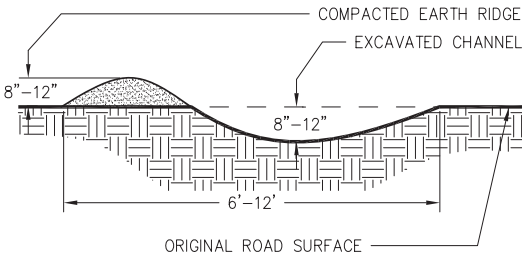

Figure 1. Typical Diversion Across Road

MAINTENANCE

- Inspect frequently and after each rainfall and make necessary repairs.

REFERENCES

Ds1

Disturbed Area Stabilization
(With Mulching Only)

Ds2

Disturbed Area Stabilization
(With Temporary Seeding)

Ds3

Disturbed Area Stabilization
(With Permanent Vegetation)

Ds4

Disturbed Area Stabilization
(With Sodding)

Ch

Channel Stabilization

Dn1

TEMPORARY DOWNDRAIN STRUCTURE

DEFINITION

A temporary structure used to convey storm water down the face of cut or fill slopes.



PURPOSE

- Transport storm runoff from one elevation to another.
- Reduce slope erosion.

INSTALLATION

- Install according to the approved plan.
- Install heavy-duty, flexible materials such as non-perforated, corrugated plastic pipe, or specifically designed flexible tubing.
- Place on undisturbed soil or well-compacted fill.
- Slightly slope the section of pipe under the dike toward its outlet.
- Install Tee, “L” or flared end section inlet at the top of the slope.
- Slope the entrance 1/2” per foot toward outlet.
- Compact a dike ridge no less than 1 ft above the top of the pipe.
- Use reinforced, hold-down grommets or stakes to anchor the pipe at intervals not to exceed 10 ft.

Table 1. Pipe Diameter for Temporary
Downdrain

| Maximum Drainage Area per Pipe (acres) | Pipe Diameter (inches) |
|---|-----------------------------------|
| 0.3 | 10 |
| 0.5 | 12 |
| 1.0 | 18 |

- Ensure that fill over the drain at the top of the slope meets the minimum dimensions.
- Ensure connections are watertight.
- Extend pipe beyond the toe of the slope.
- For steep slopes, drains should be placed diagonally across the slope.
- Curve the outlet uphill.
- Stabilize outlet with rock riprap. A Tee outlet, flared end section, or other suitable device may be used for additional protection.
- Direct all flows into a sediment trap if drains convey sediment-laden runoff.
- Stabilize all disturbed areas immediately.

MAINTENANCE

- Inspect drain and diversion after every rainfall and promptly make necessary repairs.
- Remove once the protected area has been stabilized and the permanent water disposal system is fully functional.

REFERENCES

St

Storm Drain Outlet Protection

Dn1

DOWNDRAIN PIPE AND INLET DETAIL

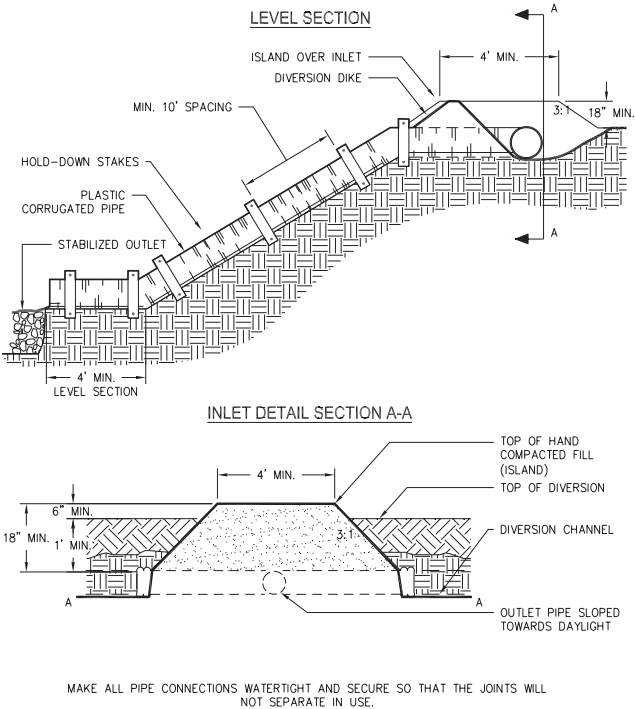

Figure 1. Temporary Downdrain and Inlet Detail



Figure 2. Diagonally Placed Downdrain

Dn1

(This page left blank intentionally.)

Dn2

PERMANENT DOWNDRAIN STRUCTURE

DEFINITION

A permanent structure to safely convey surface runoff from the top of a slope to the bottom of the slope.



PURPOSE

- Convey storm runoff safely down cut or fill slopes to minimize erosion.

INSTALLATION

- Install according to the approved plan.
- Slopes must have sufficient grade to prevent sediment deposition.
- Stabilize outlet according to plan.
- Vegetate all disturbed areas immediately.

Types of Structures

- Paved flume - parabolic, rectangular, or trapezoidal cross section.
- Pipe - steel, plastic, etc.
- Sectional - a prefabricated sectional conduit of half-round or third-round pipe.

MAINTENANCE

- Inspect periodically and maintain structure after each rainfall.

REFERENCES

- | | |
|------------|---|
| Ds1 | Disturbed Area Stabilization (With Mulching Only) |
| Ds2 | Disturbed Area Stabilization (With Temporary Seeding) |
| Ds3 | Disturbed Area Stabilization (With Permanent Vegetation) |
| Ds4 | Disturbed Area Stabilization (With Sodding) |
| St | Storm Drain Outlet Protection |

Fr

FILTER RING

DEFINITION

A temporary stone barrier constructed at storm drain inlets and pond outlets.



PURPOSE

- Reduce flow velocity.
- Prevent the failure of other sediment control devices.
- Prevent sediment from leaving the site or entering drainage systems.

INSTALLATION

- Install according to the approved plan.
- Use in conjunction with other sediment control measures, except where other practices defined in this Manual are not appropriate.
- Surround all sides of the structure receiving runoff from disturbed areas.
- Place the ring a minimum of 4 ft from the structure.
- If the ring is utilized above a retrofit structure, place a minimum of 8-10 ft from the retrofit.
- When utilized at inlets with diameters less than 12", the filter ring shall be constructed of stone no smaller than 3"-5" (15-30 lbs).

- When utilized at pipes with diameters greater than 12", the filter ring shall be constructed of stone no smaller than 10"-15" (50-100 lbs).
- Construct the ring at a height no less than 2 ft above grade.
- Mechanically or hand place the stone uniformly around the structure.

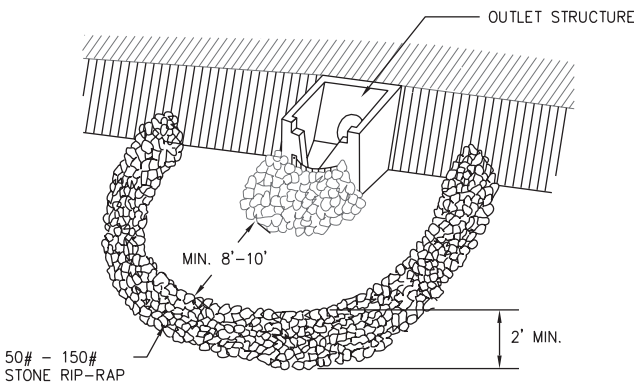

Figure 1. Filter Ring Placement

MAINTENANCE

- Keep clear of trash and debris.
- Continuously monitor and maintain the structure.
- Remove sediment when it reaches one-half full.
- Remove structure when the project has reached final stabilization.

REFERENCES

- Rt** Retrofit
- Sd3** Temporary Sediment Basin
- St** Storm Drain Outlet Protection

DEFINITION

Large, multi-celled, welded wire or rectangular wire mesh boxes, used in channel revetments, retaining walls, abutments, check dams, etc.

**PURPOSE**

- Construction of erosion control structures.
- Stabilize steep or highly erosive slopes.

INSTALLATION

- Install according to the approved plan.
- Foundations must be smooth and level.
- Use only galvanized or PVC coated wire. For highly corrosive conditions, the PVC coating must be used over the galvanizing.
- Set individual baskets into place, wire them together in courses, and fill with rock to form flexible monolithic building blocks.
- Rock should be durable and adequately sized (typically 4"-8") to be retained in the baskets.
- Hand-pack the basket in order to completely fill.
- "Key" structure securely into foundations and abutment surfaces.
- Geotextiles should be used behind all gabion structures.

MAINTENANCE

- Periodically inspect for signs of undercutting or excessive erosion at transition areas.
- Make any necessary repairs immediately.



GRADE STABILIZATION STRUCTURE

DEFINITION

A structure to stabilize the grade in natural or artificial channels.



PURPOSE

- Stabilize the grade in natural or artificial channels.
- Prevent the formation or advancement of gullies.
- Reduce erosion and sediment pollution.

INSTALLATION

- Install according to the approved plan.
- Construct with concrete, rock, masonry, steel, aluminum, or treated wood or by soil bioengineering methods.
- Dewater excavations prior to filling.
- Construct embankment with a minimum top width of 10 ft and side slopes of 3:1 or flatter.
- Construct materials in 6"-8" horizontal lifts
- Place structure on compacted earth-fill. Compact fill to approximately 95% of standard density.
- Construct keyway 8 or more ft wide and 2 ft deep along centerline of the structure and embankment.
- Provide adequate outlet for discharge.

- Place geotextile, such as revetment mats and riprap, under stabilization structure.
- Apply protective cover immediately after completion of the structure.
- Vegetate all disturbed areas immediately.
- All appropriate agencies, including the GAEPD & U.S. Army Corps of Engineers, must be contacted to ensure compliance with other Laws.

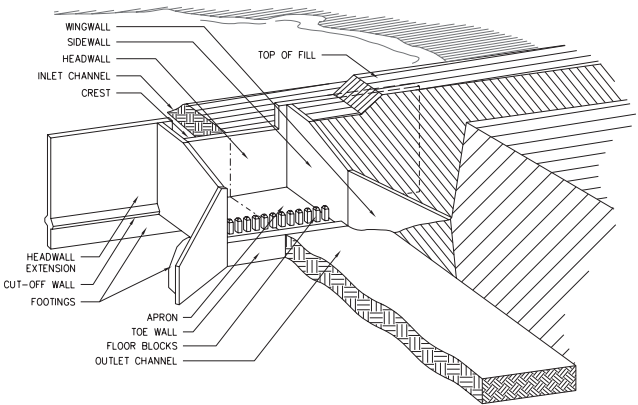

Figure 1. Straight Drop Spillway Structure

MAINTENANCE

- Periodically inspect and maintain all structures.

REFERENCES

- St** Storm Drain Outlet Protection
- Ds1** Disturbed Area Stabilization (With Mulching Only)
- Ds2** Disturbed Area Stabilization (With Temporary Seeding)
- Ds3** Disturbed Area Stabilization (With Permanent Vegetation)
- Ds4** Disturbed Area Stabilization (With Sodding)



LEVEL SPREADER

DEFINITION

A storm flow outlet device constructed at zero grade across the slope whereby concentrated runoff may be discharged at non-erosive velocities onto undisturbed areas stabilized by existing vegetation.



PURPOSE

- Dissipate storm flow energy at the outlet.
- Convert storm runoff into sheet flow.
- Discharge storm runoff onto areas stabilized by existing vegetation.

INSTALLATION

- Install according to the approved plan.
- Grade the channel no greater than 1% for the last 15 ft of the dike or diversion.
- Construct on undisturbed soil that is stabilized with vegetation.
- Minimum width of 6 ft.
- The depth of the level spreader from the lip shall be a minimum of 6”.
- The depth shall be uniform across the entire length.

- Construct level lip at 0% grade.
- Discharge converted sheet flow onto undisturbed stabilized areas.
- Provide a smooth outlet.
- Prevent water from concentrating below point of discharge.
- Vegetate all disturbed areas immediately.

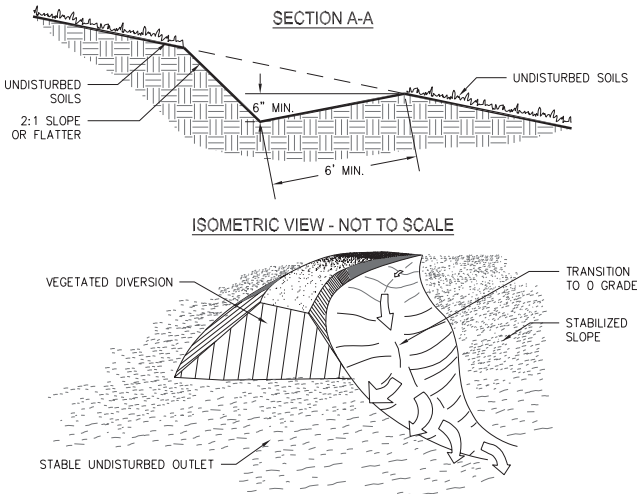

Figure 1. Level Spreader Installation Requirements

MAINTENANCE

- Periodically inspect and maintain all structures.

REFERENCES

- Ds1** Disturbed Area Stabilization (With Mulching Only)
- Ds2** Disturbed Area Stabilization (With Temporary Seeding)
- Ds3** Disturbed Area Stabilization (With Permanent Vegetation)
- Ds4** Disturbed Area Stabilization (With Sodding)



ROCK FILTER DAM

DEFINITION

A temporary stone filter dam installed across drainageways or in conjunction with a temporary sediment trap.



PURPOSE

- Serve as a sediment filtering device.
- Reduce velocity of stormwater flow through a channel.
- Not intended to substantially impound water.

INSTALLATION

- Install according to the approved plan.
- The drainage area shall not exceed 50 acres.
- Must be used in conjunction with other appropriate sediment control measures.
- The dam should be located as close to the source of sediment as possible.
- The dam should not be higher than the channel banks or exceed the elevation of the upstream property line.
- The center of the dam should be at least 9” lower than the outer edges of the dam at the channel banks.

- Side slopes should be 2:1 or flatter.
- The width across the top should be 6 ft or greater.
- Refer to plan for stone size.
- Geotextiles should be used as a separator between the graded stone, soil base, and abutments.
- Extend completely across the channel and securely tie into both channel banks.
- All other appropriate agencies, including the GAEPD & U.S. Army Corps of Engineers, must be contacted to ensure compliance with other Laws.

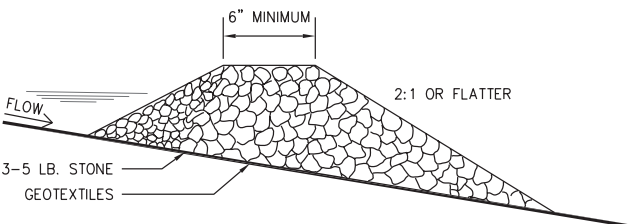
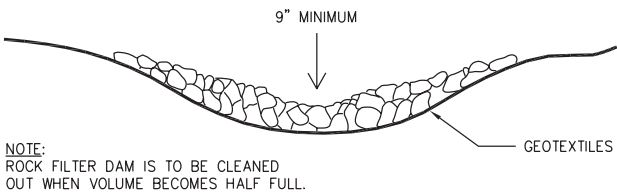

Figure 1. Rock Filter Dam Installation Requirements

MAINTENANCE

- Periodically inspect and maintain all structures.
- Remove sediment when it reaches a depth of one-half of the original height of the dam.
- Remove once disturbed areas have been stabilized.



RETAINING WALL

DEFINITION

A constructed wall of one or more of the following: concrete masonry, reinforced concrete cribbing, treated timbers, steel pilings, gabions, stone drywall, rock riprap, etc.



PURPOSE

- Assist in stabilizing cut or fill slopes where stable slopes are not obtainable without the use of a wall.

INSTALLATION

- Retaining walls require a specific design that is within the capabilities of the design professional.
- Many factors must be taken into account during the design process.
- Close supervision is required to ensure proper installation.
- Depending on the Local Issuing Authority's ordinance, a design professional certificate may be required prior to construction.

Re

(This page left blank intentionally.)

Rt

RETROFIT

DEFINITION

A device or structure placed in front of a permanent stormwater detention pond outlet or roadway drainage structure to serve as a temporary sediment filter.



PURPOSE

- Allows a permanent stormwater detention basin structure to function as a temporary sediment retention basins.
- Allows a roadway drainage structure to be used for temporary sediment storage.

INSTALLATION

- Install according to the approved plan.
- Prohibited in basins on live streams.
- The height of the retrofit should be approximately one-half the height of structure.

Rt-P

Perforated Half-Round Pipe with Stone Filter

- Drainage area shall not exceed 30 acres.
- Never use on exposed pipe end or winged headwall.
- Diameter of half-round pipe should be 1.5x the diameter of the principal pipe outlet or wider than the greatest width of the concrete weir.

- Shall be affixed by means to the concrete outlet structure.

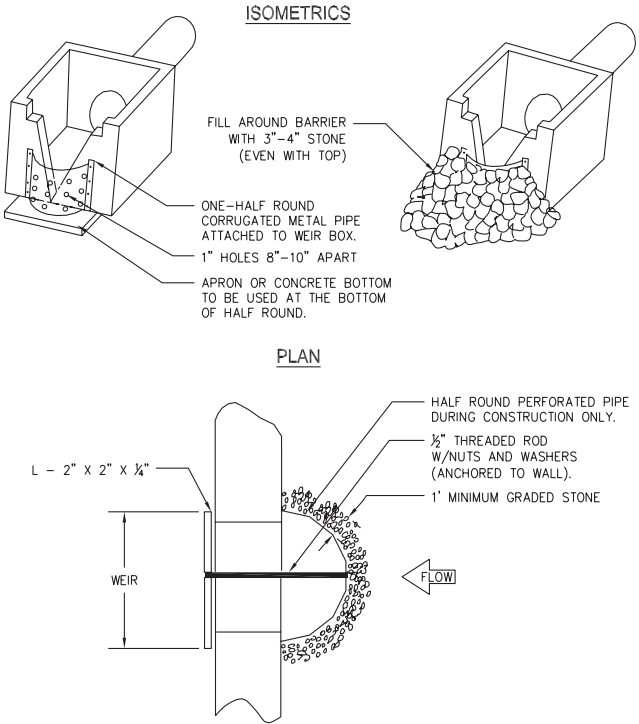

Figure 1. Perforated Half-Round Pipe Retrofit with Stone Filter.



Figure 2. Affixed to Concrete Structure



Figure 3. Slotted Board Dam

Slotted Board Dam with Stone **Rt-B**

- For use in detention ponds with drainage areas up to 100 acres and on roadway drainage structures with a drainage area of 30 acres or less.
- Can be used with open end pipe outlets, winged headwalls, or concrete weir outlets.
- Install with minimum 4x4" posts.
- Install boards with a 0.5"-1.0" space between them.
- Install a minimum of 3"-4" stone or approved filter fabric around the upstream side of the board dam.

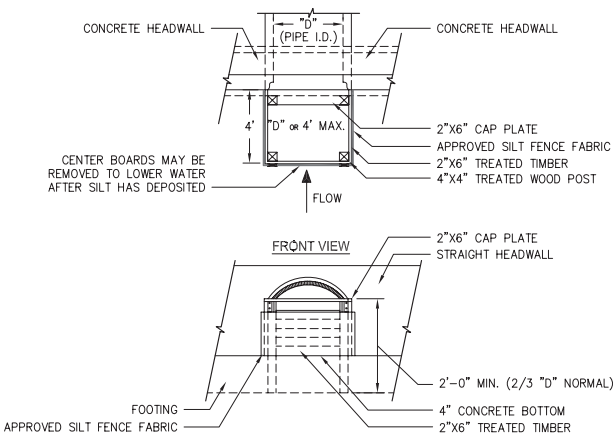

Figure 3. Slotted Board Dam Installation Requirements

Silt Control Gate

Rt-Sg

- Use only on roadway drainage structures with the following structures: winged headwalls, tapered headwalls, straight headwalls, open end pipes, flared end sections.
- Drainage area shall not exceed 50 acres and the disturbed area of the basin shall not exceed 5 acres.
- Use 4"x4" treated posts & 2"x6" treated face boards with no spacing between the boards.
- Fasten an approved silt fence fabric to the front of the structure with staples or nails.

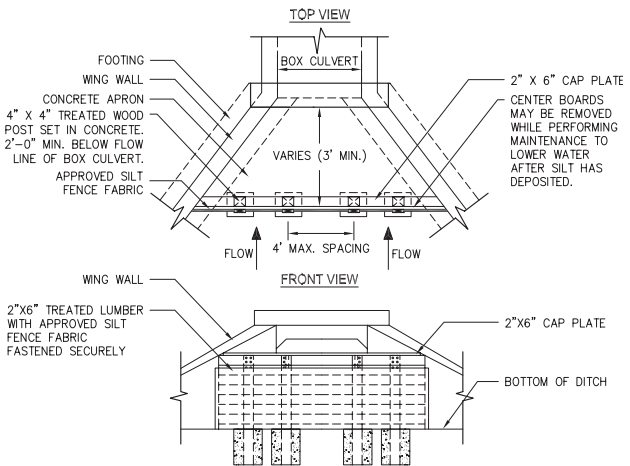

Figure 3. Silt Control Gate Installation Requirements

MAINTENANCE

- Clean-out when one-third sediment storage capacity is lost. Indicate this elevation with a mark on the outlet structure or a post inserted in the pond.
- Remove all trash and debris.
- Remove retrofit and accumulated sediment when the project is completed.
- Stabilize all disturbed areas immediately with permanent vegetation.

Sd1

SEDIMENT BARRIER

DEFINITION

A temporary structure made up of porous material typically supported by steel or wood posts. Types include silt fence, brush piles, mulch berms, compost filter socks or other filtering material.



PURPOSE

- Minimize and prevent sediment carried by sheet flow from leaving the site.
- Retain the sediment on the disturbed area.
- Filter sediment from runoff.

INSTALLATION

- Install according to the approved plan.
- Do not install across streams, ditches, waterways, or other concentrated flow areas.
- The type of sediment barrier depends on whether the area is sensitive or non-sensitive.
- For silt fence, Type C will be classified as sensitive and Type A & B will be classified as non-sensitive.
- Install along the contour.
- Along all state waters and other sensitive areas, 2 rows of Type S shall be used. The 2 rows shall be placed a minimum of 36" apart.

- Overlap barriers 18” when using multiple types of sediment barriers in a single run on a site.
- When storing runoff behind the sediment barrier, the maximum continuous slope length behind the sediment barrier shall not exceed those found in Table 1.
- Provide a riprap splash pad or other protection device at any point where flow may overtop the sediment barrier.

Installation Methods

Static Slicing Method

- Using a machine, pull a narrow blade through the ground to create a 12” deep slit, and simultaneously insert the silt fence fabric into the slit behind the blade.
- Roll a tractor wheel along both sides of the slit in the ground 2-4 times to achieve compaction
- Drive posts 18” into ground and attach fabric.



Figure 1. Static Slicing Machine

Trenching Method

- Dig a 2”-6” wide trench with a 6” excavation.
- Drive posts 18” into ground and attach fabric.
- The best trenching method typically requires triple the time and effort to achieve results comparable to the static slicing method.

Sd1

Sensitive Areas

Sd1-S

Sediment barriers being used as Type S shall have a support spacing of no greater than 4 ft on center, with each being driven into the ground a minimum of 18".

Type C Silt Fence

- 36" wide with wire reinforcement or equivalent backing
- To be used where runoff velocities are particularly high or where slopes exceed a vertical height of 10 ft.

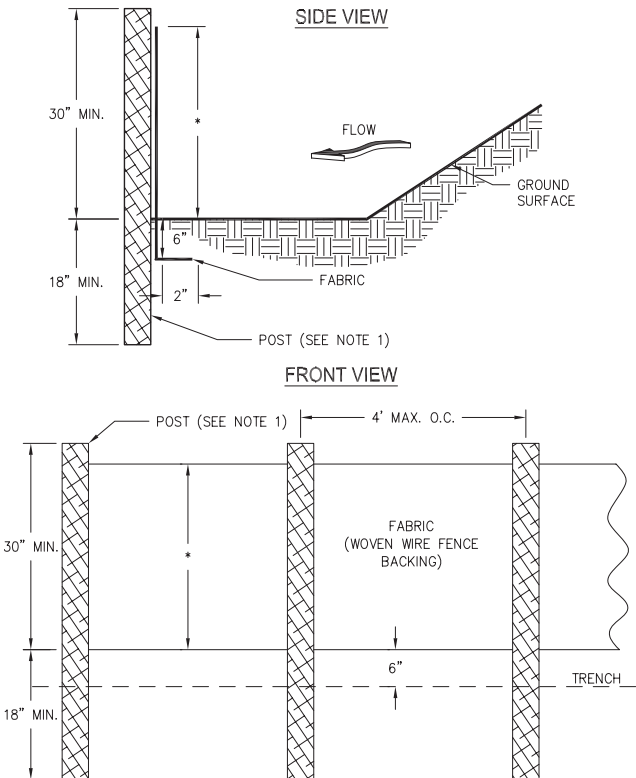

Figure 1. Type "C" Silt Fence

Sd1-NSNon-Sensitive Areas

Sediment barriers being used as Type NS shall have a support spacing of no greater than 6 ft on center, with each being driven into the ground a minimum of 18".

Type A Silt Fence

- 36" wide fabric
- To be used where the life of the project is greater than or equal to 6 months.

Type B Silt Fence

- 22" wide fabric
- Limit to use on minor projects, such as residential home sites or small commercial developments where permanent stabilization will be achieved in less than 6 months.
- Same flow rate as Type A.

BRUSH BARRIER SECTION

Figure 1. Brush Barrier (Sd1-BB)

Brush Barrier (only during timber clearing)

- Intermingle brush so as not to form a solid dam.
- Should be wind-rowed on the contour as nearly as possible.
- Minimum base width is 5 ft and should be no wider than 10 ft.
- The height should be between 3-5 ft.

Sd1

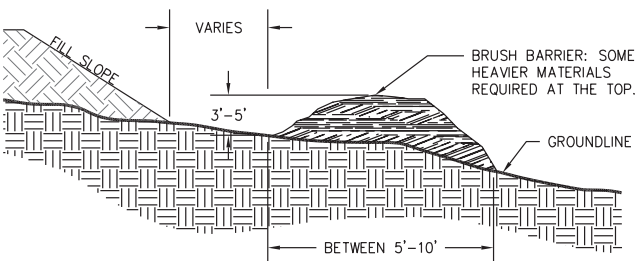
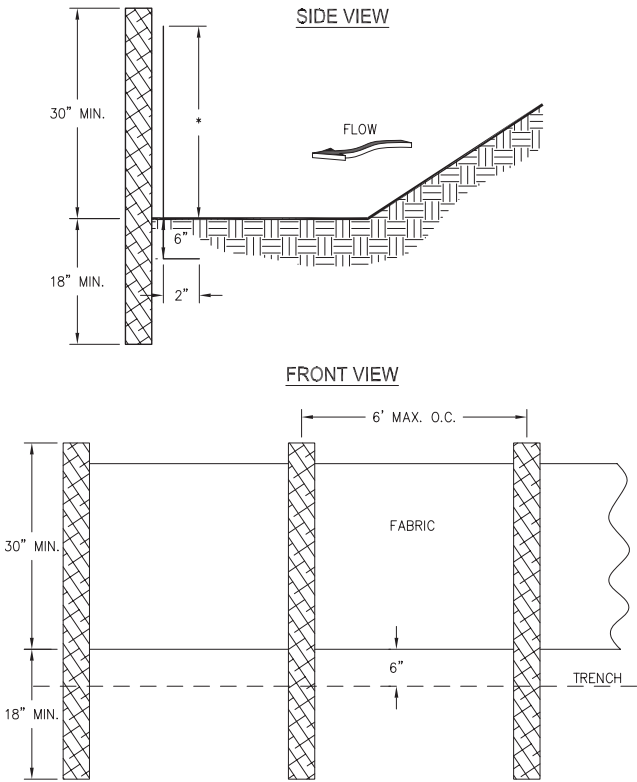

Figure 2. Type "A" & "B" Silt Fence

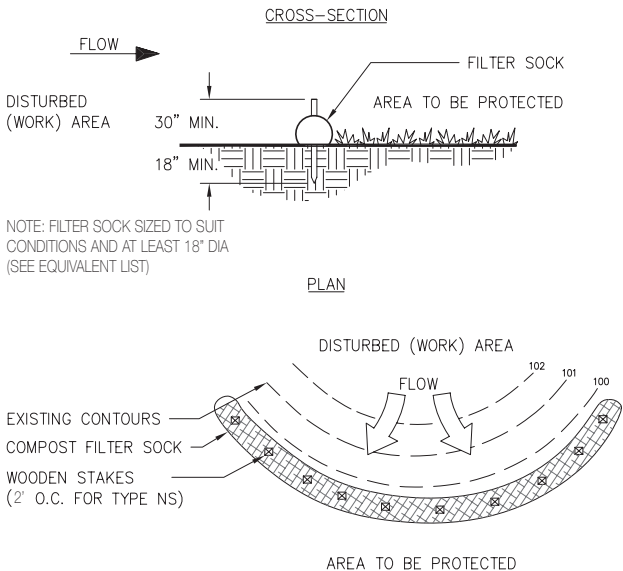

Figure 3. Compost Filter Sock - Type "B"

Table 1. Criteria for Sediment Barrier Placement

| Land Slope (%) | Maximum Slope Length Behind Fence (ft) |
|----------------|--|
| <2 | 100 |
| 2-5 | 75 |
| 5-10 | 50 |
| 10-20 | 25 |
| >20 | 15 |

MAINTENANCE

- Remove the sediment once it has accumulated to one-half the original height of the barrier.
- Replace barrier whenever it has deteriorated to such an extent that the effectiveness of the product is reduced (~ 6 months) or the height of the product is not maintaining 80% of its properly installed height.
- Remove and dispose of all accumulated sediment at the barrier before it is removed.
- Leave in place until all disturbed areas are permanently stabilized.

Table 2. Post Size

| Type | Min. Length | Type of Post | Size of Post |
|------|-------------|---------------------------|---|
| NS | 4' | Oak Steel Soft Wood | 1.5"x1.5" 1.15lb/ft min 3" or 2"x4" |
| S | 4' | Oak Steel | 2"x2" 1.15lb/ft. min |

DEFINITION

A temporary protective device formed at or around an inlet to a storm drain to trap sediment.

**PURPOSE**

- Prevent sediment from entering a storm drainage system prior to permanent stabilization of the disturbed area draining to the inlet.

INSTALLATION

- Install according to the approved plan.
- Do not install on paved surfaces where safety is a concern.
- Sediment traps must be self-draining unless otherwise protected.
- Install at or around all storm drain drop inlets that receive runoff from disturbed areas.
- Construct on natural ground surface, excavated surface, or on machine compacted fill.

Excavated Sediment Traps

- An excavation created around the inlet to provide additional sediment storage.
- Provide a minimum depth of 1.5 ft for sediment storage.
- The side slopes shall not be steeper than 2:1.
- The drainage area entering the trap shall be no greater than 1 acre.

Sd2

Sd2-F

Filter Fabric with Supporting Frame

- Applicable where the inlet drains a relatively flat area (<5% slope).
- Use Type S steel posts.
- Space stakes evenly around perimeter at a maximum of 3 ft apart.
- Drive stakes into the ground ~18" deep.
- The fabric shall be 36" tall and entrenched at least 12" and backfill with crushed stone or compacted soil.
- Securely fasten the fabric and wire to the posts.

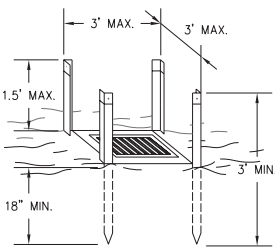

NOTES:

1. DESIGN IS FOR SLOPES NO GREATER THAN 5% (NOT DESIGNED FOR CONCENTRATED FLOWS).
2. THE STEEL POSTS SUPPORTING THE SILT FENCE MATERIAL SHOULD BE SPACED EVENLY AROUND THE PERIMETER OF THE INLET (MAXIMUM OF 3' APART).
3. THE STEEL POSTS SHOULD BE SECURELY DRIVEN AT LEAST 18" DEEP.
4. THE FABRIC SHOULD BE ENTRENCHED AT LEAST 12" AND THEN BACKFILLED WITH CRUSHED STONE OR COMPACTED SOIL.

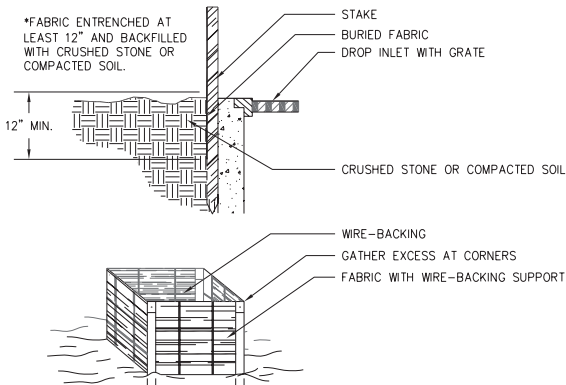

Figure 1. Filter Fabric with Supporting Frame Installation Requirements (Sd2-F)

Sd2-Bg

Block and Gravel Drop Inlet Protection

- Applicable where heavy flows are expected and a overflow capacity is necessary to prevent excessive ponding.

Sd2

- Excavate foundation at least 2" below the crest of the storm drain.
- On each side of the structure, place one block in the bottom row on its side to allow pool drainage.
- Place the bottom row of blocks against the edge of the storm drain.
- Add support by placing 2"x4" wood studs through block openings.
- Fit hardware cloth or wire mesh with 1/2" openings over all block openings to hold gravel in place.
- Place clean gravel 2" below the top of the block on a 2:1 or flatter slope and smooth it to an even grade.
- GADOT #57 stone is recommended.

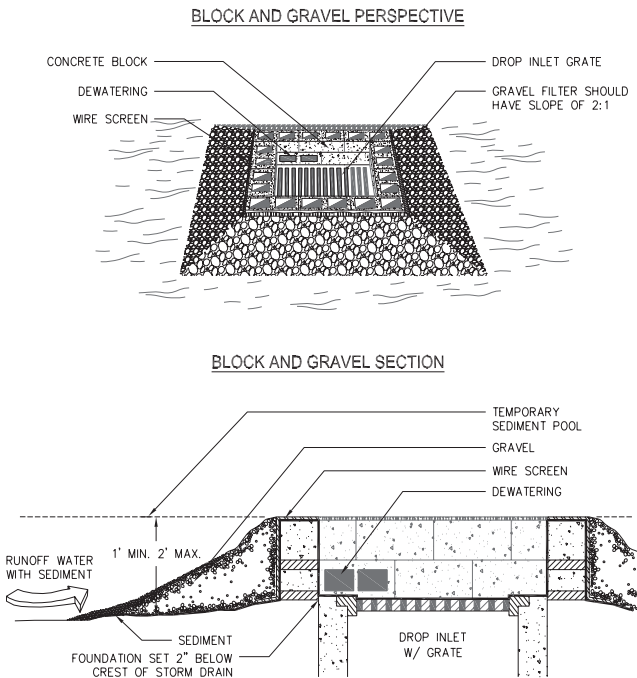

Figure 2. Block and Gravel Drop Inlet Protection Installation Requirements (Sd2-Bg)

Sd2-B**Baffle Box**

- Applicable for inlets receiving a higher volume or velocity.
- Construct 2"x4" boards spaced a maximum of 1" apart OR of plywood with weep holes 2" in diameter.
- Place weep holes ~6" on center vertically or horizontally.
- Place gravel outside of the box and around the inlet at a depth of 2-4".
- Wrap entire box in Type C filter fabric and entrench at a depth of 12".

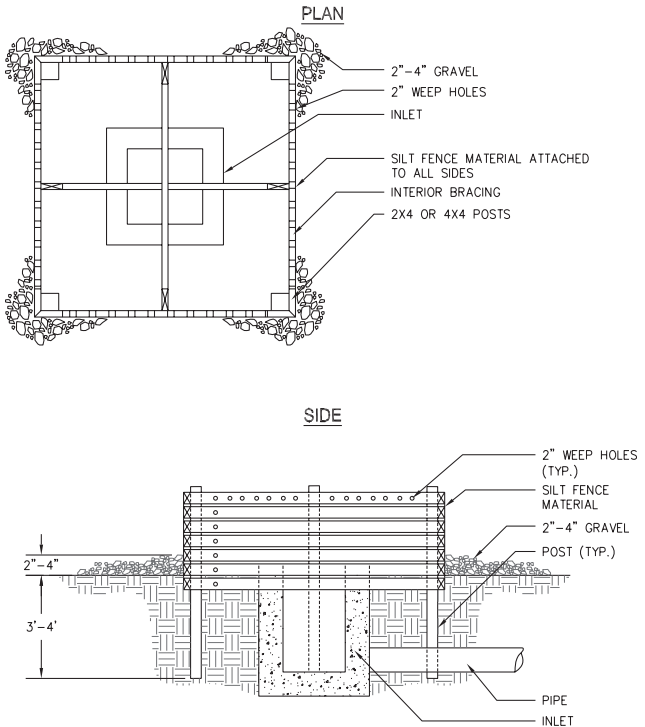

Figure 3. Baffle Box Installation Requirements (Sd2-B)

Gravel Drop Inlet Protection**Sd2-G**

- Applicable where heavy concentrated flows are expected.
- 3:1 or flatter slope toward the inlet.

Sd2

- Leave a minimum 1 ft wide level stone area between the structure and the inlet to prevent gravel from entering the inlet.
- Place stone 3" in diameter or larger on the slope toward the inlet.
- Place 1/2" to 3/4" gravel on the slope away from the inlet at a minimum thickness of 1 foot.

Sd2-S

Sod Inlet Protection

- Applicable only at the time of permanent seeding in order to protect the inlet from sediment and mulch material.
- Place the sod to form a turf mat covering the soil for a distance of 4 ft from each side of the inlet.
- Stagger sod strips so that adjacent ends are not aligned.

SOD STRIPS PROTECT INLET AREA FROM EROSION
(SOURCE: VA SWCC)

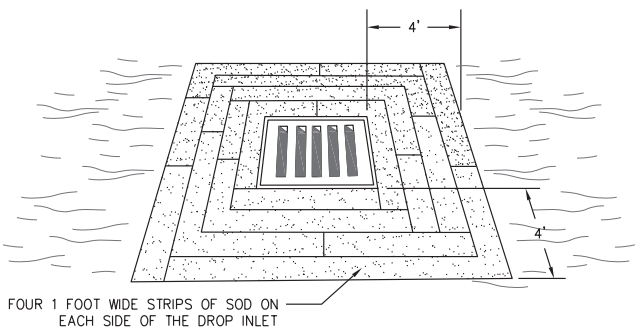

Figure 4. Sod Inlet Protection Installation Requirements (Sd2-S)

Curb Inlet Protection

Sd2-P

- Applicable once pavement has been installed.
- The method of inlet protection shall be removed if a safety hazard is created.

- For the “pigs-in-a-blanket” method, wrap 8” concrete blocks in filter fabric and span across catch basin inlet.
- Face openings in blocks outward.
- Leave a gap of ~4” between the inlet filter and the inlet to allow for overflow and prevent hazardous ponding in the roadway.
- Another method uses gravel bags constructed by wrapping GADOT #57 stone with filter fabric, wire, plastic mesh, or equivalent material.

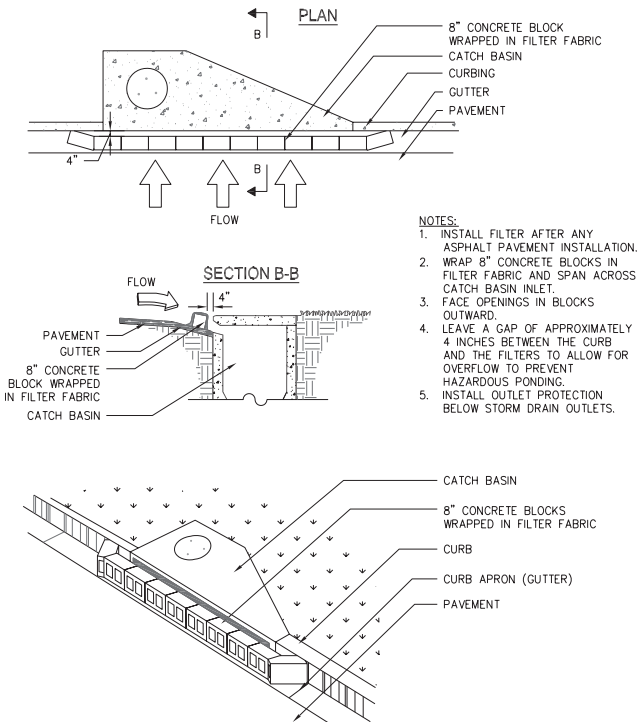

Figure 5. Curb Inlet Protection Installation Requirements (Sd2-P)

Sd2

MAINTENANCE

- Inspect, clear, and/or repair trap at the end of each working day.
- Do not remove inlet protection and wash sediment into the inlet.
- Remove sediment when accumulation has reached one-half the height of the trap.
- Remove sediment from curb inlet protection immediately.
- Remove all materials and any sediment once the contributing drainage area has been permanently stabilized.
- Appropriately stabilize all disturbed areas around the inlet.

REFERENCES

Ds4

Disturbed Area Stabilization
(With Sodding)

Sd1

Sediment Barrier

Sd2

(This page left blank intentionally.)

Sd3

TEMPORARY SEDIMENT BASIN

DEFINITION

A basin created by the construction of a barrier or dam across a concentrated flow area, or by excavating a basin, or by a combination of both.



PURPOSE

- Detain runoff waters and trap sediment from erodible areas.
- Protect properties and drainage ways below the installation from damage by excessive sedimentation and debris.

INSTALLATION

- Construct all basins according to the approved plan unless modified by the design professional.
- Remove all trees, vegetation, roots, and other objectionable material.

Location

- Never place basin in a live stream.
- Storm drains should discharge into the basin.
- Install on sites where (1) failure will not result in loss of life or interruption of use or service of public utilities and (2) the drainage area does not exceed 150 acres.

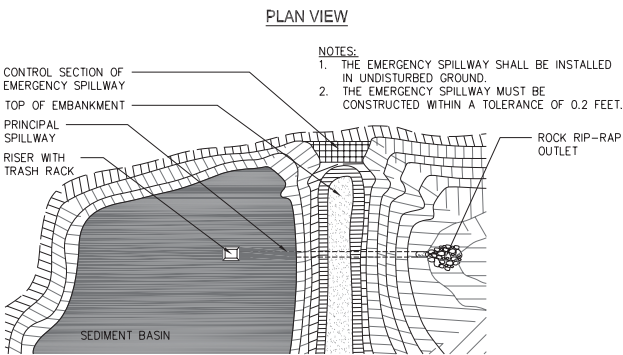
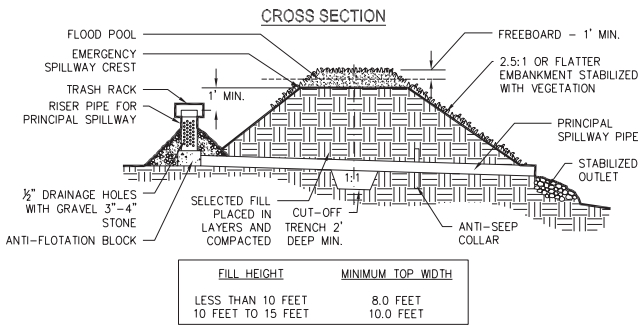

Figure 1. Components of a Typical Temporary Sediment Basin

Shape

- Length to width ratio shall be greater than 2:1
- The basin should be wedge shaped with the inlet at the narrow end.
- Install baffles and diversions when necessary.

Principal Spillway

- Join vertical pipe or box type riser to a pipe that extends through the embankment and exits beyond the downstream toe of the fill.
- The crest elevation of the riser should be 1 ft below the elevation of the control section of the emergency spillway.
- The riser and all pipe connections shall be completely watertight.
- Install pipe with a minimum diameter of 8".

Sd3

- If using the conventional method for dewatering a sediment basin, Perforate lower half of riser with 1/2" holes spaced approximately 3", and cover with 2 ft of 3"-4" stone.
- If constructing the basin with a skimmer outlet, please refer to the specification **Sk - Floating Surface Skimmer**.
- Install a trash rack and anti-vortex device securely on top of the riser.
- Attach riser to the base with a watertight connection. Embed riser 9" into an 18" thick concrete base.
- Provide an adequate outlet that allows discharge in an erosion free manner.
- Place the fill material around the the pipe spillway in 4" layers and compact to at least the same density as the adjacent embankment.
- A minimum depth of 2 ft of hand compacted backfil shall be placed over the pipe spillway before crossing it with construction equipment.

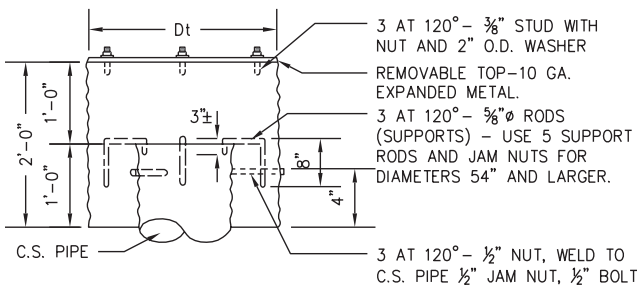

Figure 2. Typical Sediment Basin Trash Rack

Emergency Spillway

- Construct on undisturbed ground (not fill).
- Excavate a trapezoidal channel with minimum bottom width of 8 ft.

CONCRETE RISER BASE DETAIL

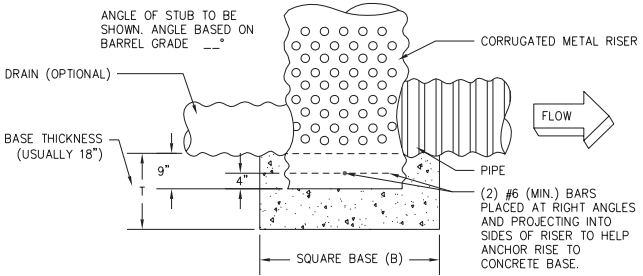
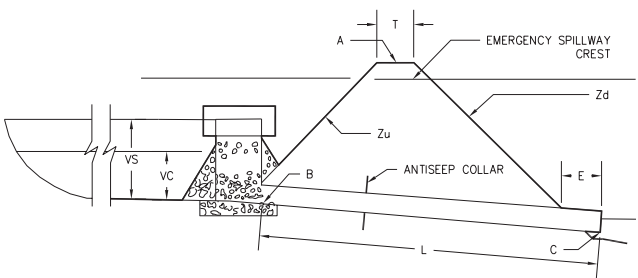

Figure 3. Concrete Riser Base Detail

- Construct a channel with a straight control section of at least 20 ft in length and a straight outlet section that is at least 25 ft in length.
- Stabilize with vegetation, asphalt, riprap or concrete.

Entrance of Runoff into Basin

- Install dikes, swales, or other water control devices to direct runoff into the basin.
- Locate points of entry as far away from the riser as possible.



- A = TOP OF DAM ELEVATION
- B = LOWEST ELEVATION OF PIPE AT RISER
- C = LOWEST ELEVATION OF PIPE AT OUTLET
- E = EXTENDED LENGTH OF PIPE BEYOND TOE OF DAM
- L = TOTAL LENGTH OF PIPE, FT.
- $L = [A - (B + C) / 2] [Z_u + Z_d] + T + E$
- T = TOP WIDTH OF DAM, FT.
- Z_u = UPSTREAM SIDE SLOPE
- Z_d = DOWNSTREAM SIDE SLOPE

Figure 4. Principle Spillway

Sd3

- Stabilize the embankment and all other disturbed areas in accordance with the appropriate permanent vegetative measure, Ds3, immediately following construction.



Figure 5. Clean-out marker

Cut-off Trench

- Excavate a cut-off trench with a minimum depth of 2 ft along the center-line of the earth-fill embankment.
- Extend both abutments up to the riser crest with a minimum bottom width of 4 ft in order to permit operation of compaction equipment.
- Side slopes shall be no steeper than 1:1

Embankment

- Place fill material in 6"-8" thick continuous layers over entire length of fill.
- Construct the embankment to an elevation 5% higher than the design height to allow for settlement.
- Fill material shall be free of rocks, woody vegetation, oversized stones, rocks, etc.

Table 1. Dam Width Requirements

| Fill Height (ft) | Minimum Top Width (ft) |
|------------------|------------------------|
| <10 | 8 |
| 10-15 | 10 |

MAINTENANCE

- Repair all damages caused by soil erosion or construction equipment at or before the end of each working day.
- Remove sediment from the basin when one-third of the storage volume has been lost to accumulation.
- Do not allow sediment to enter adjacent streams or drainage ways during the sediment removal process.
- Do not deposit sediment downstream from the embankment, adjacent to a stream or floodplain.
- Dispose of all temporary structures when they have served their intended purpose and the contributing drainage basin has been properly stabilized.

REFERENCES

Ds1Disturbed Area Stabilization
(With Mulching Only)**Ds2**Disturbed Area Stabilization
(With Temporary Seeding)**Ds3**Disturbed Area Stabilization
(With Permanent Vegetation)**Ds4**Disturbed Area Stabilization
(With Sodding)**Ch**

Channel Stabilization

Sk

Floating Surface Skimmer

St

Storm Drain Outlet Protection

Sd4

TEMPORARY SEDIMENT TRAP

DEFINITION

A small temporary pond that drains a disturbed area so that sediment can settle out.



PURPOSE

- Collect and store sediment from uphill sites cleared and/or graded during construction.
- For use on small tributary areas with no unusual drainage features.

INSTALLATION

- Install according to the approved plan.
- Sediment traps are effective against coarse sediment, but not against silt or clay particles.
- The maximum drainage area is 5 acres depending on the type of installation.
- The maximum depth of a trap is 4 ft as measured from the bottom of the trap to the invert of the emergency spillway.
- Ensure the length to width ratio is great than 2:1.
- The height of the embankment shall not exceed 5.5 ft from the downstream toe to the top of the berm. The top width shall be at least 3 ft.
- Slopes shall not exceed 2:1.

Sd4

- Construct side slopes 3:1 or flatter to allow people and equipment to enter the trap.

Methods

Overflow Outlet

Sd4-A

- Limited to small drainage areas less than 1 acre with gentle slopes(1-2%).
- The maximum life span is 6 months.
- Silt fence, straw bale barriers or grass filter strips are used to “polish” the overflow water as it leaves the sediment trap.

Combination Outlet

Sd4-B

- A combination of straw bales and silt fence are used to dewater the trap.
- Properly install and stake the straw bales and ensure the silt fence has a wire backing so that the materials can resist 1 ft or more of ponded water.
- The maximum drainage area is 1 acre.
- The life span is less than 1 year.
- Requires frequent maintenance and adjustments.

Rock Outlet

Sd4-C

- This type relies on filtering through layers of aggregate, rock or riprap material to dewater the sediment trap.
- This is the sturdiest design of the three and requires less maintenance.
- The maximum drainage area is 5 acres.
- The life span is typically 1 year.

Sd4

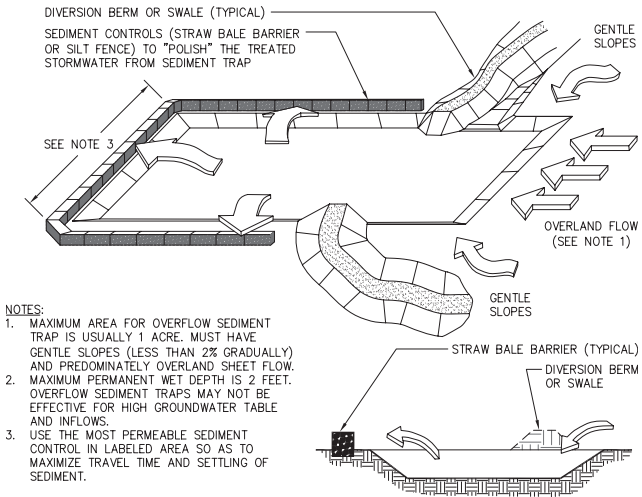

Figure 1. Overflow Outlet

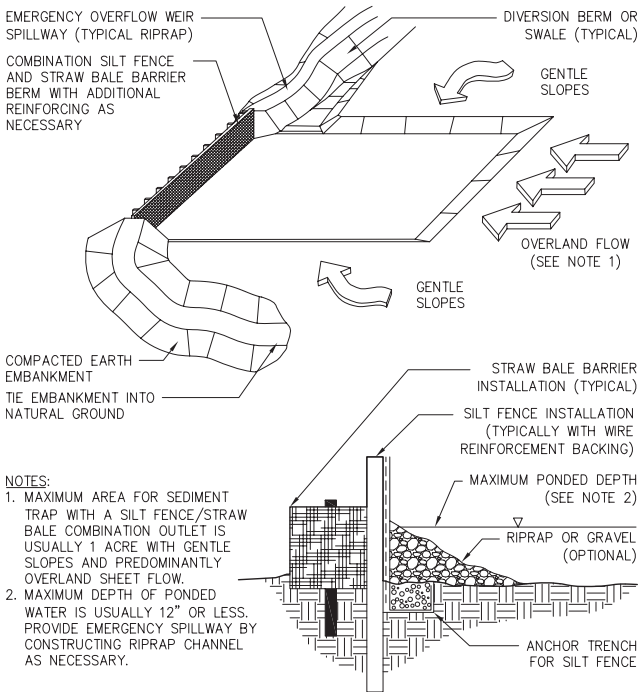

Figure 2. Combination Outlet

Emergency Spillway

- Stabilize with rock, geotextile, vegetation, or another suitable material that is resistant to erosion.
- Must be able to convey the 10-year storm event.

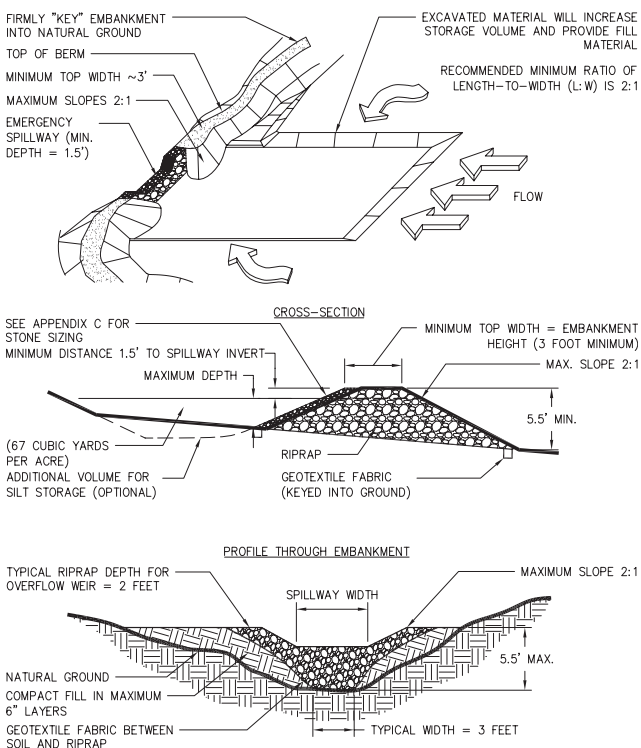

Figure 3. Rock Outlet

MAINTENANCE

- Repair all damages caused by soil erosion or construction equipment at or before the end of each working day.
- The cleanout volume for a temporary sediment trap is one-third of the total storage volume.



FLOATING SURFACE SKIMMER

DEFINITION

A buoyant device that releases/drains water from the surface of sediment ponds, traps, or basins at a controlled rate of flow.

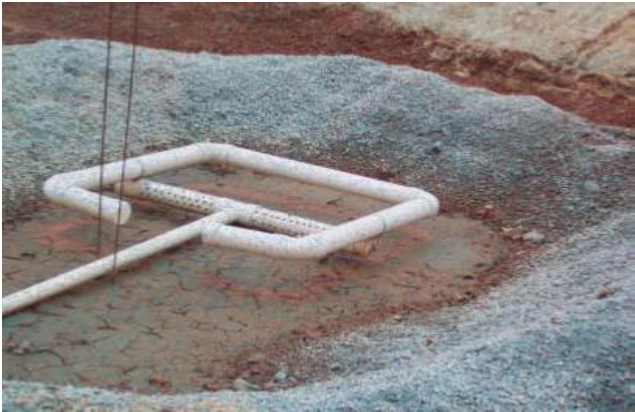

PURPOSE

- Discharge clearer water from the surface of a sediment pond, trap, or basin at relatively uniform rate.
- Reduce the retention time associated with meeting a desired water quality standard for discharge from a sediment pond, trap or basin.

INSTALLATION

- Install according to the approved plan.
- It can replace the riser pipe as the principal spillway, but does **not** replace the emergency spillway.
- A portion of the skimmer must be visible above the water surface at all times.
- Excavate a pit filled with riprap under the floating surface skimmer to account for sediment accumulation around the device.
- At a minimum, the pit has dimensions of 4x4 ft with a minimum depth of 2 ft.

- Ensure the pit is lower than the invert of the outlet barrel from the riser.
- Use floating surface skimmers constructed of PVC (Schedule 40 or greater) or other appropriate materials.
- Install the device according to the approved plan and manufacturer's instructions.

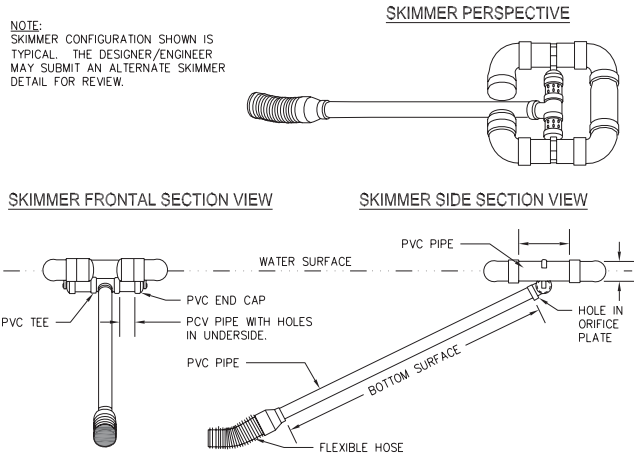

Figure 1. “Typical” Skimmer Design

MAINTENANCE

- Inspect Floating Surface Skimmers together with the Sediment Basin (Sd3) inspections.
- Inspect for any structural damage, clogging, or excessive sediment accumulation.
- Install trash guard to prevent larger debris from entering the skimmer and cause internal blocking.
- Use a floatable maintenance rope to remove trash and debris that accumulates on the outside of the trash guard.
- Free the skimmer from being stuck in the mud at the bottom of the basin to allow for normal operation.

DEFINITION

A linear control device constructed as a diversion perpendicular to the direction of runoff to enhance dissipation and infiltration, while creating multiple sedimentation chambers with the employment of intermediate dikes.

**PURPOSE**

- Allows the 2 year, 24-hour storm to seep out while allowing larger flows to be diverted to a sediment storage area.

INSTALLATION

- Install according to the approved plan.
- Install where runoff can be stored behind the seep berm without damaging the berm or submerged area behind the intermediate dike points.
- Do not use above fill slopes that have not achieved permanent stabilization.
- Do not install across streams, ditches, or waterways.
- The top of the berm shall have a minimum width of 12" and a height of 4 ft.

- Maximum spacing between the dikes should be such that the toe of the upstream dike is at the same elevation as the top of the downstream dike.
- Install clean out markers at each intermediate dike using a sediment storage calculation.
- Compact the earthen berm by using a skid-loader with a full bucket, tracking with a dozer and applying pressure with the bucket, or rubber tired backhoe.
- Compaction must meet a minimum of 90% standard proctor density test.
- Apply seed at 70% germination or better prior to other land disturbing activities taking place.

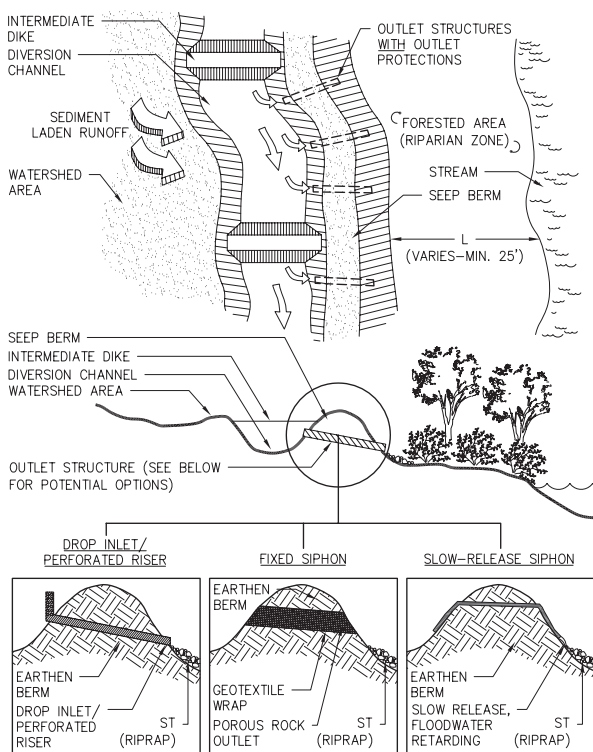

Figure 1. "Typical" Seep Berm System

SpB

- Seeps can be placed 3 different ways:
 - During the construction of the berm,
 - After construction has been completed, excavate at the location of the seeps, place in the trench and back-fill. Compact the berm to finalize,
 - After construction has been completed, using a steel pipe with a conical end, insert pipes through the berm.

MAINTENANCE

- Inspect the dam from the seep and supporting berm after every 1/2" or greater rainfall.
- Make any repairs promptly.
- Remove sediment when it has accumulated to one-third the height of the intermediate dike.

SpB

(This page left blank intentionally.)

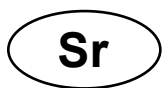

TEMPORARY STREAM CROSSING

DEFINITION

A temporary structure installed across a flowing stream or watercourse for use by construction equipment.



PURPOSE

- Provide a means for construction vehicles to cross streams or watercourses without moving sediment into streams, damaging the streambed or channel, or causing flooding.

INSTALLATION

- Install according to the approved plan.
- The drainage area is not to exceed one square mile, unless specifically designed to accommodate the additional drainage area by the design professional.
- Structures include bridges, round pipes, or pipe arches.
- Do not allow for use by the general public.
- Install perpendicular to the stream. The crossing may vary 15° from the perpendicular.
- Divert all surface water from the construction site onto undisturbed areas adjoining the stream.

- Convey full bank flow of stream without appreciably altering the stream flow characteristics.
- Washout protection may include elevation of bridges above adjacent flood plain lands, crowning of fills over pipes, or the use of diversions, dikes or island type structures.
- A Stream Buffer Variance from the GA EPD may be required and all other appropriate agencies, including the U.S. Army Corps of Engineers, must be contacted to ensure compliance with other laws.

Types of Stream Crossings

Temporary Bridge Crossing

Sr-B

- This method causes the least amount of erosion of the stream channel.
- Provides the least obstruction to flow and fish migration.
- Construct at or above the bank elevation to prevent entrapment of floating materials.
- Place abutments parallel to and on stable banks.
- Construct the bridge to span the entire channel. Install a footing, pier, or bridge support if the span exceeds 8 ft.
- Securely anchor the bridge at one end with a steel cable or chain, large trees, large boulders, or driven steel anchors.

Temporary Culvert Crossing

Sr-C

- The most common stream crossing design.
- Can be easily constructed and enables heavy equipment loads to be used.
- Creates the greatest obstruction to stream flows and are subject to blockages.

Sr

- Install the invert elevation of the culvert on the natural streambed grade.
- Extend the culvert(s) a minimum of 1 ft beyond the upstream and downstream toe of the aggregate placed around the culvert.
- Do not exceed 40 ft in length of the culvert.
- Cover the culvert(s) with a minimum of 1 ft of aggregate.
- If using multiple culverts, separate them with compacted aggregate fill by a minimum of 12 in.

Table 1. Pipe Diameters for Stream Crossings
(in)

| Drainage | | Average Slope of Watershed | | | |
|--------------|----|----------------------------|----|----|-----|
| | | 1% | 4% | 8% | 16% |
| Acres | | | | | |
| 1-25 | 24 | 24 | 30 | 30 | |
| 26-50 | 24 | 30 | 36 | 36 | |
| 51-100 | 30 | 36 | 42 | 48 | |
| 101-150 | 30 | 42 | 48 | 48 | |
| 151-200 | 36 | 42 | 48 | 54 | |
| 201-250 | 36 | 48 | 54 | 54 | |
| 251-300 | 36 | 48 | 54 | 60 | |
| 301-350 | 42 | 48 | 60 | 60 | |
| 351-400 | 42 | 54 | 60 | 60 | |
| 401-450 | 42 | 54 | 60 | 72 | |
| 451-500 | 42 | 54 | 60 | 72 | |
| 501-550 | 48 | 60 | 60 | 72 | |
| 551-600 | 48 | 60 | 60 | 72 | |
| 601-640 | 48 | 60 | 72 | 72 | |

MAINTENANCE

- Inspect structure after every rainfall and at least once a week.
- Repair all damages immediately.
- Remove the structure immediately after construction is finished.
- Stabilize the streambed and banks.

REFERENCES

- | | |
|------------|---|
| Ds1 | Disturbed Area Stabilization (With Mulching Only) |
| Ds2 | Disturbed Area Stabilization (With Temporary Seeding) |
| Ds3 | Disturbed Area Stabilization (With Permanent Vegetation) |
| Ds4 | Disturbed Area Stabilization (With Sodding) |
| Bf | Buffer Zone |

St

STORM DRAIN OUTLET PROTECTION

DEFINITION

Paved and/or riprapped channel sections placed below storm drain outlets.



PURPOSE

- Reduce the velocity of flow before entering receiving channels below storm drain outlets.

INSTALLATION

- Install according to the approved plan.
- The apron may be lined with riprap, grouted riprap, or concrete.
- Compact any fill required in the subgrade to the density of the surrounding undisturbed material.
- Ensure that the riprap and gravel filter conform to the specified grading limits on the plan.
- Install geotextile between the riprap and the soil base.
- Protect the geotextile from punching or tears during installation. Overlap connecting joints a minimum of 1 ft.
- The minimum thickness of the riprap should be 1.5x the maximum stone diameter.
- Place riprap by hand or equipment. Be careful to avoid damaging the filter fabric.

PIPE OUTLET TO WELL DEFINED CHANNEL

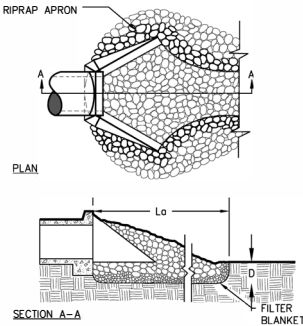

NOTES:

1. L_o IS THE LENGTH OF THE RIPRAP APRON.
2. $D = 1.5$ TIMES THE MAXIMUM STONE DIAMETER BUT NOT LESS THAN 6".
3. IN A WELL-DEFINED CHANNEL, EXTEND THE APRON UP THE CHANNEL BANKS TO AN ELEVATION OF 6" ABOVE THE MAXIMUM TAILWATER DEPTH OR TO THE TOP OF THE BANK (WHICHEVER IS LESS).
4. A FILTER BLANKET OR FILTER FABRIC SHOULD BE INSTALLED BETWEEN THE RIPRAP AND THE SOIL FOUNDATION.

Figure 1. Outlet Protection for a Well-Defined Channel

- Construct the apron on zero grade with no overfall at the end. Ensure the top of the riprap at the downstream end is level with the receiving area or slightly below it.
- Place any necessary curves in the upper section of the apron.
- Ensure the apron is properly aligned and preferably straight throughout its length.
- Stabilize all disturbed areas after construction.

Apron Width for a Well-Defined Channel

- Side slopes of the channel shall be no steeper than 2:1.
- Extend the apron across the channel bottom.
- Extend the apron up the channel banks to an elevation one foot above the maximum tailwater depth or to the top of the bank (whichever is less).

Apron Width for a Flat Area

- The upstream end of the apron shall have a width 3x the diameter of the outlet pipe.
- For a Minimum Tailwater Condition, the downstream end of the apron shall have a width equal to the pipe diameter plus the length of the apron.

St

- For a Maximum Tailwater Condition, the downstream end shall have a width equal to the pipe diameter plus 0.4x the length of the apron.

PIPE OUTLET TO FLAT AREA -- NO WELL DEFINED CHANNEL

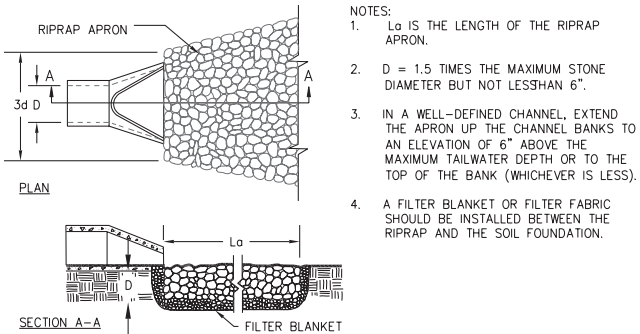

Figure 2. Outlet Protection for a Flat Area

MAINTENANCE

- Inspect riprap outlet structures after heavy rain events to see if any erosion has taken place around or below the riprap.
- Make all needed repairs immediately to prevent further damage.

St

(This page left blank intentionally.)

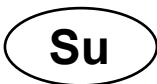

SURFACE ROUGHENING

DEFINITION

Providing a rough soil surface with horizontal depressions created by operating a tillage or other suitable implement on the contour.



PURPOSE

- Aid in the establishment of vegetative cover with seed.
- Reduce runoff velocity and increase infiltration.
- Reduce erosion and provide for sediment trapping.

INSTALLATION

- Conduct according to the approved plan.
- Required on all slopes steeper than 3:1 if they are to be stabilized with vegetation.
- If slope is to be stabilized with matting and blankets, the surface should not be roughened.
- Not required on slopes with a stable rock face.
- Lightly roughen and loosen soil to a depth of 2"-4" on slopes 3:1 or flatter.
- Areas that will be mowed should have slopes less than 3:1.
- Groove or maintain roughness of fill slopes steeper than 3:1.

- Stair-step grade or groove cut slopes steeper than 3:1.

Roughening Methods

Stair-Step Grading

- May be carried out on any material soft enough to be ripped with a bulldozer.
- Particularly good for slopes with soft rock and some subsoil.
- The ratio of the vertical cut distance to the horizontal distance shall be less than 1:1.
- Horizontal portion of the “step” shall slope toward the vertical wall.

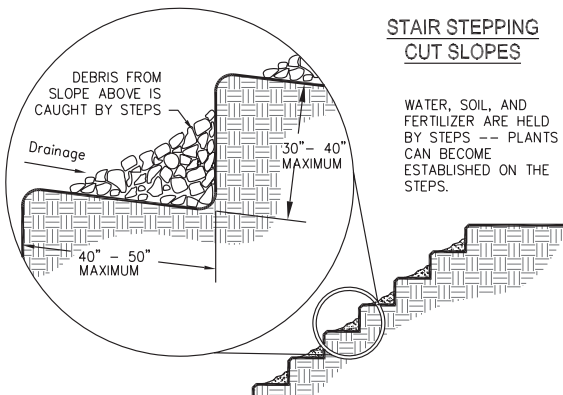

Figure 1. Stair-Stepping Cut Slopes

- Individual vertical cuts are not to exceed 30” on soft materials and not more than 40” in rocky materials.

Grooving

- Use discs, tillers, spring harrows, or the teeth on a front-end loader.
- On un-mowed slopes, minimum groove depth of 3” and maximum groove spacing of 15”.
- On mowed slopes, minimum depth of 1” and maximum groove spacing of 12”.

Su

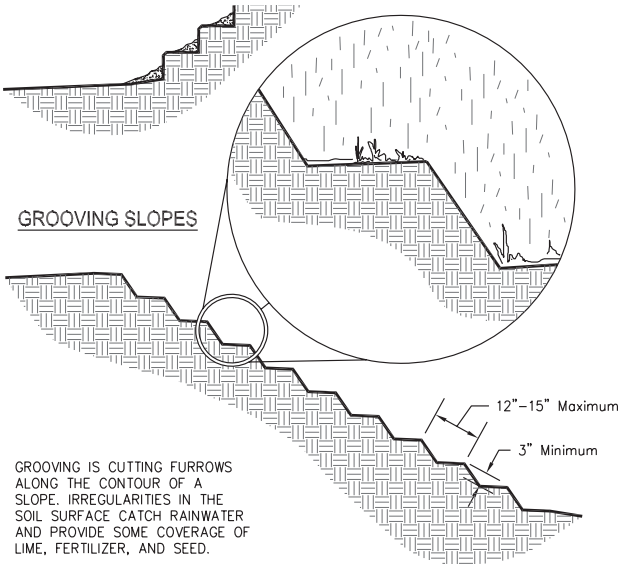

Figure 2. Grooving Slopes

Tracking

- Not recommended on clayed soils unless no alternatives are available.
- Sandy soils may be tracked because they do not compact severely.
- Minimize machine passes to minimize compaction.
- Roughened areas shall be seeded and mulched as soon as possible to obtain optimum seed germination and growth.

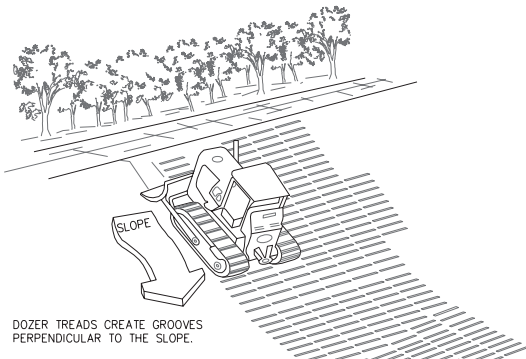

Figure 3. Tracking

FILL SLOPE TREATMENT

EACH LIFT OF THE FILL IS COMPACTED, BUT THE OUTER FACE OF THE SLOPE IS ALLOWED TO REMAIN LOOSE SO THAT THE ROCKS, CLODS, ETC. REACH THE NATURAL ANGLE OF REPOSE.

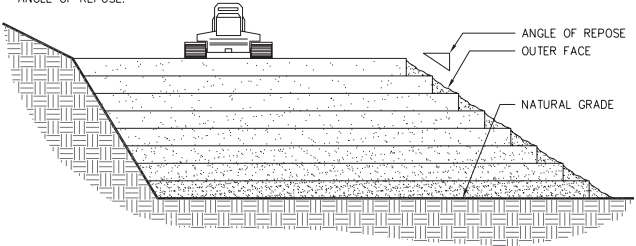
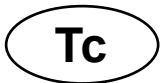

Figure 4. Fill Slope Treatment

REFERENCES

- Ds1** Disturbed Area Stabilization (With Mulching Only)
- Ds2** Disturbed Area Stabilization (With Temporary Seeding)
- Ds3** Disturbed Area Stabilization (With Permanent Vegetation)
- Ds4** Disturbed Area Stabilization (With Sodding)



TURBIDITY CURTAIN

DEFINITION

A floating or staked barrier installed within the water.



PURPOSE

- Minimize turbidity and silt migration from work occurring within the water or as a supplement to perimeter control BMPs at the water's edge.
- Allow suspended particles to drop out of the water column over time.

INSTALLATION

- Install according to the approved plan.
- This practice is only allowed as a primary device when required permitting has been obtained for the site that approves the filling of State or U.S. waters.
- A Stream Buffer Variance from the GA EPD may be required and all other appropriate agencies, including the U.S. Army Corps of Engineers, must be contacted to ensure compliance with other laws.
- Not to be used as sediment storage.

- The installation of a turbidity curtain as a supplemental BMP is allowed provided the stream or other water “body” is not altered in any manner by the installation.
- Place barrier approximately 25 ft outside of the affected construction area for large water bodies.
- Place barrier parallel to flow whenever there is significant velocity or current in the body of water.
- Never allow the silt dispersion to exceed the allowances the filling permit has authorized.
- Installation dimensions and methods shall be fitted to the conditions, permitted activity, and construction methods.

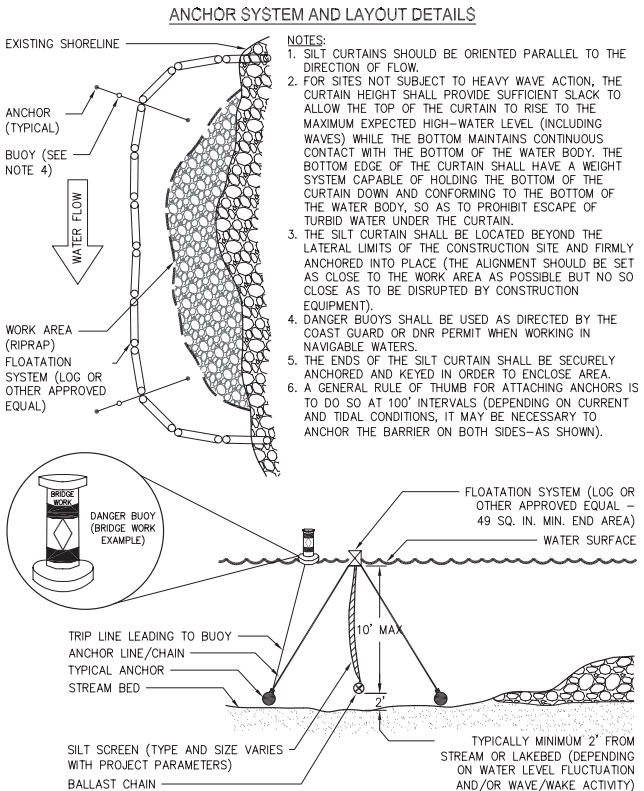

Figure 1. Turbidity Curtain System

Tc

Installation Types

Tc-F

Floating Turbidity Curtain

- Typical installation include large bodies of water such as rivers and lakes.
- Extend curtain to a depth of 5 ft from the bottom of the water body.

Tc-S

Staked Turbidity Curtain

- Typical installations include shallow inundations where construction is required.
- Extend the barrier to the bottom of the streambed.
- Limit the height to 5 ft whenever possible and extend 2 ft above the normal water elevation.

MAINTENANCE

- Remove the curtain when it is no longer required.
- Carefully remove any sediment that exceeds the allowance of the filling permit.
- If using Tc as a supplemental BMP, it should be removed once the contributing drainage area reaches final stabilization and perimeter control removal has occurred.

Tc

(This page left blank intentionally.)

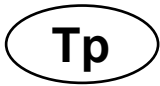

TOPSOILING

DEFINITION

The stripping off of the fertile topsoil, storing it, then spreading it over the disturbed area after the completion of construction activities.



PURPOSE

- Provide a suitable soil medium for vegetative growth on areas where other measures will not produce or maintain a desirable stand.

SPECIFICATIONS

- Recommended for sites with slopes 2:1 or flatter where:
 - (1) the texture of the exposed subsoil or parent material is not suitable to produce adequate vegetative growth.
 - (2) the soil material is so shallow that the rooting zone is not deep enough to support plants with continuing supplies of moisture and food.
 - (3) the soil to be vegetated contains material toxic to plant growth.
- Topsoil should be friable and loamy, free of debris, objectionable weed and stones, and contain no toxic substance that may be harmful to plant growth.

- A stripping depth of 4"-6" is common and should be confined to the immediate construction area.
- Stockpiles should not obstruct natural drainage or cause off-site environmental damage.
- Stockpiles shall be contained by sediment barriers and stabilized with temporary vegetative measures.
- Where the pH of the subsoil is 5.0 or less or composed of heavy clays, agricultural lime shall be spread at a rate of 100lbs/1000 sq.ft.
- Subsoil shall be loosened by discing or scarifying to a minimum depth of 3" to permit bonding of the topsoil to the subsoil. Tracking by a bulldozer is also adequate.
- Topsoil should be applied at a uniform depth of 5" (unsettled), but may be adjusted at the discretion of the design professional.
- Topsoil should be handled only when dry in order to prevent damaging the soil structure.

Table 1. Cubic Yards of Topsoil Required for Application to Various Depths

| Depth (in.) | Per 1,000 Sq. Ft. | Per Acre |
|-------------|-------------------|----------|
| 1 | 3.1 | 134 |
| 2 | 6.2 | 268 |
| 3 | 9.3 | 403 |
| 4 | 12.4 | 537 |
| 5 | 15.5 | 672 |
| 6 | 18.6 | 806 |

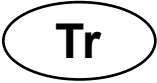

TREE PROTECTION

DEFINITION

The protection of desirable trees from injury during construction activity.



PURPOSE

- Ensure the survival of desirable trees where they will be effective for erosion and sediment control, watershed protection, landscape beautification, dust and pollution control, noise reduction, shade and other environmental benefits while the land is being converted.

SPECIFICATIONS

- Contact the local government to obtain information regarding tree ordinances BEFORE ES&PC plans are designed.

Tree Protection Zones

(1) Measure the diameter of the tree trunk in inches 4.5 ft from the ground. This is the Diameter Breast Height (DBH).

(2) Multiply this value by 1.5. This result is the radius of the root protection zone in ft Also considered the critical rooting distance.

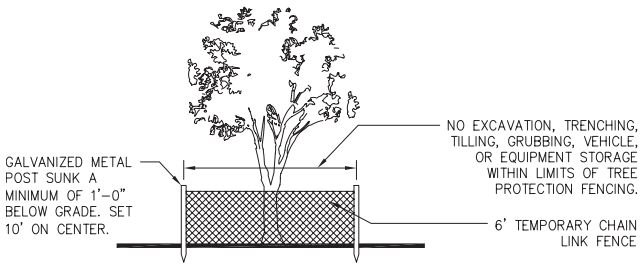

Figure 1. Chain Link Fence Installation

Tree Protection Zone Fencing

Tree protection zone fencing may be one of the following:

- For areas of large remnant forest to be protected, use 4 ft high orange plastic fabric fencing stapled in 3 locations to 2x4 treated wood stakes. Set stakes 6 ft on center. Do not use rebar as stakes.
- For single family homes use a treated wood fencing. It may have orange fabric attached to it.
- For all other developments use 6 ft high chain link fencing attached to galvanized metal post.

*Please refer to the American National Standard(ANSI) or the International Society of Arboriculture for more information regarding standards for adequate tree protection.

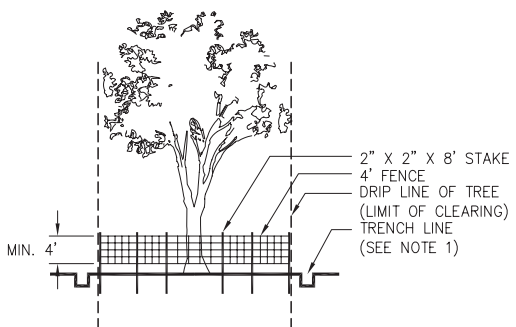

Figure 2. "Snow" Fence Installation

Wt

VEGETATED WATERWAY OR STORMWATER CONVEYANCE CHANNEL

DEFINITION

A natural or constructed channel that is shaped or graded to required dimensions and established in suitable vegetation for the stable conveyance of runoff.



PURPOSE

- Dispose of runoff without causing damage either by erosion or flooding.

INSTALLATION

- Install according to the approved plan.
- Remove all trees, brush, stumps, obstructions and other objectionable material so as not to interfere with the proper functioning of the waterway.
- Ensure the channel is free of bank projections or other irregularities that will impede normal flow.
- Compact fills as needed to prevent unequal settlement.
- Dispose of all excess earth fill so that it will not interfere with waterway functioning.
- Stabilize the channel in accordance with applicable vegetative standards.

- Channel shape may be parabolic, trapezoidal, or triangular.
- The bottom width shall not exceed 50 ft unless multiple or divided waterways or other means are provided to control meandering of low flows within this limit.
- Please refer to Table 1 for design velocities of the grassed waterways.

Table 1. Permissible Velocities for Vegetated and Rock-Lined Waterways

| Vegetative Cover | Maximum Permissible Velocity (fps) |
|--|------------------------------------|
| Bermuda | 5 |
| Bahia | 4 |
| Tall Fescue | 4 |
| Sericea Lespedeza Weeping Lovegrass | 3 |
| Stone Center | Design Required |

- Tile or other subsurface drainage measure shall be provided for sites having high water tables or seepage problems. Where there is base flow, a stone center or lined channel will be required.
- Mulching is required for all seeded or sprigged channels.
- Geotextiles should be used as an erosion control measure beneath the riprap center.
- If conditions permit, water should be temporarily diverted from the channel, or otherwise disposed of, during the establishment of vegetation.

WATERWAY WITH STONE CENTER DRAIN AND
V-SECTION SHAPED BY MOTOR GRADER

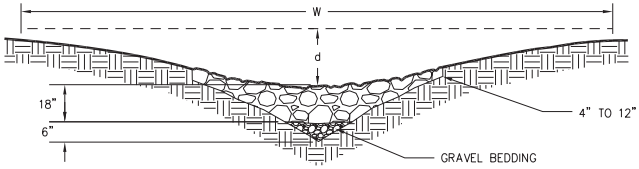

WATERWAY WITH STONE CENTER DRAIN AND
ROUNDED SECTION SHAPED BY BULLDOZER

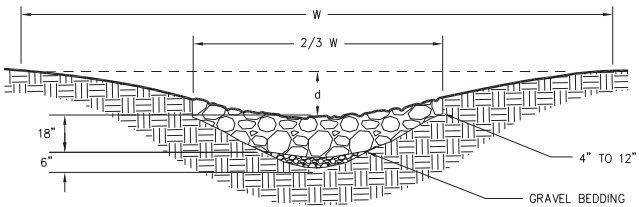

Figure 1. Stone Center Waterway

REFERENCES

- Ds1** Disturbed Area Stabilization
(With Mulching Only)
- Ds2** Disturbed Area Stabilization
(With Temporary Seeding)
- Ds3** Disturbed Area Stabilization
(With Permanent Vegetation)
- Ds4** Disturbed Area Stabilization
(With Sodding)
- Ss** Slope Stabilization

Wt

(This page left blank intentionally.)

O.C.G.A. 12-7-1 The Erosion and Sedimentation Act of 1975 as Amended

HISTORY

The Georgia Erosion and Sedimentation Act was passed in 1975 and became effective in 1977. It has been amended several times; in 1980, 1981, 1982, 1985, 1988, 1989, 1990, 1994, 1995, 2000, 2001, 2003, 2004, 2006, 2007, 2009, 2010, 2012, and 2015. The 1994 and 1995 amendments were significant in that the emphasis was placed on Best Management Practices (BMPs) instead of water quality.

AGENCIES

This law specifically defines the duties of four separate and distinct agencies:

1. Local Issuing Authority (LIA).
2. Department of Natural Resources(DNR) - Environmental Protection Division (EPD)
3. The Soil and Water Conservation Districts (SWCD).
4. The Georgia Soil and Water Conservation Commission (GSWCC).

Unnamed, but critically important to the program, is the Natural Resource Conservation Service (NRCS) of the US Department of Agriculture (USDA).

CERTIFIED LOCAL ISSUING AUTHORITY

A county/city may adopt a local E&S ordinance and become a Local Issuing Authority (LIA). This authorizes the city/county to issue a Land Disturbing Activity (LDA) permit. The responsibilities of a Certified LIA are as follows:

1. Process LDA applications
2. Maintain list of active LDA permits
3. Conduct inspections
4. Enforce ordinance
5. Handle E&S complaints

LAND-DISTURBING ACTIVITIES

The Law defines a land-disturbing activity as:

“Any land change which may result in soil erosion from water or wind and the movement of sediments into State Water or onto lands within the State including, but not limited to clearing, dredging, grading, excavating, transporting, and filling.”

EXEMPTED LAND-DISTURBING ACTIVITIES

The Law contains certain exemptions. Permits for land-disturbing activities are not required for the following:

1. Surface mining.
2. Granite quarrying.
3. Minor land-disturbing activities such as home gardens, home landscaping, etc.
4. Construction of single-family residences if the project disturbs less than 1 acre and is not part of a common development.
5. Agricultural Practices.
6. Forestry Practices.

7. Projects carried out under the technical guidance of the Natural Resources Conservation Service (NRCS).

8. Any project that disturbs less than 1.0 acre unless the activity occurs within 200 ft. of "State Waters" or part of a common plan of development.

9. Road Construction and Utility Projects financed by the Department of Transportation, Georgia Highway Authority or State Road & Tollway Authority. Any road construction or maintenance project undertaken by the city or county is also exempt.

10. Any LDA conducted by an EMC, Public Utilities under PSC Jurisdiction, Municipal Electric Systems, Utilities under FERC jurisdiction, and cable television systems.

11. Public Water System Reservoirs

Even exempted activities must conform to the BMP minimum requirements (O.C.G.A. 12-7-6)

MINIMUM REQUIREMENTS

The minimum requirements specified in the Law mandate that Best Management Practices (BMPs) be designed, installed and maintained in accordance with 16 sound conservation and engineering principals and accommodate up to and including a 25-year, 24-hour rainfall event.

BMPs are vegetative measures and structural practices that, when properly applied, will provide effective erosion and sedimentation control for all rainfall events. Some of the vegetative measures are temporary and permanent plants, mulches, and undisturbed buffers. There are many structural practices including diversions, sediment barriers and basins, waterways, etc. Properly designed, installed and maintained BMPs constitute a total defense against punitive actions by the EPD and the Local Issuing Authority. Should BMPs fail under less than the 25-year, 24-hour rainfall event,

then land-disturbers are subject to penalties of up to \$2,500 per day by the Issuing Authority and up to \$50,000-100,000 per day for water quality violations under the Georgia Water Quality Control Act. The storm water from a construction site should not increase the turbidity of the receiving waters by more than 25 Nephelometric Turbidity Units (NTUs) for warm water streams and by more than 10 NTUs for cold water streams (trout streams).

CONSERVATION AND ENGINEERING PRINCIPALS

The Law requires that BMPs conform to the criteria contained in The Manual for Erosion and Sediment Control in Georgia, which is published by the Conservation Commission.

Additionally, the Law requires that BMPs conform to the following principals:

1. LDAs shall be conducted so as to minimize erosion.
2. Cut and fill operations must be kept to a minimum.
3. Development plans must conform to topography and soil type, so as to create the lowest practicable erosion potential.
4. Whenever feasible, natural vegetation shall be retained, protected and supplemented.
5. The disturbed area and the duration of exposure to erosive elements shall be kept to a practicable minimum.
6. Disturbed soil shall be stabilized as quickly as practicable.
7. Temporary vegetation or mulching shall be employed to protect exposed critical areas during development.
8. Permanent vegetation and structural erosion control measures must be installed as soon as practicable.

9. To the extent necessary, sediment in runoff water must be trapped by the use of debris basins, sediment basins, silt traps, or similar measures until the disturbed area is stabilized. A disturbed area is stabilized when it is brought to a condition of continuous compliance with the requirements of the Law.

10. Adequate provisions must be provided to minimize erosion damage to cut and fill slopes.

11. Cuts and fills may not endanger adjoining property.

12. Fills may not encroach upon natural watercourses or constructed channels so as to adversely affect other property owners.

13. Grading equipment must cross flowing streams using bridges or culverts, except when they are not feasible; provided, in any case, that such crossing must be kept to a minimum.

14. LDA plans for E&SC shall include BMPs for the treatment or control of any sediment sources. They must also show adequate BMPs to retain sediments on site or preclude sedimentation of adjacent waters beyond the levels specified in section 12-7-6 (a) (2).

15. Except as provided in paragraph 16, LDAs shall not be conducted within 25 feet of the banks of any state waters, as measured horizontally from the point where vegetation has been wrested by normal stream flow or wave action, except where the Director of EPD allows a variance that is at least as protective of natural resources and the environment, or where a drainage structure or a roadway drainage structure must be constructed. Adequate erosion control measures must be incorporated in the project plans and implemented on site. Buffers of at least 25 feet established pursuant to provisions of the "Georgia Water Quality Control Act" shall

remain in force unless a variance is granted by the Director. The following requirements shall apply to any such buffer:

A. No LDAs shall be conducted within a buffer and a buffer shall remain undisturbed until all LDAs on the site are completed. Once the final stabilization of the site is achieved a buffer may be trimmed or thinned as long as long as the natural canopy is left in sufficient quantity. For single family construction, thinning or trimming of the buffer is allowed as long as the natural canopy is left in sufficient quantity.

B. The granting or denial of a variance request by the Director is based on the specific criteria of the rules adopted by the Board.

16. LDAs shall not be conducted within 50 horizontal feet as measured from the point where vegetation has been wrested by normal stream flow or wave action of any state waters classified as "trout streams" pursuant to the "Georgia Water Quality Control Act" except where a roadway Drainage structure must be constructed, provided that streams classified as trout streams which discharge an average annual flow of 25 gallons per minute or less may be piped by the landowner. See above sections A and B, paragraph 15, for buffer requirements.

PLANS AND PERMITS

All land disturbing activities covered by the E&S Act must first secure a Land Disturbing Activity (LDA) permit from the Local Issuing Authority. It is the responsibility of the property owner to obtain the LDA permit. The LDA application must be accompanied by a properly designed Erosion, Sedimentation & Pollution Control Plan. The LIA must forward the plan to the local Soil and Water Conservation District for approval unless they have entered into a Memorandum of Agreement with the local Soil and Water Conservation District.

The technical review of an ES&PC plan is conducted by the State Soil and Water Conservation Commission or Natural Resources Conservation Service. The Law requires that a permit be issued or denied within 45 days after a complete application and plan are submitted.

When the LDA is being conducted in a city or county where there is not a Local Issuing Authority, the Georgia Environmental Protection Division (EPD) Watershed Protection Branch will review the ES&PC plan and the GA EPD District Offices will conduct any enforcement action.

MEMORANDUM OF AGREEMENT

When a Local Issuing Authority has demonstrated the ability to review and approve ES&PC plans, It can enter into a Memorandum of Agreement (MOA) with the Soil & Water Conservation District to do plan review in-house. There are ~70 municipalities in the State of Georgia that have entered into this agreement with their local SWCD.

The National Pollutant Discharge Elimination System (NPDES) Permit

The Federal Clean Water Act and the Georgia Water Quality Control Act require the operator of an LDA to obtain a National Pollutant Discharge Elimination System (NPDES) Permit. This NPDES Permit regulates point source discharges of storm water to the waters of the State of Georgia from construction activities that will result in land disturbance equal to or greater than one (1) acre. As is the case with LDA permits issued pursuant to the Georgia Erosion and Sedimentation Act, the NPDES Permit requires that Best Management Practices (BMPs) be employed. The BMPs are described in this Manual. Further information regarding the NPDES Permit can be obtained from the Environmental Protection Division of the Georgia Department of Natural Resources.

Appendix A-2

Joining the Equivalent Best Management Practice List

The allowance of the efficient addition of proven BMPs that are at least as stringent as the Manual for Erosion & Sediment Control recognizes the dynamic growth and technological advancements in the area of BMP development.

Per the NPDES Permit, the use of an alternative BMP whose performance has been documented to be equivalent or superior to conventional BMPs as certified by a Design Professional may be allowed on a case-by-case basis, unless disapproved by EPD or GSWCC.

For a BMP to be considered for inclusion on the Equivalent BMP List, a Design Professional must have successfully completed the current process for Alternative BMP's as outlined by the GSWCC guidance document on at least 3 completed projects where EPD's Notice of Termination (NOT) form has been filed.

Geographic dispersion of the project sites is encouraged.

The following steps are required:

1. Provide pre-notice to EPD & GSWCC of the intent to apply for an Alternative BMP to be included on the Equivalent BMP List:

- A. Specify on the required checklist that accompanies the Notice of Intent Form that the project includes an Alternative BMP that will be included on an Application for the Equivalent BMP List.

- B. Inform GSWCC of the intent to apply by sending a digital copy of the approved ES&PC plan and a copy of the above to the GSWCC each time the NOI is filed with EPD.

2. Once the project involving the Alternative BMP has been completed and a Notice of Termination form for the project has been filed, submit to GSWCC the following:

A. An application to be on the Equivalent BMP List and a sample of the BMP.

B. Three sets - one for each time the Alternative BMP was used in three separate projects - of the required documentation to use the Alternative BMP, based on the current approval process as outlined by GSWCC guidance. Evidence of repeatable bench and field testing must be included as part of this documentation. Only approved ASTM standards or Overview Council-approved standards will be acceptable for repeatable bench testing; working test methods will not be accepted.

C. Three sets - one for each time the Alternative BMP was used in three separate projects - of the Notice of Termination form for each project involving the Alternative BMP.

D. A Certification form signed by 2 individuals - a Level II certified Design Professional and a Level IA or Level IB Certified Personnel - who evaluated the BMPs performance in the field stating that the Alternative BMP performed as expected throughout the life of each of the three projects.

E. Three sets of installation photos - one for each time the Alternative BMP was used - of the Alternative BMP utilized in the three projects.

F. Three sets of after-storm event photos - one for each time the Alternative BMP was used - of the Alternative BMP utilized in the three projects.

G. Any post-storm event inspection records as well as inspection and enforcement records made by any federal, state, or local regulatory agency related to this specific BMP on any of the 3 projects.

Construction Checklist of BMPs And Minimum Requirements

Project Name & File No. _____

Inspection Date: _____

Time: _____

Inspected by: _____

Stage of Construction

___ Pre-Construction Phase

___ Construction Phase

___ Building Phase

___ Final Stabilization

| CHECK DAM | | Cd |
|---|--------|--------|
| Minimum Requirement | Passed | Failed |
| Center: 9" lower than outer edges. | | |
| Side Slopes: 2:1 or flatter | | |
| Spacing: Toe of upstream dam is at the same elevation as the top of the downstream dam. | | |
| Geotextile: Placed between the rock and its soil foundation. | | |
| Maintenance: Sediment removed when depth reaches 1/2 the original dam height. Dam removed and area stabilized when useful life has expired. | | |

| CHANNEL STABILIZATION | | (Ch) |
|---|--------|--------|
| Minimum Requirement | Passed | Failed |
| Installation: Channel lining installed immediately after grading and vegetate all bare areas. | | |
| Riprap Lining: Graded to 1.5:1 or less. A filter blanket, at least 6" thick, of sand, gravel, and/or geotextile material should be between soil and riprap. | | |
| Outlet: Adequate outlet for free flow of water from flood plains into channel. | | |
| Clearing: Objectionable materials removed from the channel. As many trees preserved, as possible. | | |
| Buffers: Preserved by clearing for soil placement on one side of channel only. Buffers re-established with appropriate vegetation. | | |
| Maintenance: Inspected periodically and necessary repairs made immediately. | | |

| CONSTRUCTION EXIT | | (Co) |
|--|--------|--------|
| Minimum Requirement | Passed | Failed |
| Aggregate Size: 1.5"-3.5" | | |
| Pad Thickness: 6" minimum | | |
| Pad Width: 20 ft minimum | | |
| Pad Length: 50 ft minimum | | |
| Location: At all exit points. | | |
| Geotextile: Placed the full length and width of the exit. | | |
| Maintenance: Peiodic top dressing with 1.5"-3.5" stone as conditions demand. | | |

| CONSTRUCTION ROAD STABILIZATION | | (Cr) |
|--|--------|--------|
| Minimum Requirement | Passed | Failed |
| Aggregate Size: 1.5"-3.5" | | |
| Pad Thickness: 8"-10" | | |
| Pad Width: 14 ft minimum. | | |
| Maintenance: Peiodic top dressing with 1.5"-3.5" stone as conditions demand. | | |

| STREAM DIVERSION CHANNEL (Dc) | | |
|--|--------|--------|
| Minimum Requirement | Passed | Failed |
| Size: Channel width should be a minimum of 6 ft with side slopes flatter than 2:1. | | |
| Lining: The liner should consist of geotextile or class I riprap. | | |
| Maintenance: Inspected daily for construction material positioning. | | |

| DIVERSION (Di) | | |
|---|--------|--------|
| Minimum Requirement | Passed | Failed |
| Site Preparation: Trees, brush, stumps, and other objectionable material have been removed. | | |
| Fills: All fills have been compacted. All un-needed excavated material has been disposed of and stabilized. Ridge should be at least 10 ft wide. Add 10% height for settlement. | | |
| Stabilization: Channel outlets have adequate vegetation, riprap, and/or concrete. | | |
| Maintenance: Inspected frequently and after each rainfall. Necessary repairs made immediately. | | |

| (Dn1) DOWNDRAIN STRUCTURE (Dn2) | | |
|---|--------|--------|
| Minimum Requirement | Passed | Failed |
| Location: On un-disturbed soil or well-compacted fill. | | |
| Outlet: Stabilized with rock riprap. | | |
| Pipe: Heavy duty, flexible tubing staked at 10 ft intervals for temporary structure. Joints are well-connected and watertight. | | |
| Maintenance: Check after every rainfall. Necessary repairs made promptly. Temporary structure removed after useful life. Exposed areas stabilized | | |

| FILTER RING | | Fr |
|--|--------|--------|
| Minimum Requirement | Passed | Failed |
| Size: At inlets with a diameter less than 12", the stone size should be 3"-5" | | |
| Size: At inlets with a diameter greater than 12", the stone size should be 10"-15" | | |
| Height: The filter ring should have a minimum height of 2 ft from grade. | | |
| Maintenance: The ring should be kept clear of trash and debris, and the sediment should be removed at 1/2 full | | |

| GABION | | Ga |
|--|--------|--------|
| Minimum Requirement | Passed | Failed |
| Design: Designed and installed by a professional familiar with the use of gabions | | |
| Maintenance: Periodically inspected for signs of undercutting or excessive erosion | | |

| GRADE STABILIZATION STRUCTURE | | Gr |
|--|--------|--------|
| Minimum Requirement | Passed | Failed |
| Materials: Constructed of concrete, rock, masonry, steel, aluminum, or treated wood. | | |
| Outlet: Adequate, stable outlet for discharge. | | |
| Vegetation: On all disturbed areas. | | |
| Maintenance: Periodically inspected for signs of undercutting or periodic erosion. | | |

| LEVEL SPREADER | | Lv |
|--|--------|--------|
| Minimum Requirement | Passed | Failed |
| Grade: No greater than 1% for the last 15 ft of the dike or diversion. | | |
| Length: Determined by the design professional from estimated storm flow. | | |
| Outlet: Discharges onto an undisturbed stabilized area to create uniform sheet flow. | | |
| Maintenance: No blockages at point of discharge. | | |

| ROCK FILTER DAM | | Rd |
|--|--------|--------|
| Minimum Requirement | Passed | Failed |
| Height: The dam center shall be 9" lower than the outer edge and not higher than the channel banks. | | |
| Side Slopes: 2:1 or flatter | | |
| Location: Located so that it will not cause flooding of upstream property. | | |
| Rock Size: Determined by the design criteria set forth in Appendix C of the Manual | | |
| Top Width: 6 ft or greater | | |
| Maintenance: Sediment removed when it reaches a depth of 1/2 the original height of the dam. Remove dam at the end of its useful life. | | |

| RETAINING WALL | | Re |
|--|--------|--------|
| Minimum Requirement | Passed | Failed |
| Design: Designed and installed by a professional familiar with the use of retaining walls. | | |
| Maintenance: Periodically inspected for signs of undercutting or excessive erosion. | | |

| RETROFIT | | (Rt) |
|--|--------|--------|
| Minimum Requirement | Passed | Failed |
| Height: 1/2 the height of the outlet control structure | | |
| Half-Round Pipe: Diameter should be 1.5x the principal pipe outlet diameter. | | |
| Slotted Board Dam: Minimum posts size of 4"x4". The spacing between shall be 0.5"-1.0" | | |
| Stone Size: 3-4" stone | | |
| Pond Inlet: Sediment entry point should be at opposite end of basin from outlet. If not, baffles shall be installed | | |
| Maintenance: Trash and debris hindering drainage shall be removed. Sediment removed when structure is 1/3 full. Structure removed when final stabilization achieved. | | |

| SEDIMENT BARRIER | | (Sd1) |
|---|--------|--------|
| Minimum Requirement | Passed | Failed |
| Location: Intended for areas where sheet flow occurs. Installed along the contour. Where state waters are present, 2 rows of Type "S" is installed. | | |
| Brush Barrier: Wind-rowed on the contour. Width should be between 5-10 ft and height should be between 3-5 ft. | | |
| Silt Fence: Verify fabric type and support spacing for each application. Entrenched to a depth of 6". Verify post size. | | |
| Maintenance: Sediment removed at 1/2 the original height of the barrier. Product replaced when it cannot maintain 80% of properly installed height. Removed once final stabilization has occurred | | |

| INLET SEDIMENT TRAP | | (Sd2) |
|---|--------|--------|
| Minimum Requirement | Passed | Failed |
| Excavated: A minimum depth of 1.5 ft is provided. Side slopes should be 2:1 or flatter. | | |
| Fabric & Frame: Steel posts are used. Fabric is entrenched at least 12" and fabric is securely fastened to the posts. | | |
| Curb Inlet: 8" concrete blocks wrapped in filter fabric or gravel bags consisting of #57 stone wrapped in filter fabric or equivalent material. | | |
| Gravel: 3" in diameter or larger stone placed on slope toward the inlet. 1/2"-3/4" gravel placed on slope away from inlet. | | |
| Maintenance: Sediment removed when accumulation has reached 1/2 the height of the trap. Remove once contributing drainage basin has been stabilized | | |

| TEMPORARY SEDIMENT BASIN | | (Sd3) |
|--|--------|--------|
| Minimum Requirement | Passed | Failed |
| Location: Not placed in a live stream | | |
| Principal Spillway: Vertical pipe should extend through the embankment and exit beyond the downstream toe of the fill. All pipe and riser connections should be watertight. Pipe should be a minimum of 8" in diameter | | |
| Riser: 1/2" perforations spaced 3" apart covered with 2 ft of 3"-4" stone. Embedded 9" into an 18" thick concrete base. | | |
| Emergency Spillway: Constructed on undisturbed ground. Minimum bottom width of 8 ft. Stabilized with vegetation, riprap, or concrete. | | |
| Maintenance: All damages caused by erosion or equipment repaired before the end of each day. Sediment removed when 1/3 of the storage volume has been lost. | | |

| TEMPORARY SEDIMENT TRAP (Sd4) | | |
|---|--------|--------|
| Minimum Requirement | Passed | Failed |
| Depth: Maximum depth is 4 ft | | |
| Overflow: The maximum permanent wet depth is 2 ft. Slopes are less than 2%. | | |
| Combination: The maximum depth of ponded water is 12". | | |
| Rock: Height of the embankment is not greater than 5.5 ft. The top width is at least 3 ft. Slopes do not exceed 2:1. | | |
| Maintenance: All damages caused by erosion or equipment repaired before the end of each day. Sediment removed when 1/3 of the storage volume has been lost. | | |

| FLOATING SURFACE SKIMMER (Sk) | | |
|--|--------|--------|
| Minimum Requirement | Passed | Failed |
| Excavation Pit: 4 x 4 x 2 ft pit filled with riprap under the skimmer. Must be lower than the invert of the outlet barrel of the riser. | | |
| Apparatus: Schedule 40 or greater PVC or other appropriate materials | | |
| Maintenance: Use a floatable rope to remove trash and debris that accumulates on the outside of guard. Free skimmer from being stuck in the mud. | | |

| SEEP BERM | | (SpB) |
|--|--------|--------|
| Minimum Requirement | Passed | Failed |
| Location: Not located above fill slopes that have not achieved permanent stabilization. Not located across streams, ditches, or waterways. | | |
| Berm: Minimum width of 12" and height of 4 ft. Compacted by mechanical equipment. | | |
| Vegetation: Planted with seed that has 70% or better germination | | |
| Spacing: The toe of the upstream dike is at the same elevation as the top of downstream dike. | | |
| Maintenance: Inspect after every 1/2" rainfall or greater. Remove sediment when accumulation is 1/3 the height of the intermediate dike | | |

| TEMPORARY STREAM CROSSING | | (Sr) |
|---|--------|--------|
| Minimum Requirement | Passed | Failed |
| Size: Large enough to convey full bank flow without appreciably altering the stream flow characteristics. | | |
| Location: Installed perpendicular to the stream. | | |
| Overflow Protection: Elevated crossings, crown fills over pipes, or diversions and dikes. | | |
| Maintenance: Inspect after every rainfall and at least once a week. | | |

| STORM DRAIN OUTLET PROTECTION | | St |
|--|--------|--------|
| Minimum Requirement | Passed | Failed |
| Alignment: The apron is properly aligned and preferably straight throughout its length | | |
| Grade: Constructed at 0% grade with no overfall at the end. The top of the riprap at the downstream end is level with the receiving channel. Compacted any required fill. | | |
| Filter Fabric: Gravel filter or Geotextile installed between the riprap and subgrade. Fabric is free of any punching or tears. Gravel filter is properly graded and installed according to the manufacturer's recommendation | | |
| Riprap Thickness - 1.5x the maximum stone diameter Upstream Width - 3x the diameter of the outlet pipe Length of Apron - Refer to Plan | | |
| Maintenance: Inspect riprap outlet structures after heavy rain events. Make repairs immediately. | | |

| SURFACE ROUGHENING | | Su |
|---|--------|--------|
| Minimum Requirement | Passed | Failed |
| Steeper than 3:1: Roughened by either Stair-Step Grading, Grooving, or Tracking | | |
| Flatter than 3:1: Soils loosened to a depth of 2"-4" | | |
| Stair-Step Grading: Maximum depth of 30"-40" Maximum width of 40"-50" | | |
| Grooving: Un-Mowed slopes with a minimum depth of 3" and maximum spacing of 15". Mowed slopes with a minimum depth of 1" and maximum spacing of 12" | | |
| Tracking: Not recommended on clay soils. Sandy soils may be tracked. | | |
| Vegetation: Roughened areas are seeded and mulched immediately after roughening | | |

| TURBIDITY CURTAIN | | (Tc) |
|--|--------|--------|
| Minimum Requirement | Passed | Failed |
| Location: Barrier placed 25 ft outside of the construction area where possible. Curtain placed parallel to flow. | | |
| Water Body: Not altered by the installation of the curtain. | | |
| Filling: Required permits and variances have been obtained and allowable limits have not been exceeded. | | |
| Maintenance: Removed when no longer needed. Excess sediment carefully removed. | | |

| TOPSOILING | | (Tp) |
|---|--------|--------|
| Minimum Requirement | Passed | Failed |
| Stripping: Confined to the immediate construction area with a typical depth of 4"-6." Topsoil is friable, loamy, and free of debris and objectionable rock. | | |
| Stockpile: Located where natural drainage is not obstructed and contained by a sediment barrier. Stabilized with temporary vegetative measures | | |
| Spreading: Applied at a uniform depth of 5". Subsoil has been loosened and agricultural lime added as required | | |

| TREE PROTECTION | | (Tr) |
|--|--------|--------|
| Minimum Requirement | Passed | Failed |
| Fence: Orange plastic fabric stapled to 2x4 treated wood stakes. Treated wood fencing with orange fabric attached used for single family homes | | |
| Protection Zone: Local government contacted regarding tree ordinances and critical rooting distance | | |

VEGETATED WATERWAY**Wt**

| Minimum Requirement | Passed | Failed |
|--|---------------|---------------|
| Channel: Free of all trees, bank projections, and other objectionable material that will impeded normal flow. Shaped to desired cross section and stabilized in accordance vegetative standards. | | |
| Fill: Compacted as needed. Excess fill disposed of in an appropriate manner | | |

| BUFFER ZONE | | Bf |
|--|--------|-----------|
| Minimum Requirement | Passed | Failed |
| Width: For warm water fisheries, a minimum of 25 ft from the point of wrested vegetation shall be protected. For cold water fisheries, a minimum of 50 ft from the point of wrested vegetation shall be protected. | | |
| Maintenance: Area closet to the stream is maintained at all times with minimal impact from equipment. | | |
| Variance: A variance is required for any work inside State mandatad buffers | | |

| COASTAL DUNE STABILIZATION | | Cs |
|--|--------|-----------|
| Minimum Requirement | Passed | Failed |
| Location: 100-140 ft depending on wind conditions from the mean high tide line. | | |
| Posts: Minimum length of 7 ft with a minimum diameter of 3". Spacing should be 10 ft apart and entrenched to a depth of 3 ft. | | |
| Snow Fence: Standard commercial 4 ft high snow fence with a slat spacing of 1-1/4". Fencing should be spaced 30-40 ft apart. | | |
| Placement: Placed perpendicular to the prevailing winds. When winds are parallel to water, an additional 30 ft section should be placed perpendicular to the original fence. | | |
| Vegetation: Established immediately following dune development. Irrigate is necessary. | | |
| Preservation: Dunes protected from human and vehicular traffic. Crosswalks provided for beach access. | | |

| DISTURBED AREA STABILIZATION (WITH MULCHING ONLY) | | Ds1 |
|--|--------|------------|
| Minimum Requirement | Passed | Failed |
| Preparation: Soil loosened to a minimum depth of 3" | | |
| Application: Applied by hand or mechanical equipment. | | |
| Anchoring: Anchored with a disk harrow or tackifier. Polyethylene film entrenched at the top | | |
| Materials & Related Depths Straw or Hay - 2" to 4" Wood waste/chips - 2" to 3" | | |

| DISTURBED AREA STABILIZATION (WITH TEMPORARY SEEDING) | | Ds2 |
|--|--------|------------|
| Minimum Requirement | Passed | Failed |
| Preparation: Soil should be loose and friable. Soil should be scarified when sealed by rainfall. | | |
| Lime & Fertilizer: Applied at a rate determined by the soil pH. | | |
| Seeding: Plant species selected based on site and soil conditions, area, and time of year. | | |
| Irrigation: Applied at a rate that will not cause runoff and erosion. | | |
| Mulch: Placed after seeding to retain moisture. | | |

| DISTURBED AREA STABILIZATION (WITH PERMANENT SEEDING) | | Ds3 |
|--|--------|--------|
| Minimum Requirement | Passed | Failed |
| Preparation: Soil should be loose and friable. Soil should be scarified when sealed by rainfall. | | |
| Lime & Fertilizer: Applied at a rate of 1-2 tons/acre unless soil tests indicate otherwise. Refer to Manual for 2nd & 3rd year fertilizer rates. | | |
| Seeding: Plant species selected based on site and soil conditions, area, and time of year. | | |
| Mulch: Applied in accordance with Ds1 specifications | | |
| Irrigation: Applied at a rate that will not cause runoff and erosion. | | |
| Mowing: 6" of top growth maintained at all times | | |

| DISTURBED AREA STABILIZATION (WITH SODDING) | | Ds4 |
|--|--------|--------|
| Minimum Requirement | Passed | Failed |
| Surface: Soil surface is brought to final grade and clear of any trash, debris, and clods larger than 1". | | |
| Installation: Sod applied to soil surface only (not to frozen or gravel type soils). Cut and installed within 36 hours of digging. | | |
| Lime & Fertilizer: Applied based on soil tests or at a rate of 1-2 tons/acre. | | |
| Anchoring: Sod should be anchored with pins on slopes steeper than 3:1. | | |
| Irrigation: Used as a supplement to rainfall for a minimum of 2-3 weeks. | | |
| Mowing: Grass height should not be cut less than 2"-3". | | |

| DUST CONTROL | | Du |
|---|--------|--------|
| Minimum Requirement | Passed | Failed |
| Methods: Mulch, vegetation, tackifiers, or irrigation used to prevent surface and air movement of dust. | | |

| FLOCCULANTS & COAGULANTS FI-Co | | |
|--|--------|--------|
| Minimum Requirement | Passed | Failed |
| Application: Conforms to manufacturer's guidelines. | | |
| Type: Only anionic forms shall be used. | | |
| Location: Intended for use in construction storm water ditches that feed ponds or basins. Not intended for use to surface waters of the state. | | |

| STREAMBANK STABILIZATION (WITH PERMANENT VEGETATION) Sb | | |
|--|--------|--------|
| Minimum Requirement | Passed | Failed |
| Design: Designed and installed by a professional familiar with the process. | | |
| Materials: None used that could be poisonous to fish or aquatic life. | | |
| Runoff: Diverted away from the area being treated. | | |
| Side Slope: Should be 2:1 or flatter. | | |
| Work Sequence: Work started at an upstream stable point along the bank. | | |
| Stake Health: Cut with a saw. Planted the same day as prepared. Buds upward. Split, stripped, and mushroomed cuttings replaced. | | |
| Stake Installation: Begins at water's edge and works up the bank. | | |
| Vegetation: Native trees and shrubs. | | |
| Inspection: Checked regularly for wash-outs, undercutting, unhealthy vegetation, especially after heavy rains. Make necessary repairs immediately. | | |
| Maintenance: All failures fixed with structural materials, new plants, and mulch immediately. | | |

| SLOPE STABILIZATION | | Ss |
|---|--------|-----------|
| Minimum Requirement | Passed | Failed |
| Installation: Conforms to manufacturer's guidelines for installation of HECPs & RECPs | | |
| Maintenance: Inspected periodically after installation. All materials reinstalled after washouts or breakage. | | |

| TACKIFIERS | | Tac |
|---|--------|------------|
| Minimum Requirement | Passed | Failed |
| Specifications: Used as tie-down for soil, compost, seed, straw, hay, or mulch. Only anionic forms shall be used. | | |
| Installation: Installed according to the manufacturer's guidelines. | | |

GLOSSARY

The list of terms that follows is representative of those used by soil scientists, engineers, developers, conservationist planners, etc. The terms are not necessarily used in the text, nonetheless they are in common use in conversation matters.

AASHTO CLASSIFICATION (soil engineering) -- The official classification of soil materials and soil aggregate mixtures for highway construction used by the American Association of State Highway Transportation Officials.

ACID SOIL -- A soil with a pH value less than 7.0. The term is usually applied to the surface layer or to the root zone unless specified otherwise.

ACRE-FOOT -- The volume of water that will cover 1 acre to a depth of 1 foot.

AGGRADATION -- The process of building up a surface by deposition.

ALKALINE SOIL -- A soil that has a pH greater than 7.0, particularly above 7.3.

ALLUVIAL -- Pertaining to material that is transported and deposited by running water.

ALLUVIAL LAND -- Areas of unconsolidated alluvium, generally stratified and varying wildly in texture, recently deposited by streams, and subject to frequent flooding.

ALLUVIUM -- A general term for all detrital material deposited or in transit by streams, including gravel, sand, silt, clay, and all mixtures of these.

ANGLE OF REPOSE -- The angle between the horizontal and the maximum slope that a soil assumes through natural processes.

ANTI-SEEP COLLAR -- A device constructed around a pipe or other conduit and placed through a dam, levee or dike for the purpose of reducing seepage losses and piping failures.

ANTI-VORTEX DEVICE -- A facility placed at the entrance to a pipe conduit structure, such as a drop inlet spillway or hood inlet spillway, to prevent air from entering the structure when the pipe is flowing full.

APRON (soil engineering) -- A floor or lining to protect a surface from erosion. An example is the pavement below chutes, spillways, or at the toes of dams.

AUXILIARY SPILLWAY -- A dam spillway built to carry runoff in excess of that carried by the principal spillway. See Emergency Spillway.

BACKFILL -- The material used to refill a ditch or other excavation, or the process of doing so.

BEDROCK -- The solid rock underlying soils and the regolith in depths ranging from zero (where exposed by erosion) to several hundred feet.

BEDLOAD -- The sediment that moves by sliding, rolling or bounding on or very near the streambed.

BEST MANAGEMENT PRACTICES (BMPs) -- A collection of structural practices and vegetative measures which, when properly designed, installed and maintained, will provide effective erosion and sedimentation control for all rainfall events up to and including a 25-year, 24-hour rainfall event.

BLINDING MATERIAL -- Material placed on top and around a closed drain to improve the flow of water to the drain and to prevent displacement

- during back-filling of the trench.
- BLIND INLET** -- An inlet to a drain in which the entrance of water is by percolation rather than open flow channels.
- BORROW AREA** -- A source of earth fill material used in the construction of embankments or other earthfill structures.
- BOTTOM LANDS** -- A term often used to define lowlands adjacent to streams.
- BOX-CUT** -- The initial cut driven in a property where no open side exists that results in a highwall on both sides at the cut.
- BRUSH MATTING** -- (1) A matting of branches placed on badly eroded land to conserve moisture and reduce erosion while trees or other vegetative covers are being established. (2) A matting of mesh wire and brush used to retard stream bank erosion.
- CHANNEL** -- A natural stream that conveys water; a ditch or channel excavated for the flow of water. See Watercourse.
- CHANNEL IMPROVEMENT** -- The improvement of the flow characteristics of a channel by clearing, excavating, realignment, lining, or other means in order to increase its capacity.
- CHANNEL SLOPE** -- Natural or excavated sides (banks) of a watercourse.
- CHANNEL STABILIZATION** -- Erosion prevention and stabilization of velocity distribution in a channel using jetties, drops, revetments, vegetation, and other measures.
- CHANNEL STORAGE** -- Water temporarily stored in channels while en route to an outlet.
- COLLOID** -- In soil, organic or inorganic matter having very small particle size and a corresponding large surface area per unit of mass.
- COAGULANT** -- A substance used to neutralize the repulsive electrical charge surrounding a particle.
- COMPACTION** -- The process by which silt grains are rearranged to decrease void space and bring them into closer contact with one another, thereby increasing the weight of solid material per cubic foot.
- CONDUIT** - - Any channel intended for the conveyance of water, whether open or closed.
- CONSERVATION** -- The protection, improvement and use of natural resources according to principles that will assure their highest economic or social benefit.
- CONSERVATION DISTRICT** -- A public organization created under state enabling law as a special purpose district to develop and carry out a program of soil, water and related resource conservation use and development within its boundaries.
- CONTOUR** -- (1) An imaginary line on the surface of the earth connecting points of the same elevation. (2) A line drawn on a map connecting points of the same elevation.
- COVER CROP** -- A close-growing crop grown primarily for the purpose of protecting and improving soil between periods of permanent vegetation.
- CRADLE** -- A device, usually concrete, used to support a pipe conduit or barrel.
- CREEP (soil)** -- A slow mass movement of soil and soil material down relatively steep slopes.
- CRITICAL AREA** -- A severely eroded, sediment-producing area that requires special management to establish and maintain vegetation.

- CUT** -- A portion of land surface or area from which earth has been removed or will be removed by excavation; the depth below the original ground surface to the excavated surface. Syn. Excavation.
- CUT-AND-FILL** -- The process of earth moving by excavating part of an area and using the excavated material for adjacent embankments or fill areas.
- CUTOFF** -- A wall, collar or other structure, such as a trench, filled with relatively impervious material intended to reduce seepage of water through porous strata.
- DAM** -- A barrier to confine or raise water for storage or diversion, to create a hydraulic head, to prevent gully erosion or for retention of soil, rock, or other debris.
- DEBRIS** -- The loose material arising from the disintegration of rocks and vegetative material; transportable by streams, ice, or floods.
- DEBRIS DAM** -- A barrier built across a stream channel to retain rock, sand, gravel, silt, or other material.
- DEBRIS GUARD** -- A screen or grate at the intake of a channel, drainage, or pump structure for the purpose of stopping debris.
- DEGRADATION** -- To wear down by erosion, especially through stream action.
- DESIGN LIFE** -- The period of time for which a facility is expected to perform its intended function.
- DESILTING AREA** -- An area of grass, shrubs or other vegetation used for deposition of silt and other debris from flowing water.
- DETENTION DAM** -- A dam constructed for the purpose of temporary storage of streamflow or surface runoff and for releasing the stored water at controlled rates.
- DIKE (engineering)** -- An embankment to confine or control water built along the banks of a river to prevent overflow of lowlands.
- DIKE (geology)** -- A tabular body of igneous rock that cuts across the structure of adjacent rocks or massive bodies.
- DISCHARGE (hydraulics)** -- The volume of fluid passing a point per unit time, commonly expressed as cubic feet per second, million gallons per day, gallons per minute, or cubic meters per second.
- DISPERSION, SOIL** -- The breaking down of soil aggregates into individual particles, resulting in a single-grain structure.
- DIVERSION** -- A channel, with or without a supporting ridge on the lower side, constructed across the top or bottom of a slope to intercept surface runoff.
- DIVERSION DAM** -- A barrier built to divert part or all of the water from a stream into a different course.
- DRAIN** -- (1) A buried pipe or other conduit (closed drain). (2) A ditch (open drain) for carrying off surplus surface water or groundwater. (3) To provide channels, such as open ditches or closed drains, so that excess water can be removed by surface flow or by internal flow. (4) To lose water (from the soil) by percolation.
- DRAINAGE** -- (1) The removal of excess surface water or ground water from land by means of surface or subsurface drains. (2) Soil characteristics that affect natural drainage.
- DRAINAGE, SOIL** -- The frequency and duration of periods when the soil is free of saturation. The following classes are used to describe soil drainage:

WELL DRAINED -- Excess water drains away rapidly and mottling occurs within 36 inches of the surface.

MODERATELY WELL DRAINED -- Water is removed from the soil somewhat slowly resulting in small but significant periods of wetness. Mottling occurs between 8 to 18 inches.

SOMEWHAT POORLY DRAINED -- Water is removed from the soil slowly enough to keep it wet for significant periods but not all of the time. Mottling occurs between 0 to 18 inches.

VERY POORLY DRAINED -- Water is removed so slowly that the water table remains at or near the surface for the greater part of the time. The soil has a black to gray surface layer with mottles up to the surface.

DRAWDOWN -- The lowering of the water surface (in open channel flow), water table, or piezometric surface (in groundwater flow) resulting from a withdrawal of water.

DROP-INLET SPILLWAY -- An overfall structure in which the water drops through a vertical riser connected to a discharge conduit.

DROP SPILLWAY -- An overfall structure in which the water drops over a vertical wall onto an apron at a lower elevation.

DROP STRUCTURE -- A structure for dropping water to a lower level and dissipating its surplus energy; a fall. A drop may be vertical or inclined.

EARTH DAM -- A dam constructed of compacted soil material.

EMBANKMENT -- A man-made deposit of soil, rock, or other material used to form an impoundment.

EMERGENCY SPILLWAY -- A spillway used to carry runoff exceeding a given design flood. Syn. Auxiliary Spillway.

ENERGY DISSIPATOR -- A device used to reduce the energy of flowing water.

ERODIBLE (geology and soils) -- Susceptible to erosion.

EROSION -- (1) The wearing away of the land surface by running water, wind, ice, or other geological agents, including such processes as gravitational creep. (2) Detachment and movement of soil or rock fragments by water, wind, ice or gravity. The following terms are used to describe different types of water erosion:

ACCELERATED EROSION -- Erosion much more rapid than normal, primarily as a result of the influence of the activities of man.

GEOLOGICAL EROSION -- The normal or natural erosion caused by geological processes acting over long geologic periods.

GULLY EROSION -- The erosion process whereby water accumulates in narrow channels and, over short periods, removes the soil from this narrow area.

NATURAL EROSION -- The wearing away of the Earth's surface by water, ice, or other natural agents under natural environmental conditions.

NORMAL EROSION -- The gradual erosion of land used by man which does not greatly exceed natural erosion.

RILL EROSION - An erosion process in which numerous small channels, only several inches deep, occur mainly on recently disturbed and exposed soils.

SHEET EROSION - The removal of a fairly uniform layer of soil

from the land surface by runoff water.

SPLASH EROSION - The spattering of small soil particles caused by the impact of raindrops on wet soils.

EROSION AND SEDIMENTATION CONTROL PLAN - A plan for the control of erosion and sediment resulting from a land-disturbing activity.

EROSION CLASSES (soil survey) -- A grouping of erosion conditions based on the degree of erosion or characteristics patterns.

EROSIVE - Having sufficient velocity to cause erosion; refers to wind or water. Not to be confused with erodible as a quality of soil.

ESCARPMENT -- A steep face or ridge of highland.

EXISTING GRADE -- The vertical location of the existing ground surface prior to cutting or filling.

FERTILIZER -- Any organic or inorganic material of natural or synthetic origin that is added to a soil to supply elements essential to growth.

FERTILIZER ANALYSIS -- The percentage composition of fertilizer, expressed in terms of nitrogen (N), phosphoric acid (P), and potash (K).

FILLING -- The placement of any soil or other solid material, either organic or inorganic, on a natural ground surface or an excavation.

FILTER STRIP -- A long, narrow vegetative planting used to retard or collect sediment.

FINAL CUT -- The last cut or line of excavation made when mining a specific property or area.

FINISHED GRADE -- The final grade or elevation of the ground surface.

FLOCCULANT -- A substance that promotes the clumping of particles.

FLOOD -- An overflow or inundation that comes from a river or other body of water and causes or threatens damage.

FLOOD CONTROL -- Methods or facilities for reducing flood flows.

FLOODPLAIN -- Nearly level land situated on either side of a channel which is subject to overflow flooding.

FLOOD STAGE -- The stage at which overflow of the natural banks of a stream begins to cause damage.

FLUME - A device constructed to convey water on steep grades lined with erosion resistant materials.

FREEBOARD (hydraulics) -- Vertical distance between the maximum water surface elevation anticipated in design and the top of retaining banks or structures provided to prevent overtopping because of unforeseen conditions.

GAGE OR GAUGE -- A device for registering precipitation, water level, discharge, velocity, pressure, temperature, etc.

.GEOTEXTILE -- A term used to describe woven or non-woven fabric materials used to reinforce or separate soil and other materials.

GRADATION (geology) -- The bringing of a surface or streambed to grade by running water.

GRADE -- (1) The slope of a road, channel, or natural ground. (2) The finished surface of a canal bed, roadbed, top of embankment, or bottom of excavation; any surface prepared for the support of construction like paving or laying a conduit. (3) To finish the surface of a canal bed, roadbed, top of embankment, or bottom of excavation.

GRADED STREAM -- A stream in which, over a period of years, the slope is delicately adjusted to provide, with available discharge and with prevailing channel characteristics, just the velocity required for

transportation of the sediment load from the drainage basin

GRADE STABILIZATION STRUCTURE -- A structure stabilizing the grade of a gully or other watercourse, thereby preventing further headcutting or lowering of the channel grade.

GRADIENT -- Change of elevation, velocity, pressure or other characteristics per unit length; slope.

GRADING -- The altering surfaces to specified elevations, dimensions, and/or slopes.

GRASS -- A member of the botanical family Gramineae, characterized by bladelike leaves arranged on the culm or stem in 2 ranks.

GRASSED WATERWAY -- A natural or constructed waterway, usually broad and shallow, covered with erosion-resistant grasses, used to conduct surface water from cropland.

GULLY -- A channel or miniature valley cut by concentrated runoff sufficiently deep that it would not be obliterated by normal tillage operations.

HABITAT -- The environment in which the life needs of a plant or animal organism, population, or community are supplied.

HEAD (hydraulics) -- (1) The height of water above any plane of reference. (2) The energy, either kinetic or potential, possessed by each unit weight of liquid. (3) The internal pressure expressed in ft or lbs per sq. in. of an enclosed conduit.

HEAD GATE -- A water control structure; the gate at the entrance to a conduit.

HEAD LOSS -- The energy loss due to friction, eddies, changes in velocity, or direction of flow.

HEADWATER -- (1) The source of the stream. (2) The water upstream from a structure or point on a stream.

HOOD INLET -- The entrance of a closed conduit that has been shaped to induce full flow at minimum water surface elevation.

HYDROGRAPH -- A graph showing variation in stage (depth) or discharge of a stream over a period of time.

IMPOUNDMENT -- An artificial collection or storage of water, as a reservoir, pit, dugout, sump, etc.

INFILTRATION -- The gradual downward flow of water from the surface through soil to ground water and water table reservoirs.

INFILTRATION RATE -- A soil characteristic determining or describing the maximum rate at which water can enter the soil under specified conditions.

INLET (hydraulics) -- (1) A surface connection to a closed drain. (2) A structure at the diversion end of a conduit. (3) The upstream end of any structure through which water may flow.

INOCULATION -- The process of introducing pure or mixed cultures or micro-organisms into natural or artificial media.

INTAKE -- (1) The headworks of a conduit, the place of diversion. (2) The entry of water into soil.

INTAKE RATE -- The rate of entry of water into soil.

INTENSITY -- The rate of rainfall expressed in inches/hour.

INTERCEPTION (hydraulics) The process by which precipitation is caught and helped by foliage, twigs, and branches of trees, shrubs, and other vegetation.

INTERCEPTION CHANNEL -- A channel excavated at the top of earth cuts, at the foot of slopes or at other critical places to intercept surface flow; a catch drain.

INTERCEPTOR DRAIN -- A surface or subsurface drain, or a combination of both, designed and installed to intercept flowing water.

INTERFLOW -- That portion of rainfall that infiltrates into the soil and moves laterally through the upper soil horizons until intercepted by a stream channel or until it returns to the surface at some point downslope from its point of infiltration.

INTERMITTENT STREAM -- A stream, or portion of a stream, that flows only in direct response to precipitation. It receives little or no water from springs and no long-continued supply from melting snow or other sources. It is dry for a large part of the year, ordinarily more than three months.

INTERNAL SOIL DRAINAGE -- The downward movement of water through the soil profile.

LAND -- The total natural and cultural environment in which production takes place.

LAND CAPABILITY -- The suitability of land for use without permanent damage.

LAND CLASSIFICATION -- The arrangement of land units into various categories based on the properties of the land or its suitability for some particular purpose.

LAND-DISTURBING ACTIVITY -- Any land change which may result in soil erosion from water or wind and the movement of sediments into State water or onto lands within the State, including, but not limited to, clearing, dredging, grading, excavating, transporting, and filling of land.

LAND FORM -- A discernible natural landscape.

LAND RECLAMATION -- Making the land capable of more intensive use by changing its general character.

LEACHING -- The removal from the soil in solution of the more soluble materials by percolating waters.

LEGUME -- A member of the legume or pulse family, such as the peas, beans, peanuts, clover, alfalfas, sweet clovers, lespedezas, vetches and kudzu. Practically all legumes are nitrogen-fixing plants.

LEVEL SPREADER -- A shallow channel excavation at the outlet end of a diversion with a level section for the purpose of diffusing the diversion outflow.

LIME -- From the strictly chemical standpoint, refers to only one compound, calcium oxide (CaO); however, the term "lime" can include a great variety of materials which are usually composed of the oxide, hydroxide or carbonate of calcium or of calcium and magnesium.

LIME, AGRICULTURAL -- A soil amendment consisting principally of calcium carbonate.

LIMING -- The application of lime to the land surface.

LIQUEFICATION -- The sudden large decrease of the shearing resistance of a cohesionless soil, caused by a collapse of the structure from shock or other type of strain.

LITTER -- A surface layer of loose organic debris in forests consisting of freshly fallen or slightly decomposed organic materials.

LOAMY -- Intermediate in texture and properties between fine-textured and coarse-textured materials.

LOOSE ROCK DAM -- A dam built of rock without the use of mortar, a rubble dam.

MEAN DEPTH (hydraulics) -- Average depth; cross-sectional area of a stream or channel divided by its surface or top width.

MEAN VELOCITY -- The average velocity obtained by dividing the flow rate discharge by the cross-sectional area for that given cross-section.

MEASURING WEIR -- A shaped notch through which water flow are measured.

MECHANICAL PRACTICES -- Conservation practices that primarily change the surface of the land or that store, convey, regulate, or dispose of runoff water without excessive erosion.

MOVEABLE DAM -- A moveable barrier that may be opened in whole or in part, permitting control of the flow of water through or over the dam.

MUCK SOIL -- (1) An organic soil in which the organic matter is well decomposed. (2) A soil containing 20%-50% organic matter.

MULCH -- A natural or artificial layer of plant residue or other materials, such as sand or paper, on the soil surface.

NATURAL GROUND SURFACE -- The ground surface in its original state before any grading, excavation, or filling.

NOISE POLLUTION -- The persistent intrusion of noise into the environment at a level that may be injurious to human health.

NORMAL DEPTH -- The depth of flow in an open conduit during uniform flow for the given conditions.

OPEN DRAIN -- A natural watercourse or constructed open channel that conveys drainage water.

OUTFALL -- The point where water flows from a conduit, stream, or drain.

OUTLET -- The point of water disposal from a stream, river, lake, tidewater, or artificial dam.

OUTLET CHANNEL -- A waterway constructed or altered primarily to carry water from man-made structures, such as terraces, tile lines, and diversions.

OVERFALL -- The abrupt change in stream channel elevation; the part of a dam or weir over which the water flows.

OVERHAUL -- The transportation of excavated material beyond a specified haul limit.

PARENT MATERIAL -- The unconsolidated mineral or organic matter from which the solum of soils has developed by pedogenic processes.

PEAK DISCHARGE -- The maximum instantaneous flow from a given storm condition at a specific location.

PERCOLATION -- The downward movement of water through soil, especially the downward flow of water in saturated or nearly saturated soil.

PERMEABILITY -- The capacity for transmitting a fluid.

PERMEABILITY, SOIL -- The quality of soil that enables water or air to move through it.

pH -- A numerical measure of the acidity or hydrogen ion activity. The neutral point is pH 7.0. All pH values below 7.0 are acid and all above are alkaline.

PIPE DROP -- A circular conduit used to convey water down steep grades.

PLASTIC SOIL -- A soil capable of being molded or deformed continuously and permanently by relatively moderate pressure.

- PLUNGE POOL** -- A device used to dissipate the energy of flowing water that may be constructed or made by the action of flowing.
- PRINCIPAL SPILLWAY** -- A water-conveying device designed to regulate the normal water level.
- PURE LIVE SEED (PLS)** -- A term used to express the quality of seed, even if it is not shown on the label. Expressed as a percentage of the seeds that are pure and will germinate. Determined by multiplying the percent of pure seed times the percent of germination and dividing by 100.
- RELIEF DRAIN** -- A drain designed to remove water from the soil in order to lower the water table and reduce hydrostatic pressure.
- RESTORATION** -- The process of restoring site conditions as they were before the land disturbance.
- RILL** -- A small intermittent watercourse with steep sides, usually only a few inches deep.
- RIPRAP** -- Broken rocks, cobbles, or boulders placed on earth surfaces, such as the face of a dam or the bank of a stream for protection against the action of water.
- RISER** -- The inlet portions of a drop inlet spillway that extend vertically from the pipe conduit barrel to the water surface.
- ROCK-FILL DAM** -- A dam composed of loose rock usually dumped in place, often with the upstream part constructed of hand-placed or derrick-placed rock, and faced with rolled earth or with an impervious surface of concrete, timber, or steel.
- RUNOFF (hydraulics)** -- That portion of the precipitation on a drainage area that is discharged from the area in stream channels.
- SCARIFY** -- To abrade, scratch or modify the surface; for example, to scratch the impervious seed coat of a hard seed or to break the surface of the soil with a narrow-bladed instrument.
- SEDIMENT** -- Solid material, both mineral and organic, that is in suspension, is being transported, or has been moved from its site of origin by air, water, gravity, or ice as a product of erosion.
- SEDIMENT BASIN** -- A depression formed from the construction of a barrier or dam built at a suitable location to retain sediment and debris.
- SEDIMENT DISCHARGE** -- The quantity of sediment transported through a stream cross-section in a given time.
- SEDIMENT POOL** -- The reservoir space allotted to the accumulation of submerged sediment during the life of the structure.
- SEEDBED** -- The soil prepared by natural or artificial means to promote the germination of seed and the growth of seedlings.
- SEEPAGE** -- (1) Water escaping through or emerging from the ground along an extensive line or surface. (2) the slow movement of gravitational water through the soil.
- SHEET FLOW** -- Water, usually storm runoff, flowing in a thin layer over the ground surface; also called overland flow.
- SIDE SLOPE** -- Generic term used to describe the slope of earth-moving operations, generally stated in horizontal to vertical ratio.
- SILT** -- (1) A soil separate consisting of particles between 0.05 and 0.02 millimeter in equivalent diameter. (2) A soil textural class.
- SKIMMER** -- A buoyant device that releases water from the surface of an impoundment.
- SLOPE** -- The degree of deviation of a surface from horizontal, measured in numerical ratio, percent, or degrees. Expressed as a ratio or

percentage, the first number is the horizontal distance (run) and the second is the vertical distance (rise), as 2:1 or 50 percent (rise/run X 100%). Expressed in degrees, it is the angle of the slope from the horizontal plane with a 90 degree slope being vertical (maximum) and 45 degrees being a 1:1 slope.

SOIL -- The unconsolidated mineral and organic material on the immediate surface of the Earth that serves as a natural medium for the growth of land plants.

SOIL HORIZON -- A layer of soil or soil material approximately parallel to the land surface and differing from adjacent genetically related layers.

SPILLWAY -- An open or closed channel, or both, used to convey excess water from a reservoir.

SPOIL -- Soil or rock material excavated from a canal, ditch, basin, or similar construction.

STABILIZATION -- The process of establishing an enduring soil cover of vegetation and/or mulch or other ground cover in combination with installing temporary or permanent structures to minimize transport of sediment by wind, water, ice, or gravity.

STABILIZED GRADE -- The slope of a channel at which neither erosion, nor deposition, occurs.

STAGE (hydraulics) -- The variable water surface or the water surface elevation above any chosen datum

STATE SOIL AND WATER CONSERVATION COMMISSION -- The state agency established by soil and water conservation district enabling legislation to assist with the administration of the provisions of that law.

STORM DRAIN OUTLET PROTECTION -- A device used to dissipate the energy of flowing water.

STORM FREQUENCY -- An expression or measure of how often a hydrologic event of a given size or magnitude should on an average occur, based on a reasonable sample.

STREAMBANKS -- The usual boundaries, not the flood boundaries, of a stream channel. Right and left banks are named facing downstream.

STRUCTURAL PRACTICES -- Soil and water conservation measures, other than vegetation, utilizing the mechanical properties of matter to change the surface of the land to store, regulate, or dispose of runoff to prevent excessive sediment loss. This includes, but is not limited to, riprap, sediment basins, dikes, level spreaders, waterways or outlets, diversions, grade stabilization structures, sediment traps, land grading, etc.

SUBSOIL -- The B horizons with distinct profiles.

SUBWATERSHED -- A watershed subdivision of unspecified size that forms a convenient natural unit.

TERRACE -- An embankment or combination of an embankment and channel across a slope to control erosion by diverting or storing surface runoff.

TILTH -- A soil's physical condition as related to its ease to work (till).

TOE (engineering) -- Terminal edge or edges of a structure.

TOPSOIL -- Earthy material used as top-dressing for house lots, grounds for large buildings, gardens, road cuts or similar areas. It has favorable characteristics for production of desired kinds of vegetation or can be made favorable.

TRASH RACK -- A structural device used to prevent debris from entering

a spillway or other hydraulic structure.

UNIFIED SOIL CLASSIFICATION SYSTEM (engineering) -- A classification system based on the identification of soils according to their particle size, gradation, plasticity index, and liquid limit.

UNIFORM FLOW -- A state of steady flow when the mean velocity and cross-sectional area are equal to all sections of each.

VEGETATIVE MEASURES -- Stabilization of erosive or sediment-producing areas by covering the soil with: (a) permanent seeding, producing long-term vegetative cover or (b) short-term seeding, producing temporary vegetative cover or (c) sodding, producing areas covered with a turf or perennial sod, forming grass.

WATER CONSERVATION -- The physical control, protection, management, and use of water resources in such a way as to maintain maximum sustained benefits to people, agriculture, industry, commerce and other segments of the economy.

WATER CONTROL -- The physical control of water by such measures as conservation practices on the land, channel improvement, and installation of structures for water retardation and sediment detention.

WATERCOURSE -- Any natural or artificial watercourse, stream, river, creek, channel, ditch, canal, conduit, drain, waterway, gully, ravine, or wash in which water flows either continuously or intermittently, and which has a definite channel, bed and banks, including any area adjacent thereto subject to inundation by reason of overflow or floodwater.

WATERSHED AREA -- All land and water within the confines of a drainage divide, or a water problem-area consisting in whole, or in part, of land needing drainage or irrigation.

WATERSHED MANAGEMENT -- Use, regulation, treatment of water and land resources of a watershed to accomplish stand objectives.

WATERWAY -- A natural course or constructed channel for the flow of water.

WEIR -- A device for measuring or regulating the flow of water.

This glossary was compiled from definitions supplied by the Georgia Soil and Water Conservation Commission, Natural Resources Conservation Service, Soil and Water Conservation Society of America, Resource Conservation Glossary and other state and federal publications.

Georgia Points of Contact

GSWCC: <https://gaswcc.georgia.gov>

GA EPD: <http://epd.georgia.gov>

DNR: www.georgiawildlife.com

GA DOT: www.dot.ga.gov

GFC: www.gfc.state.ga.us

USACE: <http://www.sas.usace.army.mil/>

NRCS: <http://www.nrcs.usda.gov>

GEORGIA SOIL & WATER CONSERVATION COMMISSION REGIONS



Region 1
1282 SR 53 Spur SW
Suite 300
Calhoun, GA 30701
(706) 624-1434

Region 2
4310 Lexington Road
Athens, GA 30603
(706) 552-4479

Region 3
151 Langston Chapel Road
Suite 700
Statesboro, GA 30459
(912) 681-5241

Region 4
3014 Heritage Road
Suite 1
Milledgeville, GA 301061
(478) 445-5766

Region 5
4344 Albany Highway
Dawson, GA 39842
(229) 995-6001

GEORGIA SOIL & WATER CONSERVATION DISTRICTS

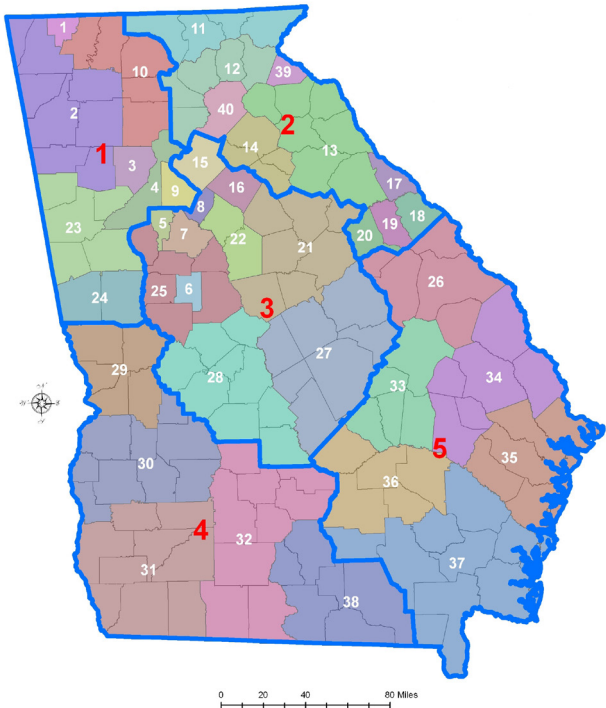

- | | |
|-------------------------------|-------------------------------|
| 1. Catoosa County | 21. Piedmont |
| 2. Coosa River | 22. Upper Ocmulgee River |
| 3. Cobb County | 23. West Georgia |
| 4. Fulton County | 24. Roosevelt |
| 5. Clayton County | 25. Towaliga |
| 6. Lamar County | 26. Brier Creek |
| 7. Henry County | 27. Central Georgia |
| 8. Rockdale County | 28. Ocmulgee River |
| 9. DeKalb County | 29. Pine Mountain |
| 10. Limestone Valley | 30. Lower Chattahoochee River |
| 11. Blue Ridge Mountain | 31. Flint River |
| 12. Upper Chattahoochee River | 32. Middle South Georgia |
| 13. Broad River | 33. Ohoopsee River |
| 14. Oconee River | 34. Ogeechee River |
| 15. Gwinnett County | 35. Coastal Georgia |
| 16. Walton County | 36. Altamaha |
| 17. Lincoln County | 37. Satilla River |
| 18. Columbia County | 38. Alapaha |
| 19. McDuffie County | 39. Stephens County |
| 20. Warren County | 40. Hall County |

**GEORGIA DEPARTMENT OF NATURAL
RESOURCES ENVIRONMENTAL
PROTECTION DIVISION**

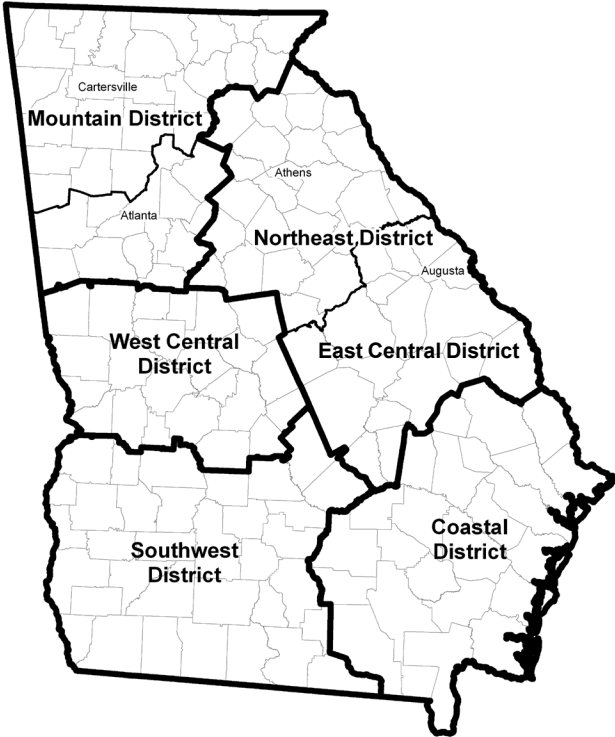

Mountain District (Atlanta)
4244 International Parkway
Atlanta, GA 30354
(404) 362-2671

Coastal District
400 Commerce Center Dr.
Brunswick, GA 31523
(912) 264-7284

Mountain District (Cartersville)
P.O. Box 3250
16 Center Road
Cartersville, GA 30120
(770) 387-4900

Southwest District
2024 Newton Road
Albany, GA 31701
(229) 430-4144

West Central District
2640 Shurling Drive
Macon, GA 31211
(478) 751-6612

East Central District
3525 Walton Way Ext.
Augusta, GA 30909
(706) 667-4343

Northeast District
745 Gaines School Road
Athens, GA 30605
(706) 369-6376

GEORGIA DEPARTMENT OF NATURAL RESOURCES WILDLIFE RESOURCES DIVISION FISHERIES MANAGEMENT

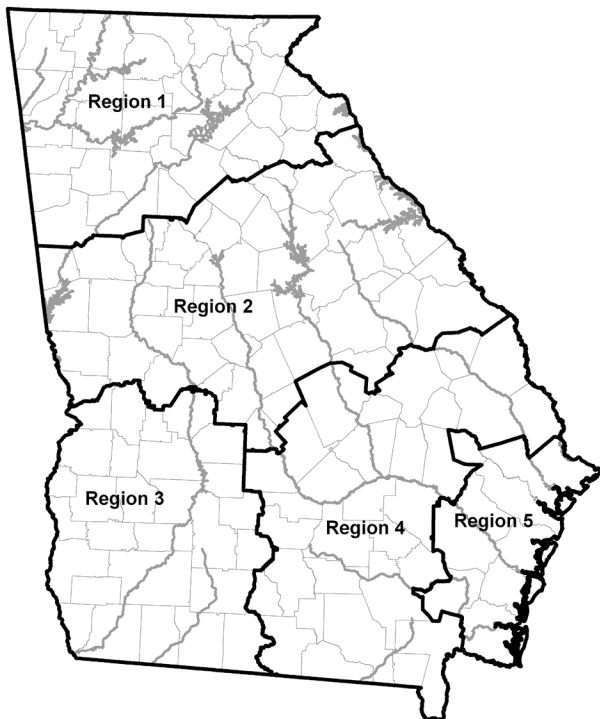

Region 1
2150 Dawsonville Highway
Gainesville, GA 30501
(770) 535-5498

Region 2
1014 Martin Luther King, Jr. Blvd.
Fort Valley, GA 31030
(478) 825-6151

Region 3
2024 Newton Road
Albany, GA 31701
(229) 430-4256

Region 4
108 Darling Ave.
Waycross, GA 31502
(912) 285-6094

Region 5
22814 Highway 144
Richmond Hill, GA 31324
(912) 727-2112

GEORGIA DEPARTMENT OF TRANSPORTATION

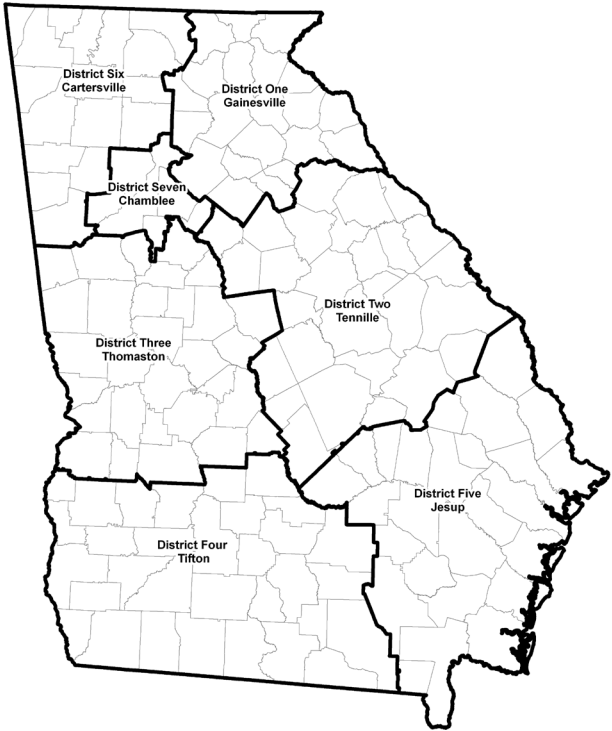

District 1
2505 Athens Hwy SE
Gainesville, GA 30507
(770) 531-5721

District 2
643 Hwy 15 S
Tennille, GA 31089
(478) 553-3301

District 3
115 Transportation Blvd
Thomaston, GA 30286
(706) 646-6900

District 4
710 West 2nd St.
Tifton, GA 31794
(229) 386-3280

District 5
204 North Highway 301
Jesup, GA 31546
(912) 427-5711

District 6
500 Joe Frank Harris Pkwy
Cartersville, GA 30120
(770) 387-3602

District 7
5025 New Peachtree Road
Chamblee, GA 30341
(770) 986-1011

GEORGIA FORESTRY COMMISSION

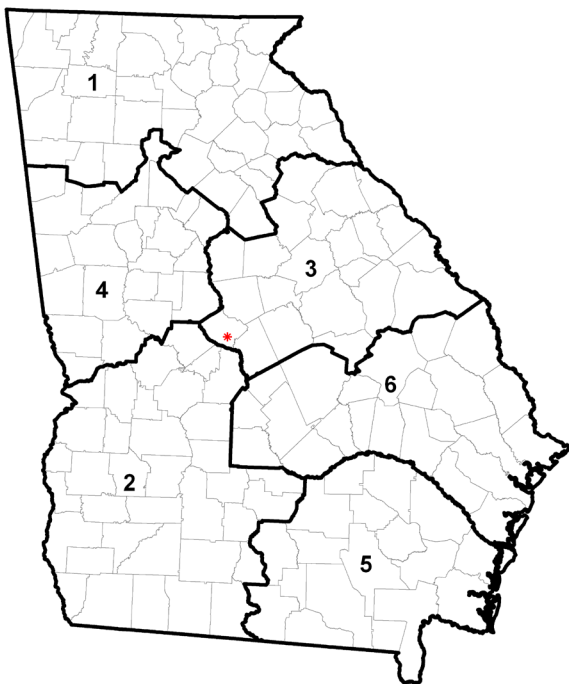

Coosa District (1)

Gainesville Office
3005 Atlanta Hwy
Gainesville, GA 30507
(770) 531-6043/6048

Rome Office
3086 Marth Berry Hwy NE
Rome, GA 30165
(706) 295-6021/6022

Flint District (2)

Camilla Office
3561 Hwy 112
Camilla, GA 31730
(229) 522-3580/3581

Americus Office
243 US Hwy 19 North
Americus, GA 31719
(229) 931-2436/2437

Oconee District (3)

Milledgeville Office
119 Hwy 49
Milledgeville, GA 31061
(478) 445-5164/5548

Washington Office
1465 Tignall Road
Washington, GA 30673
(706) 678-2015

Chattahoochee District (4)

Newnan Office
187 Corinth Road
Newnan, GA 30263
(770) 254-7218

Satilla District (5)

Waycross Office
5003 Jacksonville Hwy
Waycross, GA 31503
(912) 287-4915

Ogeechee District (6)

McRae Office
Route 1 Box 67
Helena, GA 31037
(229) 868-3385

Statesboro Office
18899 US Hwy 301 North
Statesboro, GA 30461
(912) 681-0490/0496

UNITED STATES ARMY CORPS OF ENGINEERS AREA OFFICES

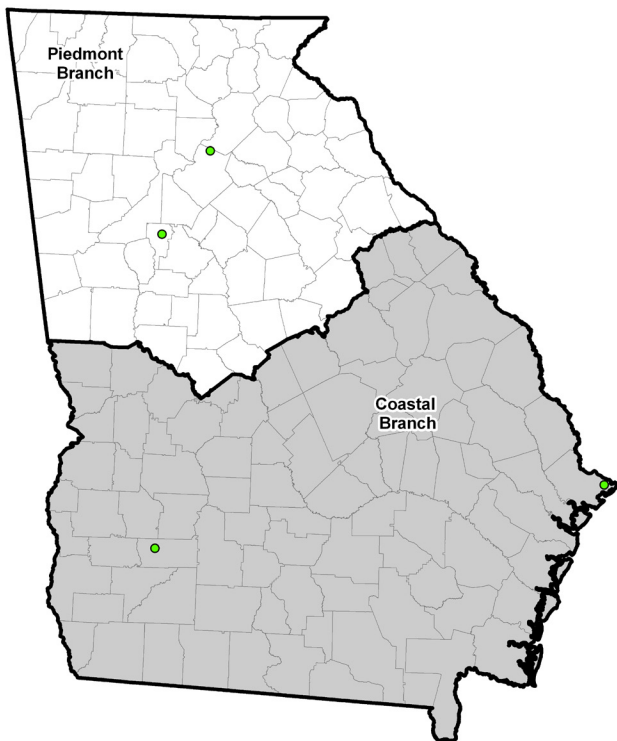

Coastal Branch
100 W. Oglethorpe Ave
Savannah, GA 31401
(912) 652-5279

Piedmont Branch
1590 Adamson Parkway
Suite 200
Morrow, GA 30260
(678) 422-2735

NATURAL RESOURCES CONSERVATION SERVICE AREA OFFICES

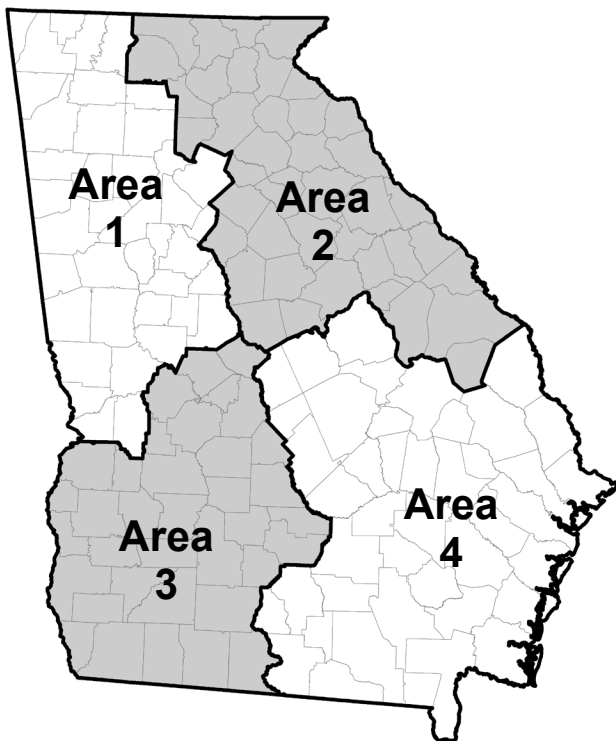

Area 1
Federal Building Room G-27
201 West Solomon St.
Griffin, GA 30224
(770) 227-1026

Area 2
Federal Building
355 East Hancock Ave.
Athens, GA 30601
(706) 546-2039

Area 3
Plant Materials Center
295 Morris Drive
Americus, GA 31709
(229) 924-0544

Area 4
Federal Building Room 214
601 Tabeau St.
Waycross, GA 31502
(912) 283-5598

COMMONLY USED ACRONYMS

BMP: Best Management Practices

CWA: Clean Water Act

DNR: Department of Natural Resources

EPA: Environmental Protection Agency

EPD: Environmental Protection Division

ES&PC Plan: Erosion, Sedimentation & Pollution Control Plan

FEMA: Federal Emergency Management Agency

GESA: Georgia Erosion & Sediment Control Act

GFC: Georgia Forestry Commission

GSWCC: Georgia Soil & Water Conservation Commission

LDA: Land Disturbing Activity

LIA: Local Issuing Authority

MLRA: Major Land Resource Area

NOI: Notice of Intent

NOT: Notice of Termination

NPDES: National Pollutant Discharge Elimination System

NRCS: Natural Resource Conservation Service

NTU: Nephelometric Turbidity Units

O.C.G.A.: Official Code of Georgia Annotated

SWCD: Soil & Water Conservation District

USDA: United States Department of Agriculture

Comments: _____

Comments: _____
